

LATEST IN TELEVISION - SERVICING - AUDIO

RADIO — ELECTRONICS

HUGO GERNSBACH, Editor

BUS AND STORE FM

—
ADD A SLAVE UNIT
TO YOUR TELEVISER

—
A SYNCHRODYNE SET



APR

1957

30¢

U. S. and
CANADA

↑
SIGNAL CORPS RADIO TRAINING — SEE ELECTRONICS SECTION

You get all five



...with RCA Batteries

1. Top Brand Acceptance

... makes selling easy

The *selling power* of the RCA Trade-mark makes it *easy* for you to move RCA Batteries . . . and gain a satisfied customer every time.

Remember, too, that RCA Batteries are *radio-engineered* for *extra* listening hours . . . provide a type for practically every renewal requirement.

So—starting now—push RCA Batteries. Build a profitable repeat business with virtually no competition from non-radio outlets.

See your RCA Battery Distributor for fast, reliable service.

2. Radio Trade Distribution

3. Completely Rounded Line

4. Radio-Engineered Quality

5. Super Selling Aids

*The Batteries for
the Radio Trade!*



RADIO CORPORATION of AMERICA

RADIO BATTERIES

HARRISON, N. J.

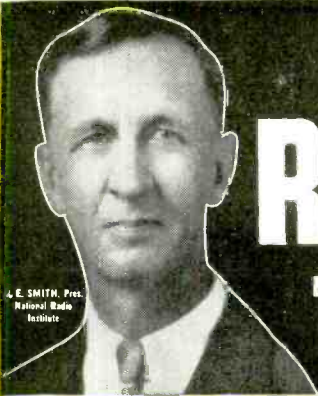

J. E. SMITH, Pres. National Radio Institute

BE A SUCCESS AS A RADIO-TELEVISION TECHNICIAN

2 FREE BOOKS SHOW HOW MAIL COUPON

America's Fast Growing Industry Offers You

VETERANS

Get this training under G.I. Bill
MAIL COUPON!

1. EXTRA MONEY IN SPARE TIME

Many students make \$5, \$10 a week extra fixing neighbors' Radios in spare time while learning. The day you enroll I start sending you SPECIAL BOOKLETS to show you how to do this. Tester you build with parts I send helps you service sets. All equipment is yours to keep.

2. GOOD PAY JOB

Your next step is a good job installing and servicing Radio-Television sets or becoming boss of your own Radio-Television sales and service shop or getting a good job in a Broadcasting Station. Today there are over 90,000,000 home and auto Radios. 3100 Broadcasting Stations are on the air. Aviation and Police Radio, Micro-Wave Relay, Two-Way Radio are all expanding, making more and better opportunities for servicing and communication technicians and FCC licensed operators.

3. BRIGHT FUTURE

And think of the opportunities in Television! In 1950 over 5,000,000 Television sets were sold. By 1954 authorities estimate 25,000,000 Television sets will be in use. Over 100 Television Stations are now operating, with experts predicting 1,000. Now is the time to get in line for success and a bright future in America's fast-growing industry. Be a Radio-Television Technician. Mail coupon for Lesson and Book—FREE.



I TRAINED THESE MEN

 Chief Engineer, Police Radio "Soon after finishing the N. R. I. course, worked for servicing shop. Now I am Chief Engineer of WCLN, WNNR, WSPK, two-way FM Police Radio (stations) S. W. DINDWIDDIE, Jacksonville, Ill.	 Specialist in Television "Have my own shop. Am authorized serviceman for 5 large manufacturers and do re-vicing for 7 dealers. N. R. I. has enabled me to build an enviable reputation on Television." F. MILLER, Maumee, O.
 Graduate Business Salary "Am with Station WKDO as transmitter operator. Have more than doubled salary since starting Radio. Future looks bright. N. R. I. has been constant help to me." A. HERR, New Cumberland, Pa.	 Years of Success with shop "Am proud of my own shop and have over 500 customers. My profits average about \$150 a month. Have had years of successful experience and I still praise N. R. I. training. J. H. ANDERSON, Atlanta, Ga.
 118 Hours in Spare Time "Before finishing your course I earned as much as \$10 a week in Radio servicing, at home in my spare time. I recommend N. R. I. to everyone who shows interest in Radio." S. J. PETRUS, Miami, Fla.	 My First Job Through N. R. I. "My first job was operator with KBLR, obtained for me by your Graduate Service Dept. I am now Chief Engineer of Police Radio Station WQOX." T. S. NOTTON, Hamilton, Ohio.

I Will Train You at Home

Read How You Practice Servicing or Communications with Many Kits of Parts You Get!



YOU BUILD this modern Radio (above) as part of my Servicing Course. Build this complete, powerful Radio Receiver that brings in local and distant stations. N. R. I. gives you ALL the Radio parts—speaker, tubes, chassis, transformer, sockets, loop antenna, EVERYTHING you need. You use material to get practical Radio experience. Make EXTRA money fixing neighbors' Radios in spare time while training.

YOU MEASURE current, voltage (AC, DC and RF), resistance and impedance in circuits with Electronic Multitester (above right) you build as part of my Servicing or Communications Course.

YOU BUILD the Transmitter (right). As part of my Communications Course, I SEND YOU parts to build this low-power broadcasting transmitter. You learn how to put a station "on the air," perform procedures demanded of Broadcast Station operators, make many practical tests.

YOU BUILD this Wavimeter (below) in my Communications Course with parts I send you. Use it to determine frequency of operation and make other tests on transmitter currents. You conduct many interesting experiments.

This is just part of the equipment my students build. You keep all parts I send.

NOW! Advanced Television Practice

New, special TV kits furnished to build high-definition SCOPE... RF OSCILLATOR with flyback power supply... complete TV SET... many other units. You see pulse, trapezoidal, saw-tooth wave forms. Get valuable PRACTICAL EXPERIENCE locating and correcting TV troubles. Mail coupon for facts and pictures.

Keep your job while training at home. Hundreds I've trained are successful RADIO-TELEVISION TECHNICIANS. Most had no previous experience; many no more than grammar school education. Learn Radio-Television principles from illustrated lessons. Get PRACTICAL EXPERIENCE—build valuable Electronic Multitester for conducting tests; also practice servicing Radios or operating Transmitters—experiment with circuits common to Radio and Television. At left is just part of the equipment my students build with many kits of parts I furnish. All equipment is yours to keep. Many students make \$5, \$10 a week extra fixing neighbors' Radios in spare time.

Mail Coupon For 2 Books FREE
Act Now! Send for my FREE DOUBLE OFFER. Coupon entitles you to actual lesson on Servicing; shows how you learn Radio-Television at home. You'll also receive my 64-page book, "How to Be a Success in Radio-Television." You'll read what my graduates are doing, earning; see photos of equipment you practice with at home. Send coupon in envelope or paste on postal. J. E. SMITH, Pres., Dept. 10F, National Radio Institute, Washington 9, D. C. Our 38th year.

Good for Both—FREE

Mr. J. E. SMITH, President, Dept. 10F National Radio Institute, Washington 9, D. C.
Mail me Sample Lesson and 64-page Book about How to Win Success in Radio-Television. Both FREE. (No salesman will call. Please write plainly.)

Name..... Age.....
Address.....
City..... Zone..... State.....
 Check if Veteran Approved Under G. I. Bill

The ABC's of SERVICING

How to Be a Success in RADIO-TELEVISION

RADIO — ELECTRONICS

formerly RADIO-CRAFT

MEMBER
AUDIT BUREAU OF CIRCULATIONS

Hugo Gernsback, Editor-in-Chief

M. Harvey Gernsback, Editorial Director

Fred Shunaman, Managing Editor
Robert F. Scott, W2PWG, Technical Editor
Manfred Wentzel, Associate Editor

I. Queen, Editorial Associate
Angie Pascale, Production Manager
Wm. Lyon McLaughlin, Tech. Illustration Director

Lee Robinson, General Manager
John J. Lamson, Sales Manager

G. Aliquo, Circulation Manager
Robert Fallath, Promotion Manager

Incorporating
SHORT WAVE CRAFT* TELEVISION NEWS*
RADIO & TELEVISION
*Trademark registered U. S. Patent Office

CONTENTS

APRIL, 1951

Editorial (Page 23)

The Qualified Service Technician.....by Hugo Gernsback 23

Television (Pages 24-29)

Video Slave for Remote Televiewing.....by John Shewbrooks 24
New Video Circuits in Modern TV Sets.....by Edward M. Noll 26
Television Service Clinic.....by Walter H. Buchsbaum 28

FM (Pages 30-32)

Supersonic-Controlled FM for Bus- and Storecasting
by W. H. Collins 30

Servicing-Test Instruments (Pages 33-43)

Emission Type Tester Checks Subminiatures
by Edwin N. Kaufman 33
Signal Tracing System Eliminates Time Waste...by John D. Burke 34
Low-Cost Oscilloscope is Easy to Build...by Robert C. Sanford 36
Designing a Signal Generator.....by R. G. Young 39
Noise Suppressors Aid Ignition..... 40
Fundamentals of Radio Servicing, Part XXVI (Conclusion)
by John T. Frye 41
Fence Controller Repair.....by John W. Cook 43

Construction (Pages 44-47)

A Practical Synchrodyne.....by John W. Straede 44
Compact Strobotron Pulsar.....by R. L. Ives 45
A.C. Supply for Mobile Use.....by Paul W. Streefer 47

Electronics (Pages 48-60)

Tristimulus Color Photometer.....by Eric Leslie 48
Signal Corps Radio Training (Cover Feature)..... 50
The Hypnotron.....by Mohammed Ulysses Fips, I.R.E. 52
How An Electric Brain Works, Part VII
by Edmund C. Berkeley and Robert A. Jensen 54

Audio (Pages 62-69)

Electronics and Music, Part X.....by Richard H. Dorf 62

Theory and Engineering (Pages 70-72)

New Printed Circuits Make for Compactness...by H. E. Moore 70

New Design (Pages 92-93)

Tubes of the Month..... 92

Departments

The Radio Month..	10	Association News ..	94
Radio Business.....	14	Technotes	96
New Patents.....	76	New Devices	100
Question Box	80	Miscellany	102
Radio-Electronic		People	106
Circuits	88	Communications ...	109
Try This One.....	90	Book Reviews	111

ON THE COVER:

Instructor and student at work in the semi-darkened radar classroom of the Signal Corps at Fort Monmouth, N. J.
Kodachrome by Avery Slack

DESIGNED FOR TV SERVICING



The best way to avoid costly service callbacks on TV electrolytic capacitor replacement jobs is to use Sprague 'lytics.

Actual service records prove they are tops for keeping you out of trouble with service customers—by keeping their TV sets working right!

And Sprague has the most complete listing of every type of television electrolytic.

Write for your catalog today!

SPRAGUE PRODUCTS COMPANY
DISTRIBUTORS' DIVISION OF THE SPRAGUE ELECTRIC COMPANY
81 MARSHALL ST., NORTH ADAMS, MASS.

RADIO-ELECTRONICS, April 1951, Volume XXII, No. 7. Published monthly. Publication Office: Erie Ave., P to G Streets, Philadelphia 32, Pa. Entered as second class matter September 27, 1948, at the post office at Philadelphia, Pa., under the Act of March 3, 1879. SUBSCRIPTION RATES: In U. S. and Canada, in U. S. possessions, Mexico, South and Central American countries, \$3.50; \$6.00 for two years; \$8.00 for three years; single copies 30c. All other foreign countries \$4.50 a year, \$8.00 for two years, \$11.00 for three years. Allow one month for change of address. When ordering a change please furnish an address stencil impression from a recent wrapper. RAD-CRAFT PUBLICATIONS, INC. Hugo Gernsback, Pres.; M. Harvey Gernsback, Vice-Pres.; G. Aliquo, Sec'y. Contents copyright, 1951, by Radcraft Publications, Inc. Text and illustrations must not be reproduced without permission of copyright owners. EDITORIAL and ADVERTISING OFFICES, 25 West Broadway, New York 7, N. Y. Tel. REctor 2-9690. BRANCH ADVERTISING OFFICES: Chicago: 520 N. Michigan Ave. Telephone SUPERior 7-1796. Los Angeles: Ralph W. Harker, 1127 Wilshire Blvd., Tel. MA 6-1271. San Francisco: Ralph W. Harker, 582 Market St., Tel. GARfield 1-2481. FOREIGN AGENTS: Great Britain: Atlas Publishing and Distributing Co., Ltd., London E.C.4. Australia: McGill's Agency, Melbourne. France: Brentano's, Paris 2e. Holland: Trilectron, Heemstede. Greece: International Book & News Agency, Athens. So. Africa: Central News Agency, Ltd., Johannesburg; Capetown: Durban, Natal. Universal Book Agency, Johannesburg. Middle East: Steimatzy Middle East Agency, Jerusalem. India: Broadway News Centre, Dadar, Bombay #14. K. L. Kannappa Mudalliar, Madras 2. Pakistan: Paradise Book Stall, Karachi 3. POSTMASTER: If undeliverable send form 3578 to: RADIO-ELECTRONICS, 25 West Broadway, New York 7, N. Y.

GET INTO RADIO-TELEVISION ELECTRONICS By Shop-Method Home Training

GOOD JOBS AWAIT THE TRAINED RADIO-TV TECHNICIAN

There is a place for you in the great Radio-Television-Electronics industry when you are trained as National Schools will train you at home!

Trained technicians are in growing demand at good pay—in manufacturing, broadcasting, television, communications, radar, research laboratories, home Radio-TV service, and other branches of the field. National Schools Master Shop-Method Home Training, with newly added lessons and equipment, trains you in your spare time, right in your own home, for these fascinating opportunities. **OUR METHOD IS PROVED BY THE SUCCESS OF NATIONAL SCHOOLS TRAINED MEN, ALL OVER THE WORLD, SINCE 1905.**

EARN WHILE YOU LEARN

Many National students pay for all or part of their training with spare time earnings. We'll show you how you can do the same! Early in your training, you receive "Spare-time Work" Lessons which will enable you to earn extra money servicing neighbors' and friends' Radio and Television receivers, appliances, etc.

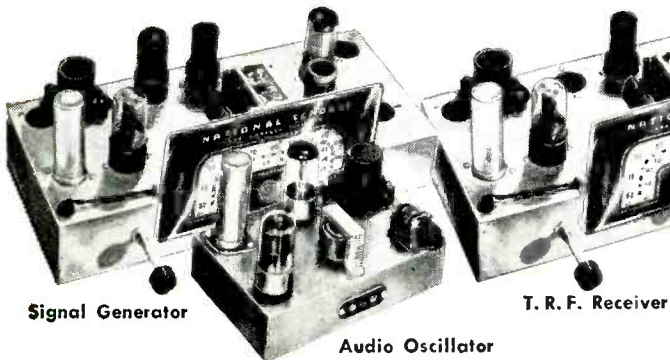

Signal Generator

Audio Oscillator

T. R. F. Receiver

National Schools Training Is All-Embracing

National Schools prepares you for your choice of many job opportunities. Thousands of home, portable, and auto radios are being sold daily—more than ever before. Television is sweeping the country, too. Co-axial cables now under construction will soon bring Television to every city, town, and farm! National Schools' complete training program qualifies you in all fields. Read this partial list of opportunities for trained technicians:

- Business of Your Own • Broadcasting
- Radio Manufacturing, Sales, Service • Telecasting
- Television Manufacturing, Sales, Service
- Laboratories: Installation, Maintenance of Electronic Equipment
- Electrolysis, Call Systems
- Garages: Auto Radio Sales, Service
- Sound Systems and Telephone Companies, Engineering Firms
- Theatre Sound Systems, Police Radio
- And scores of other good jobs in many related fields.

TELEVISION TRAINING

A complete series of up-to-the-minute Television lessons is an important part of your course. They cover all phases of Television repairing, servicing and construction. The same lesson texts used by resident students in our own modern and complete Television broadcast studios, laboratories and classrooms.

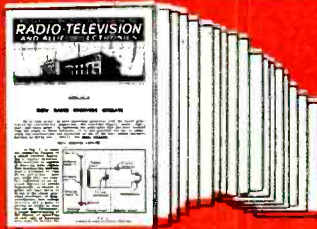

MASTER ALL PHASES!

Get Master Shop-Method Home Training from an Established Practical Resident School with its own Training Shops, Laboratories, and Studios—and almost 50 Years of Successful Experience in Training Ambitious Men.

We Bring National Schools To You

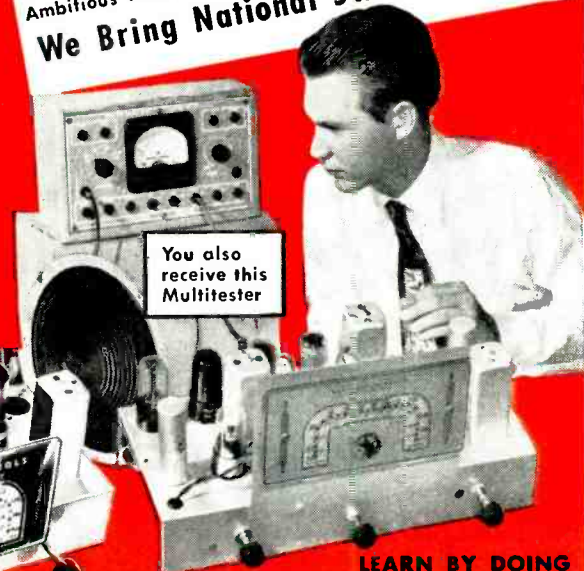

You also receive this Multitester

LEARN BY DOING

You receive and keep all the modern equipment shown above, including tubes and valuable, professional quality Multitester. No extra charges. You build the fine Superheterodyne Receiver with parts we send you.

FREE!

These 2 Free Books give you all the facts. Send today for National Schools' new, Illustrated Book of Opportunity in Radio-Television-

Electronics, and an actual Sample Lesson. No cost—no obligation. Use the coupon now—we'll answer by return airmail.

APPROVED FOR VETERANS AND NON-VETERANS
Check coupon below

Both Resident & Home Study Courses offered



NATIONAL SCHOOLS

LOS ANGELES 37, CALIF. • EST. 1905

FIND OUT NOW... MAIL COUPON TODAY

National Schools, Dept. 4-RE
4000 South Figueroa Street
Los Angeles 37, California

Mail in envelope or paste on penny postal.

Send me your FREE book "Your Future in Radio" and the sample lesson of your course. I understand no salesman will call on me.

NAME _____ AGE _____

ADDRESS _____

CITY _____ ZONE _____ STATE _____

Check here if Veteran of World War II

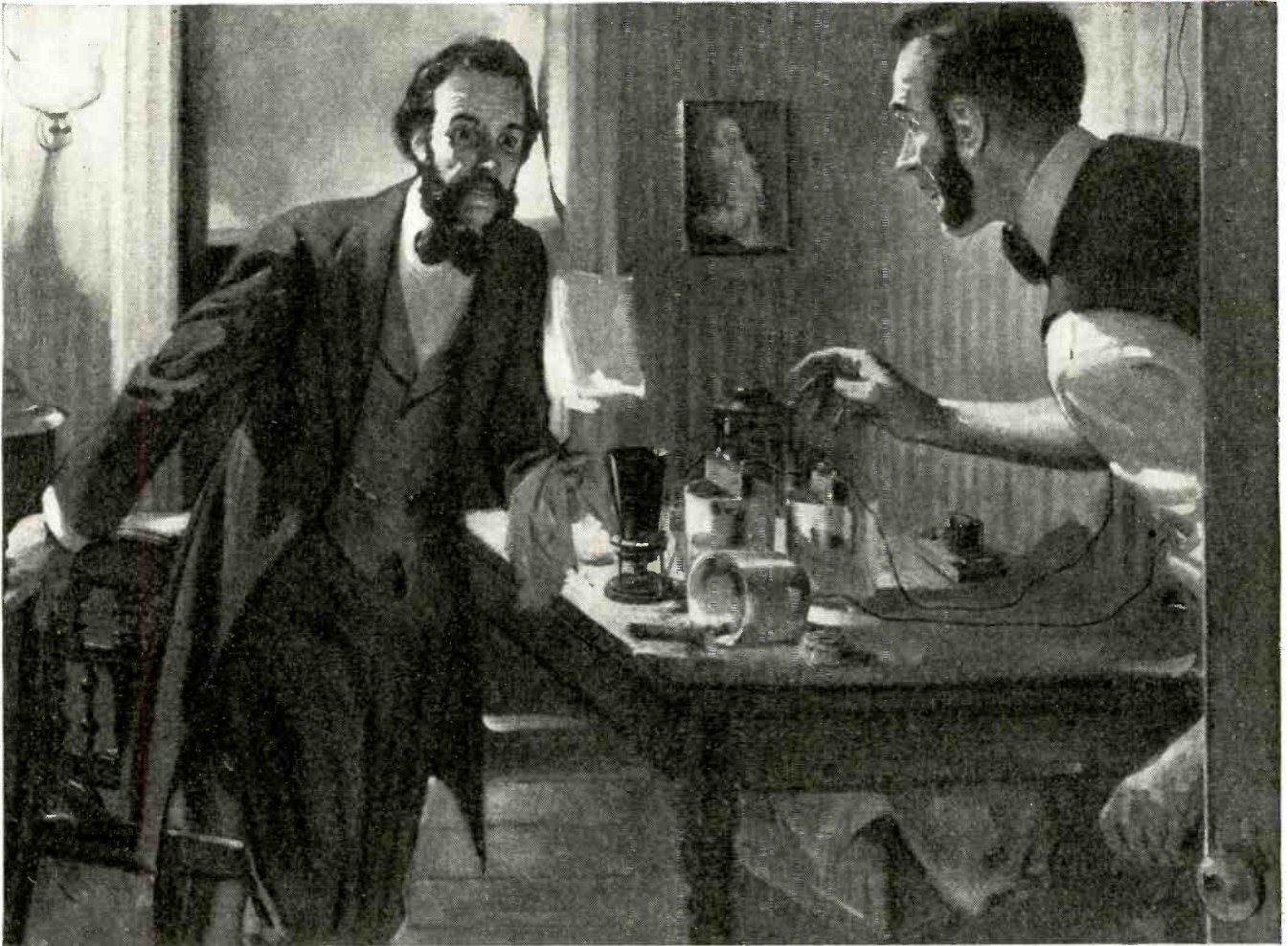

"Mr. Bell, I heard every word you said — distinctly!" Thus, on March 10, 1876, Alexander Graham Bell (left) learned that his invention had transmitted the first intelligible speech.

75 Years of Tomorrows

Like today's telephone, Alexander Graham Bell's invention was a product of research. For several years Bell had been investigating speech and hearing, and devising methods and apparatus for the electrical communication of intelligence. No one had transmitted speech sounds electrically but Bell saw that it must be possible—given the proper instruments.

One day, while experimenting with his harmonic telegraph, Bell's alert ear caught an unexpected sound in the re-

ceiver. His trained mind told him that here at last was the proof that sound waves could travel as their facsimile in electric waves. Then followed a year of development, and in 1876, as shown above, he transmitted the first intelligible speech by telephone.

During the next three-quarters of a century, the telephone research which Bell started has grown and expanded to serve your telephone system . . . often fruitfully overflowing into other fields of electrical communication. In today's

Bell Telephone Laboratories, promising ideas find the right skills to bring them to life. Through skilled manufacturing by Western Electric Company and skilled operation by the telephone company they are brought to the service of the telephone user.

The high quality of your telephone today, its fine, swift service at reasonable cost, are the products of work in the telephone laboratories in the past. The greater value you may expect in the future is taking form there already.



BELL TELEPHONE LABORATORIES

Exploring and Inventing, Devising and Perfecting, for Continued Improvements and Economies in Telephone Service

RADIO-ELECTRONICS for

**Jobs are looking for men again!
Qualified Technicians Needed for
TELEVISION
and FM
SERVICING**



**TELEVISION
SERVICEMEN
\$100 PER WEEK**

Inside or outside men, with or without car. We pay car expenses! Modern, air-conditioned shop! Vacation with pay! Group hospitalization! 20% employe discount privilege! Time and one-half for all overtime work! Wonderful opportunity for advancement!

Box 474-E, Star.

1949 Mercury 912 D st. n.e., FR. 0729.

TELEVISION INSTALLERS

One of Washington's largest television installation companies has an opening for a thoroughly experienced crew. This is a permanent job, averaging better than

\$150 PER WEEK.

Must have car, ladders, tools. EDWARD M. MEYER CO., 6230 3rd st. n.w. No. 7.

TELEVISION SERVICEMAN, TV experience for home service calls, car allowance, excellent pay, permanent

CREI HOME STUDY
can help you to better jobs
in servicing or Armed Services!

ADS LIKE these testify to the demand that exists for qualified TV technicians. As one well-informed industry spokesman puts it, "Technicians may soon be as scarce as certain tubes." With the electronics industry expanding, and with growing military demands cutting sharply into the available supply of skilled personnel, now is certainly the time to improve your electronics know-how. And if you're headed for the Armed Services, your improved technical ability can be recognized and rewarded with interesting supervisory work at higher ratings in vital radar, navigation, or communications units.

Anyone already in the field—if he is to get ahead—can't depend on hit-and-miss methods for TV servicing. Practical knowledge is required. CREI home study offers just the practical course you need to

qualify for the well-paid technical jobs. Designed by teaching specialists—the same group which has made the CREI Residence School outstanding—this practical course is kept up-to-date through daily contact with CREI's affiliated retail sales-and-servicing stores (one of Washington's largest TV retailers).

Now is unquestionably the time to prepare. If you want promotion, more money, and the kind of training that is respected by industry and the Armed Services, investigate CREI. Send for—and study—the free booklet offered below. The sooner you begin your training, the better off you'll be—in TV servicing work, or in military service. The cost is nominal for this training, the terms easy. Send for complete data—right now!

THE THREE BASIC CREI COURSES:

- ★ **PRACTICAL RADIO ENGINEERING**
Fundamental course in all phases of radio-electronics
- ★ **PRACTICAL TELEVISION ENGINEERING**
Specialized training for professional radiomen
- ★ **TELEVISION AND FM SERVICING**
Streamlined course for men in "top-third" of field

ALSO AVAILABLE AS RESIDENCE SCHOOL COURSES

**CAPITOL RADIO
ENGINEERING INSTITUTE**

An Accredited Technical Institute Founded in 1927
Dept. 144C, 16th & Park Ed., N. W. Washington 10, D. C.
Branch Office: San Francisco, 760 Market St.



MAIL COUPON FOR FREE BOOKLET

CAPITOL RADIO ENGINEERING INSTITUTE
Dept. 144C, 16th & Park Road, N. W., Washington 10, D. C.

Gentlemen: Send booklet, "Your Future in the New World of Electronics," together with details of your home study training, CREI self-improvement program and outline of course. I am attaching a brief resume of my experience, education and present position.

- Check Field of Greatest Interest:
- | | |
|---|---|
| <input type="checkbox"/> TV, FM & Advanced AM Servicing | <input type="checkbox"/> Aeronautical Radio Engineering |
| <input type="checkbox"/> Practical Television Engineering | <input type="checkbox"/> Broadcast Radio Engineering (AM, PM, TV) |
| <input type="checkbox"/> Practical Radio Engineering | <input type="checkbox"/> Radio-Electronics in Industry |
- If Residence School in Wash., D. C., Preferred, Check Here

NAME _____ AGE _____
ADDRESS _____
CITY _____ ZONE _____ STATE _____

THE CATHODE—

THE WORLD'S GREATEST PAINTER—

SHARES

RAYTHEON'S 101



RAYTHEON TELEVISION PICTURE TUBES



are given 101 basic tests and checks to insure their quality. The cathode pictured produces the electron ray that paints the picture on the tube's screen and will perform perfectly, because it has passed its share of Raytheon's 101 Tests.

This strict control of quality means Raytheon Picture Tubes, like all Raytheon Products, are precisely right both electrically and mechanically. As pioneers in the development and manufacture of almost every type of electronic tube, Raytheon has the know-how and skill that makes Raytheon Picture Tubes *Right for Sight!*

Add precision workmanship to advanced design and you'll readily realize why you're always right if you use Raytheon Picture Tubes for every replacement and conversion job.

Ask your Raytheon Tube Distributor about these Quality Raytheon Picture Tubes.

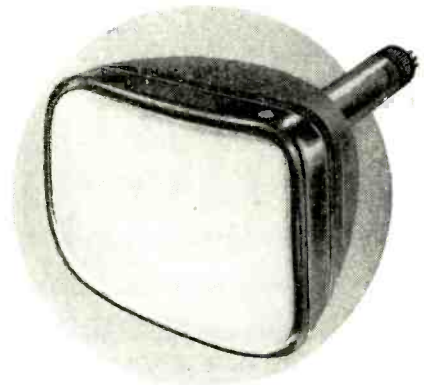

Right for Sight!



Excellence in Electronics

RAYTHEON MANUFACTURING COMPANY

Receiving Tube Division

Newton, Mass., Chicago, Ill., Atlanta, Ga., Los Angeles, Calif.

RADIO AND TELEVISION RECEIVING TUBES, CATHODE RAY TUBES, SPECIAL PURPOSE TUBES, SUBMINIATURE TUBES, MICROWAVE TUBES

CORPORATION

RADIO-ELECTRONICS for

NOW... GET EVERYTHING YOU NEED TO LEARN AND MASTER

TELEVISION

RADIO-ELECTRONICS

...AT HOME!

Use REAL commercial-type equipment to get practical experience



Here's the REAL THING!

SET UP YOUR OWN HOME LABORATORY



Oscilloscope

R-F Signal Generator

6-Tube Radio

Multimeter

HOME MOVIES

ABOVE: Build and keep a real 16 INCH commercial TV receiver. Optional after completing regular training at slight additional cost.

D.T.I., ALONE, INCLUDES BOTH MOVIES and HOME LABORATORY
 In addition to easy-to-read lessons, you get the use of HOME MOVIES — an outstanding training advantage — plus 16 big shipments of Electronic parts. Perform over 300 fascinating experiments for practical experience. Build and keep real commercial-type test equipment shown at left.

MODERN LABORATORIES

If you prefer, get all your preparation in our new Chicago Training Laboratories—one of the finest of its kind. Ample instructors, modern equipment. Write for details!

MILITARY SERVICE!

If you're subject to military service, the information we have for you should prove doubly interesting. Mail coupon today.

Your future deserves and needs every advantage you can give it! That's why you owe it to yourself to find out about one of the most COMPLETE, practical and effective ways now available to prepare AT HOME for America's billion dollar opportunity field of TELEVISION-RADIO-ELECTRONICS. See how you may get and keep the same type of basic training equipment used in one of the nation's finest training laboratories... how you may get real STARTING HELP toward a good job or your own business in Television-Radio-Electronics. Mail the coupon today for complete facts — including 89 ways to earn money in this thrilling, newer field.

Get BOTH of these information packed publications FREE!



ACT NOW! MAIL COUPON TODAY!

DeFOREST'S TRAINING, INC., Dept. RE-4-H
 2533 N. Ashland Ave., Chicago 14, Ill.

Without obligation, I would like your late News-Bulletin showing 89 ways to earn money in Television-Radio-Electronics... and how I may prepare to get started in this thrilling field.

Name..... Age.....
 Street..... Apt.....
 City..... Zone..... State.....

De FOREST'S TRAINING, INC.
 CHICAGO 14, ILLINOIS
 A De VRY INSTITUTION



Music—sweet music to his ears!

And why not? A satisfied customer has telephoned—yes, actually telephoned—to thank this service-dealer for the swell repair job on his TV sets.

Your customers may not take the trouble very often to do this, but you can bet your last dime that a dissatisfied customer will lose no time in telling you what he thinks. This means call-backs on which you lose time, money, and reputation.

The trick, of course, is to eliminate call-backs. Unfortunately, you can't eliminate them *all*. But, you can keep them to a minimum by using only parts on which you can stake your reputation.

Look at any tube marked TUNG-SOL. There is the same tube—the same performance standards—the same dependability which eight out of ten leading set manufacturers use for initial equipment. All TUNG-SOL tubes are made to meet their requirements. So, when you make replacements with TUNG-SOL tubes, you're putting back into the set the same high quality with which it left the factory.

This TUNG-SOL "one standard" policy safeguards your service work, your prestige and your profit.

Tell your distributor's salesman you'd rather have TUNG-SOL tubes.

TUNG-SOL LAMPWORKS INC., NEWARK 4, N.J.
Sales Offices: Atlanta, Chicago, Dallas, Denver,
Detroit, Los Angeles, Newark



TUNG-SOL
RADIO AND TV TUBES

ONE STANDARD—The best that can be made
For Initial Equipment and Replacement

CIGAR-SIZE TV TUBES, thousands of times as bright as today's TV screens, television pickup tubes 100 times as sensitive as the human eye, and television-telephone service were predicted by Philo T. Farnsworth, the father of electronic television, at a recent joint meeting of the IRE and AIEE in Fort Wayne, Indiana.

While setting no timetable for these developments, Mr. Farnsworth said, "I believe that the trend in television receiver tubes will be toward the very small rather than to larger sizes, since the visible image will not be limited by the size of the tube. As tubes approach their potential performance, projection television will come into its own and may relegate direct-view tubes to scientific museums." He predicted a receiver tube less than six inches long and an inch in diameter with a screen brightness 50,000 times brighter than today's direct-view tubes.

Mr. Farnsworth also said that picture tubes of the future would operate without any visible scanning lines and that camera tubes would be able to "see" in the infra-red region and pick up images in total darkness. He forecast that television would move up into the higher frequencies, eventually reaching 3,000 mc. Because of the high directivity at these frequencies, several stations in a given area could operate on the same channel and highly directive receiving antennas would make it possible for the viewer to select the station of his choice without the risk of co-channel interference.

DEEP SEA CABLES with self-contained amplifiers recently have been laid in the 115-mile stretch between Key West, Florida, and Havana, Cuba. Developed at the Bell Telephone Laboratories, the two coaxial-type cables—one for northbound and the other for southbound traffic—each have built-in amplifiers spaced about 40 miles apart, and they rest on the ocean floor. The two cables provide 24 high-quality talking paths between the two cities.

The cable bulges from its ordinary 1-inch diameter to about 3 inches where the amplifiers are located. The cable design called for many entirely new techniques, including the development of vacuum tubes that will operate unattended for as long as 20 years and a cable sufficiently flexible for deep water laying but rugged enough to withstand the tremendous pressures over a mile below the ocean's surface.

DAYLIGHT LUMINESCENCE is a phenomenon recently discovered by Dr. Byron E. Cohn, physicist at the University of Denver. By flying light-sensitive instruments attached to helium balloons to over 100,000 feet above the earth's surface, Dr. Cohn found that the sky's brightness at those altitudes was about five times as bright as it should be according to present theories. His explanation for the phenomenon is that ultraviolet rays from the sun give positive charges to the sparse air particles. These combine so vigorously with electrons that they produce light, thus sur-

rounding the earth with a dome of light.

This ionized dome presumably reflects radio waves, and may provide an explanation for the unpredictable behavior of radio communications. It is too faint to be seen from the earth, but it can be detected with optical instruments which measure its height and locate the irregularities that upset radio transmissions.

FACED WITH SHORTAGES, leading TV manufacturers have been paring strategic materials from their sets. Both Philco and RCA have announced new chassis designs which provide a substantial saving in such critical materials as aluminum, Alnico V (which is made of cobalt, nickel, copper, and aluminum), copper, silicon steel and ferrite. The new designs, in both cases, are the product of extensive development over many months, and some of the new circuits not only save materials but actually give better performance. Production of the new sets starts during April.

An important feature is the new electrostatically focused picture tube which eliminates the need for a focusing magnet. A new voltage doubler in the Philco sets cuts the amount of transformer steel used by about 60%, and other savings are effected by using plastic in place of aluminum where possible, eliminating width and linearity coils, and using smaller wire and shorter leads.

Both Philco and RCA have put their new designs at the disposal of the industry as a contribution to the conservation program. However, many of the new features are not regarded as conservation measures alone, and will likely be permanent changes in set design even after shortages subside.

EDMUND R. MORTON, pathfinder in the development of electronic control devices and holder of more than fifty patents in electronics, died in Brooklyn, N.Y., Feb. 21, at the age of fifty-four. An engineer at the Bell Telephone Laboratories for 27 years, Mr. Morton's specialty was electronic control, but he also worked on the development of power apparatus, special purpose relays, radar, sonar and, in his early years, motors for the first television systems designed by the Bell Laboratories. He was a member of the IRE, Telephone Pioneers of America, and a number of other associations.

TECHNICAL AID for city and state schools which are interested in adding television training to their vocational programs will be offered by the Radio-Television Manufacturers Association, if a proposal before that group's board of directors is approved. The New York State school system is already actively interested in such a plan, and may offer an opportunity for establishing a pattern that could be extended all over the country. While public schools could not very well work with a single manufacturer, an RTMA spokesman pointed out that there would be no objection to assistance from a committee representing the entire industry.

Six Months from Today Which will YOU hold?

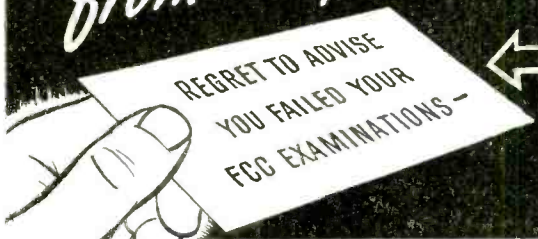

THIS
OR THIS



ADD TECHNICAL TRAINING TO YOUR PRACTICAL EXPERIENCE

GET YOUR FCC LICENSE IN A HURRY!

THEN—Use Our Amazingly Effective JOB-FINDING Service

Get this Valuable Booklet **FREE**



TELLS HOW —

WE GUARANTEE TO TRAIN AND COACH YOU AT HOME IN SPARE TIME UNTIL YOU GET YOUR FCC LICENSE

If you have had any practical experience—Amateur, Army, Navy, Radio repair, or experimenting.

TELLS HOW —

Employers make JOB OFFERS Like These to Our Graduates Every Month

Telegram, August 9, 1950, from Chief Engineer, Broadcast Station, Pennsylvania, "Have job opening for one transmitter operator to start immediately, contact me at once."

Letter, August 12, 1950, from Dir. Radio Div. State Highway Patrol, "We have two vacancies in our radio Communication division. Starting pay \$200; \$250 after six months' satisfactory service. Will you recommend graduates of your school. These are just a few examples of the job offers that come to our office periodically. Some licensed radiomen filled each of these jobs . . . it might have been you!"

HERE'S PROOF FCC LICENSES ARE OFTEN SECURED IN A FEW HOURS OF STUDY With OUR Coaching AT HOME in Spare Time.

Name and Address	License	Lessons
Lee Worthy, 2210 1/2 Wilshire St., Bakersfield, Cal.	2nd Phone	16
Clinford E. Vogt, Box 1016, Dania, Fla.	1st Phone	20
Francis X. Foerch, 38 Baucier Pl., Bergenfield, N. J.	1st Phone	38
S/Sgt. Ben H. Davis, 317 North Roosevelt, Lebanon, Ill.	1st Phone	28
Albert Schoell, 110 West 11th St., Escondido, Cal.	2nd Phone	23

CLEVELAND INSTITUTE OF RADIO ELECTRONICS
Desk RE-28, 4900 Euclid Bldg., Cleveland 3, Ohio
Approved for Veteran Training Under G. I. Bill

TELLS HOW —

Our Amazingly Effective JOB FINDING SERVICE Helps CIRE Students Get Better Jobs

Here are a few recent examples of Job-Finding results:

GETS FIVE JOB-OFFERS FROM BROADCAST STATIONS
"Your Chief Engineer's Bulletin, is a grand way of obtaining employment for our graduates who have obtained their 1st class license. Since my name has been on the list I have received calls or letters from five stations in the southern states, and am now employed as Transmitting Engineer at WMMT."
Elmer Powell, Box 274, Sparta, Tenn.

GETS CIVIL SERVICE JOB
"I have obtained at position at Wright-Patterson Air Force Base, Dayton, Ohio as Junior Electronic Equipment Repairman. The Employment Application you prepared for me had a lot to do with my landing this desirable position."
Charles E. Loomis, 4516 Genessee Ave., Dayton 6, Ohio.

GETS JOB WITH CAA
"I have had half a dozen or so offers since I mailed some fifty of the two hundred employment applications your school forwarded me. I accepted a position with the Civil Aeronautics Administration as Maintenance Technician. Thank you very much for the fine cooperation and help your organization has given me in finding a job in the radio field."
Dale E. Young, 122 Robbins St., Owosso, Mich.

OURS IS THE ONLY HOME STUDY COURSE WHICH SUPPLIES FCC-TYPE EXAMINATIONS WITH ALL LESSONS AND FINAL TESTS.

Your FCC Ticket is always recognized in all radio fields as proof of your technical ability.



Get All 3 FREE

MAIL COUPON NOW

CLEVELAND INSTITUTE OF RADIO ELECTRONICS
Desk RE-28—4900 Euclid Bldg., Cleveland 3, Ohio
(Address to Desk No. to avoid delay)

Approved For Veteran Training Under G. I. Bill
I want to know how I can get my FCC ticket in a minimum of time. Send me your FREE booklet, "How to Pass FCC License Examinations" (does not cover exams for Amateur License), as well as a sample FCC-type exam and the valuable new booklet, "Money-Making FCC License Information."

NAME.....
ADDRESS.....
CITY.....ZONE.....STATE.....
Paste on penny post card or send air mail.

Watch
MERIT
for TV in '51

Merit is meeting the rapidly rising demand for TV replacements with a TV line as complete as current and advance information will permit

TRY MERIT FIRST FOR TV CONVERSION OR REPLACEMENT!



HV06—Universal Ferrite core "FLYBACK" permits widest coverage.



MDF70—70° high efficiency Ferrite yoke for tubes up to 19"

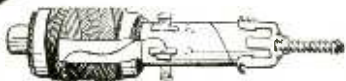

MWC-1—Width linearity control with AGC winding (Automatic Gain Control).

FOCUS COILS



Free!

Write today for:

- MERIT TV REPL GUIDE AND CATALOG**
—Dec. 1950 issue. Up-to-date listing of all replacements.
- MERIT 1951 CATALOG No. 5111**
Show specs. on complete line of TV, Radio, Amateur and Industrial Transformers.

REFER TO MERIT'S LISTING IN HOWARD SAM'S PHOTOFACTS

TAPE-MARKED TO HELP YOU!
Handy tape marking on every Merit Transformer shows permanent hook-up data for quick reference. ORIGINAL BY MERIT.

MERIT
TRANSFORMER CORP.

4443 NORTH CLARK ST., CHICAGO 40, ILL.

HIGH-EMISSION CATHODES with high reliability and great mechanical strength were recently described by George Esperson of the Philips Laboratories, Irvington, N. Y. In its simplest form, the cathode consists of two chambers shaped from one piece of molybdenum. The lower chamber, open at one end, contains an insulated filament for indirect heating. A cap of porous tungsten closes the upper chamber which contains a tablet of barium-strontium carbonate. It has a flat circular emitting surface that makes it suitable for klystrons, disc-seal diodes and triodes, cathode-ray tubes, and iconoscopes.

The new cathode has a much greater life and emission than oxide-coated cathodes, it is not affected by electrostatic forces encountered in high-voltage operation, and it easily recovers from oxygen and other gas poisoning and from bombardment by high-velocity gas ions.

SUPERCONDUCTIVITY, or the virtual disappearance of electrical resistance, has been found to occur in osmium and ruthenium in their purest forms when they are subjected to the extremely cold temperature of less than a degree above absolute zero. These two elements are in the region between uranium and rhenium, also superconductors, in the chemical periodic table. This recent discovery was made at the Royal Society Mond Laboratory in Cambridge, England, where a number of other elements were found to be not superconducting at temperatures within a few tenths of a degree of absolute zero.

MADDIDA, short for "magnetic drum digital differential analyzer," is the name of a new desk-sized computer designed at the Stevens Institute of Technology in Hoboken, N. J. The machine has less than 100 tubes and only one moving part—a rotating memory drum that can store as many as 10,000 digits and locate any one of them in about three ten-thousandths of a second. Maddida will be especially useful for industrial problems such as predicting the best design for a ship or airplane, calculating production line figures, or solving quality control or continuous flow problems. The first models will be used for working out some of the Navy Department's research problems. In the future Maddida will be built on a production basis and will be made available to industrial and business establishments.

TRAIN PERFORMANCE will be calculated by a new mechanical brain developed for the Pennsylvania Railroad Company. Consisting of three self-balancing potentiometer-type, curve-drawing instruments electrically interconnected and a low-energy auxiliary circuit, the device computes and records the economics, application, proper size and tonnage ratings for new types of motive power. This information was previously found by tedious mathematical calculations.

TV BROADCASTERS' GROUP began its organization in Chicago recently with the election of nine board members and a temporary chairman. Four more board members are to be named by the TV networks. Organized within the structure of the National Association of Broadcasters, the new group will be essentially autonomous and will probably bear the name NAB-TV. At present the board of the organization is submitting organizational plans to members for approval and suggestions, and a formal organizational meeting is expected to be held during the NAB's April convention in Chicago, but independently of that group. The present Television Broadcasters Association is taking an active part in the organization of the new group and will probably be absorbed in it when plans are completed.

TV SERVICING PROBLEMS in New York City, while still far from being ended, have just recently shown some definite signs of improvement according to *Retailing Daily*. Martin L. Scher, sales manager of Motorola-New York, Inc., and chairman of a distributors' committee that was set up to help stabilize the servicing industry, expressed the opinion that the signs of improvement are a result of the trade's growing awareness of the seriousness of the problem. Open discussion by various elements in the trade of what is wrong with TV servicing and what is needed to improve it have been very helpful.

One trend is for dealers who have maintained stopgap service departments to hand over their servicing to distributors, and two major distributors besides RCA Victor now maintain large-scale service establishments in New York. The fact that wholesalers may have no sets to sell six months from now, while servicing will continue to expand is one reason why many are considering entering the servicing field.

While the supply of replacement parts is still tight, the flow has increased somewhat recently. The supply of wire, for example, has increased to the point where the wholesale price has dropped sharply. However, many service establishments and dealers are still using shortages as an alibi for poor service.

SERVICE LICENSE BILL that would require a \$2 license fee and a \$2,000 bond from firms selling service contracts for television sets, radios or household appliances has been introduced to the Rhode Island General Assembly by Rep. Alfred P. Perrotti. Licenses would be granted by a department of business practices that would have the power to establish rules and regulations for the fulfillment of service contracts.

ELECTRONIC DISTRIBUTORS in Philadelphia are turning to defense contracts as a means of keeping their organizations intact in the face of consumer goods cutbacks. Four major agencies have already taken on defense work and others are expected to follow suit.

— END —

ADVERTISED IN

LIFE

...news of famous products

FOR

Studio-Matched

PICTURES



9 out of 10 Leading Set Manufacturers use

HYTRON Studio-Matched PICTURE TUBES



HYTRON

a subsidiary of

RECTOR ELECTRONIC CORP.

NEW YORK, N.Y.

26,000,000

POTENTIAL CUSTOMERS

How many will you sell!

LIFE for March 12, starts the ball rolling: 26,000,000 readers.

This timely full-page ad. An ideal sales package — original Hytron *studio-matched* rectangular tubes. The choice of 9 out of 10 leading TV set makers. All backed by this *free*, sure-fire “Advertised in LIFE” display card for *your* window and *your* counter. Play safe.

Call your Hytron jobber *today*. Make sure you don’t miss this tie-in display card. Get your share of those 26,000,000 potential customers!

MANUFACTURERS OF RECEIVING TUBES SINCE 1921

HYTRON

RADIO AND ELECTRONICS CORP.



MAIN OFFICE: SALEM, MASSACHUSETTS

NEW 5th EDITION
Hytron Reference Guide
for Miniature Electron Tubes

FREE from your Hytron jobber. Miniature types are still multiplying fast. You need this new Hytron Reference Guide. Originated by Hytron, it is unique . . . complete. Lists all miniatures to date, regardless of make. Six pages of pertinent data. 165 miniatures — 33 of them new. 81 basing diagrams. Lists similar larger prototypes. Get your free copy of this old friend brought up to date—today from your Hytron jobber.



USE PHOTOFAC

the world's best Radio-TV service data—it pays for itself every working day

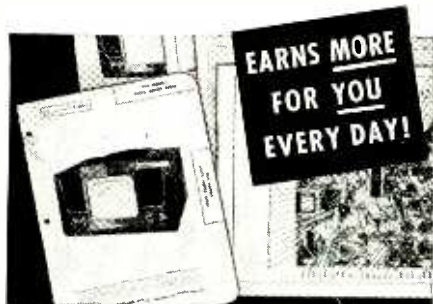

Try **PHOTOFAC!**

FREE We'll send you any Photofact Folder listed in the Photofact Cumulative Index

WE'LL PROVE YOU'LL SAVE TIME and EARN MORE WITH PHOTOFAC

NOW—learn for yourself—at our expense—how **PHOTOFAC** makes your Radio and TV work *quicker, easier, more profitable!* Examine an actual **PHOTOFAC** Folder. Use it. You'll learn first-hand why over 35,000 successful service technicians use **PHOTOFAC** daily. You'll learn that no other service gives you **PHOTOFAC'S** completeness, accuracy, uniformity, and lowest cost. **PHOTOFAC** is the *only* radio and TV service data prepared from laboratory analysis of the actual equipment. Know the facts—get your **FREE** Folder now. Examine, use, compare—learn why no modern service shop can afford to be without **PHOTOFAC!**

WRITE FOR FREE INDEX

PAY AS YOU EARN! Ask your distributor about this amazing plan. Only \$18.39 puts the entire profit-boosting Photofact library in your shop now!

NOTE: Our **FREE** Folder offer is limited to Service Technicians only. Attach coupon below to your letterhead and mention your jobber's name. If you have no letterhead, send coupon to your jobber. Experimenters and others may obtain the Photofact Folder by remitting amount shown below.

HOWARD W. SAMS & CO., INC.
2201 E. 46th St., Indianapolis 5, Ind.

- Send **FREE** Photofact Cumulative Index
 Send Full Easy-Pay Details

I am a Service Technician:

- Send **FREE** Folder for set model.....

I am an Experimenter: Enclosed \$.....

- Send Folder for set model.....
TV-\$1.00. Record Changer or Comm. Receiver-75c. AM/YM-50c

Name.....

Address.....

City.....Zone...State.....

Merchandising and Promotion

Sylvania Electric Products is sponsoring an extensive advertising and merchandising campaign promoting radio and television servicing. Terry P. Cunningham, director of advertising for Sylvania announced that the campaign will coordinate a weekly TV program,



national advertising and comprehensive point-of-sale material. The point-of-sale kit for authorized distributors of Sylvania tubes will include colorful window displays featuring prominent movie stars, counter cards and streamers available upon request without charge. Postal cards for direct mail are also available.

Raytheon Manufacturing Co. has launched a consumer advertising campaign through co-operating Raytheon tube distributors supporting its "Bonded Electronic Technician Program". Almo Radio Co., Philadelphia; Metropolitan Radio-Electronics Corp., New York City; Trojan Radio Co., Troy, N. Y.; Mattson's Inc., Richmond, Va.; Hi-Park Distributors, Detroit; McGee Radio & Electric Co., Kansas City, Mo.; A. T. Stewart Co., Tacoma, Wash.; and The Henderson Co., Los Angeles are among the jobbers sponsoring the program.

M. A. Miller Manufacturing Co., Chicago manufacturer of phonograph needles, recently introduced a replacement needle cross-reference guide. The guide includes the number of the replacement needle, the name and number of the manufacturer, tip material, radius and list price. The chart also includes needles of competitive firms. It is available free from the Miller Co.

Jensen Manufacturing Co. of Chicago is promoting its G-610 triaxial speaker with a campaign tying in an endorsement by Dick Jergens, band leader and ex-Marine Corps radio operator.

Servicing Business

The Simpson Electric Company of Chicago is giving a series of illustrated lectures to service technicians to promote its TV testing equipment. Jack Whiteside, chief electronic engineer, gives the slide lectures which are sponsored by key distributors throughout the country.

Allen B. Du Mont Laboratories, Inc. Teleset Service Control Department is sponsoring a series of nationwide service meetings. E. W. Merriam, manager

of the Teleset Service Department, also revealed that the department would begin publication of a monthly, *Du Mont Service News* for all service personnel. The publication will include the latest data on installation and service problems on Du Mont receivers.

RCA Tube Department TV specialist John R. Meagher has recently conducted a series of TV service clinics in the South. He used the RCA TV dynamic demonstrator, a complete TV receiver laid out on an upright panel to expose all the parts. Mr. Meagher demonstrated various techniques and shortcuts in TV servicing. The clinics in Atlanta, Ga., Charlotte, N. C., and Birmingham, Ala., were sponsored by authorized RCA distributors.



Production and Sales

The NBC TV Sales Planning and Research Department announced that there were 10,549,500 TV sets in the U. S. as of January 1, 1951. About 6,600,000 of these were installed during 1950. According to these figures every fourth family in the U. S. now owns a TV set. New York leads with 2,050,000 TV families, followed by Chicago with 830,000, Philadelphia, 750,000; Boston, 642,000; Detroit, 405,000; and Cleveland, 396,000.

The RTMA reported that sales of TV picture tubes to receiver manufacturers during 1950 totalled 7,473,614, valued at \$189,737,428. This compares with 3,305,673 tubes valued at \$92,402,520 in 1949. About 72% of the tubes were 16-inch or larger, while in 1949 only 16% were 14-inch or larger.

RTMA announced that 7,068,000 TV receivers were sold to dealers in 36 states and the District of Columbia during 1950. This more than doubled the 1949 shipments. The estimate includes members and non-members of the association. However, production of both TV and radio receivers dropped below the averages of the last quarter of 1950 during January, 1951. Radio production was off 9% and TV production 21%.

The RTMA also announced that 383,960,599 radio receiving tubes were sold during 1950, an increase of 93% over 1949 sales of 198,753,295.

New Plants and Expansions

Electro-Connector Manufacturing Corp., producer of electronic and TV

components, has completed its new plant in Philadelphia. The company also has added a special products division to develop and manufacture products for the aircraft and electronic industries and a division to manufacture a new type of connector.

General Electric Co. has begun construction on a new four-story addition to its tube manufacturing plant in Owensboro, Ky. The new structure, with a floor space of 117,000 square feet will cost approximately \$2,000,000. It will be ready by July 15. G-E also announced plans to construct a new multi-million dollar electronics equipment manufacturing plant near Utica, N. Y.

Raytheon Manufacturing Company's new pilot tube plant in Quincy, Mass., is now in operation. The new plant is operated by the Receiving Tube Division and manufactures electronic tubes for military use. The company expects that sometime in the future the plant will be used to augment regular production capacity. Raytheon also made known plans for a new \$2,000,000 plant in Waltham, Mass., for tube production for the armed forces.

Channel Master Corp. has completed construction on the new 25,000-square-foot addition to its antenna plant.

Tel-O-Tube Corporation of America, Passaic, N. J., has installed two new production lines to increase production of cathode-ray tubes.

Wells Sales, Inc., is now doing business from its new location at 833 West Chicago Avenue, Chicago, following the destruction of one of its warehouses by the sensational Chicago fire early this year. The firm announced that the greater portion of its inventory had been stored in three other warehouses.

Condenser Products Company is moving to new and larger quarters on North Clark Street, Chicago, following the destruction of their factory by fire.

Sheldon Electric Company, a subsidiary of Allied Electric Products, Inc., is rushing construction of a new two-story addition to its new building in Irvington, N. J.

Radio Materials Corp. opened its second plant in Attica, Indiana. The company also has a plant in Chicago which manufactures ceramic capacitors.

Cleveland Institute of Radio-Electronics is now occupying new and larger quarters in the Radio Cleveland Building, Euclid Avenue.

Financial Reports

General Instrument Corp.			
(9 months to Nov. 30, 1950)			
	1950	1949	
Earnings...	\$769,247	(loss)	\$62,652
	1950	1949	
Sales	\$18,509,489		\$9,017,196

Raytheon Manufacturing Co.			
(6 months to Nov. 30, 1950)			
Earnings ..	\$1,278,000	(loss)	\$622,000
Sales	\$41,000,000		\$22,988,129

Hytron Radio & Electronics Corp.			
Preliminary Annual Report			
	1950	1949	
Earnings	\$3,500,000		\$565,170
Sales	\$41,500,000		\$16,226,000

We CHALLENGE the performance of any 12" speaker with a Permoflux ROYAL EIGHT"

SAYS PERMOFLUX'S MR. HY-FY

This averaged laboratory response curve of the Permoflux 8T-8-1 proves that it compares with the finest speakers regardless of size or price.

Hi-Fi Fans the country over have accepted this challenge—have asked their "soundman" for a demonstration—then, have installed a Permoflux Royal Eight" in their own audio equipment. Now they possess a magnificent speaker at a reasonable price which reproduces sound with superior sensitivity and fidelity as well as tonal qualities which YOU too will want to add to perfect the excellence of your own equipment.

Send for beautifully illustrated catalog No. J201 to address listed below for further information including a full page devoted to correct baffling of Royal Eight" and other size speakers.

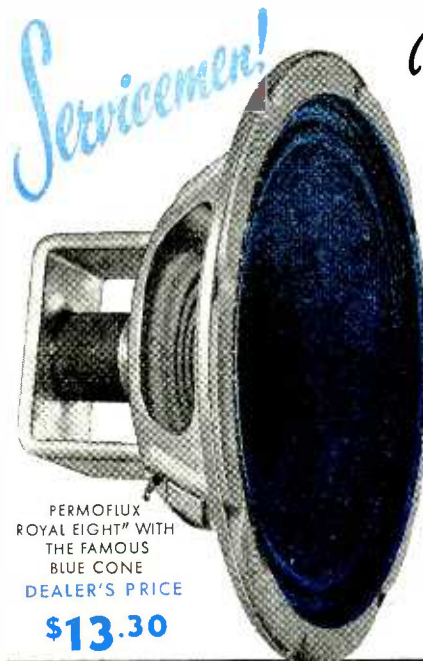

PERMOFLUX ROYAL EIGHT" WITH THE FAMOUS BLUE CONE
DEALER'S PRICE
\$13.30

Check These Exclusive Features

Permoflux's exclusive slotted, treated cone gives the following results which makes their speaker comparable to any 12" speaker:

- Soft-suspended cone and extra-large spider provide extended low frequency response.
- Deeper, curvilinear cone greatly extends high-frequency response.
- High permeance yoke increases output.
- 8 ohm—10 watt voice coil.
- Big speaker performance in a small frame allows smaller more economical baffle.

Here's EIG SPEAKER performance—clean, brilliant, musical reproduction but at a sensible price level. Your customers will approve and buy. Order one for test today—your money refunded if you do not agree that it is truly outstanding in performance.

Inquire about Permoflux's Complete Royal Blue Line 6" to 15" Speakers

10-DAY TRIAL—MONEY BACK GUARANTEE

	PERMOFLUX CORPORATION 4910 W. Grand Ave., Chicago 39, Ill.	
	<input type="checkbox"/> Please send _____ Permoflux Royal Eight" (8T-8-1) <input type="checkbox"/> Check <input type="checkbox"/> Money order enclosed	
Name of Favorite Distributor		
Your Name		
Address		
City		Zone State

SPEED YOUR SERVICE!



Your choice of two new Blue-Shift quickest-for-servicing Control Kits

These two new kit assortments of Centralab new Blue Shaft controls, contain 22 fast-moving modern service items — including factory attached switches . . . ready for you to install — complete in metal cabinets.

KIT DEAL B-A — 22 CONTROLS

½ Meg and 1 Meg

All C2 (audio) taper. The B types have standard 3" shafts, full length fluted mill. The BSK types have 2½ split knurl shafts.

PLAIN TYPE		SWITCH TYPE	
3 B-60	½ meg	5 B-60-S	½ meg
2 B-70	1 meg	3 B-70-S	1 meg
2 BSK-60	½ meg	3 BSK-60-S	½ meg
2 BSK-70	1 meg	2 BSK-70-S	1 meg
1 Metal Cabinet			

LIST PRICE \$29.40

KIT DEAL B-B — 22 ASST. CONTROLS

All have standard 3" shafts, full length fluted mill.

PLAIN TYPE

1 B-31	50,000 ohms	C1
1 B-40	100,000 ohms	C1
1 B-51	250,000 ohms	C2
1 B-59	½ meg	C1
1 B-60	½ meg	C2
1 BT-67	½ meg	C13 tapped
1 B-70	1 meg	C2
1 BT-73	1 meg	C13 tapped
1 B-76	2 meg	C2
1 BT-80	2 meg	C13 tapped
1 Metal Cabinet		

SWITCH TYPE

1 B-31-S	50,000 ohms	C1
1 B-40-S	100,000 ohms	C1
1 B-51-S	250,000 ohms	C2
1 B-59-S	½ meg	C1
2 B-60-S	½ meg	C2
1 BT-67-S	½ meg	C13 tapped
2 B-70-S	1 meg	C2
1 BT-73-S	1 meg	C13 tapped
1 B-76-S	2 meg	C2
1 BT-80-S	2 meg	C13 tapped

LIST PRICE \$35.60

RADIO-ELECTRONICS for

USE CENTRALAB KITS

All Centralab Kit Parts are selected according to modern TV and Radio requirements . . . All Fast Moving Stock No "Sleepers"

The kits you see here are stocked by leading parts distributors everywhere. Each kit has been carefully selected so that each item can currently be used in modern radio or TV sets. Kits are packed in handy metal or plastic containers — later useful for many purposes.



Plasti-paks contain your choice of eight different assortments of 12 controls each.



Adashaft kits contain basic controls, shafts and switches. You add the exact shaft needed.



Rotary switch kit contains parts and hardware to make your own switch assemblies.



Model 414 switch kit. Extra large assortment of rotary switch parts. Much in demand by labs.



Ceramic capacitor kit DW 200. Has 200 items. Values from 10 to 10,000 mmf.

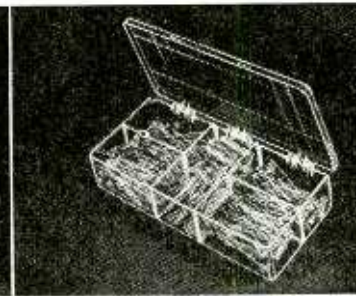

Kit DK-100 contains 100 ceramic capacitors (20 of each of 5 values.)

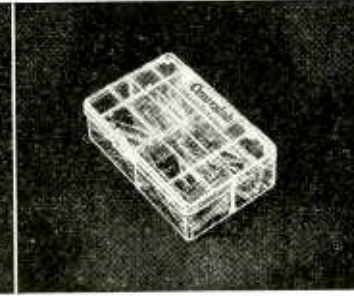

Plasti-Pak No. 40 contains 40 different ceramic tubulars — 4 different values.



Kit DK-25 or kit DDK-25. Your choice of 25 ceramic tubulars or 25 disc Hi-Kaps.

Centralab
ERL
 Division of **GLOBE-UNION INC.** Milwaukee, Wis.

CENTRALAB Division of Globe-Union, Inc.
 922 East Keefe Avenue, Milwaukee 1, Wisconsin
 Please send me complete details on Centralab kits.
 Also include new Centralab Catalog No. 27.

Name.....
 Address.....
 City..... Zone(.....) State.....

PLEASE! I am a Service Engineer Ham Jobber TV Set Owner

Westinghouse Electric Corporation declared a quarterly dividend of 50¢ on common stock which was paid on March 5.

Business Briefs

... The RTMA has completed a reclassification of electronic component parts at the request of the Munitions Board. The new grouping will permit ready identification of parts by the establishment of eleven major classifications into which all components must fall. The new classifications are: transducers, transducer accessories, antennas, circuit interrupters, resistors, capacitors, transformers, housings, piezo-

electric frequency control devices, plugs and connectors, and hardware.

... National Union, Sheldon Electric and RCA have announced the production of electrostatic focusing TV picture tubes which require no focus coils, saving scarce cobalt and copper. Sylvania is reported working on the development of similar tubes.

... The Leotone Radio Company, New York City, has a new department for reshaping Alnico magnets for experimental purposes.

... Duotone Company, Keyport, N. J., has introduced a new diamond phonograph needle for most standard tone arm models.

... Fidelity Tube Corp. plans to manufacture miniature receiving tubes. The company had been manufacturing cathode-ray tubes exclusively.

... Electro-Connector Manufacturing Corp. announces formation of the ELCO Corporation to handle its sales.

... The RTMA held an Industrial Relations Conference at which all phases of the electronics industry's manpower problems in the present period of mobilization were discussed.

... The National Production Authority has formed a task group, consisting of distributors in the radio, TV, and appliance industries, to help stabilize maintenance and repair of radio, TV, and appliances in the face of growing shortages.

... Radar-Radio Industries of Chicago, Inc., has been reactivated, according to the statement of Leslie F. Muter, president of the Muter Co. The RRIC, a nonprofit organization, was originally established during World War II to aid Chicago radio manufacturers with their production problems.

... Insuline Corporation of America, Long Island City, N.Y., is producing a set of phonograph records for teaching International Morse code.

... The Joint Electron Tube Engineering Council has established a special task committee on critical materials used in the manufacture of radio-TV tubes. A. C. Gable, of General Electric Company, is chairman, and R. R. Batcher, RTMA chief engineer, is secretary.

... The Association of Electronic Parts and Equipment Manufacturers and the Sales Managers Club, Eastern Group, have submitted a plan to the Electronic Products Division of the NPA that would make it easier for manufacturers to buy raw materials for making supplies to keep existing electronic equipment in good order. The nine-point plan recommends that distributors be limited to a 180-day inventory and sell maintenance, repair, and operating supplies only to customers who certify in writing that the material will be used for repair.

... Ward Leonard Electric Co. has announced that it expects to be unable to ship future orders unless they have a DO (defense order) rating.

... Coyne Electrical & Television-Radio School, Chicago, has announced jointly with Howard W. Sams & Co., that the Sams organization would distribute Coyne electronic and electrical publications under an exclusive franchise to the electronic parts suppliers.

... Cadillac Electronics Corp., New York City, is a new TV set manufacturing firm established by I. R. Ross.

... RCA Victor has established a new employment division geared to develop manpower sources to meet the company's requirements for experienced engineering personnel. Robert E. McQuiston was named manager of the new Specialized Employment Division. ... Tel-a-Ray Enterprises, Inc., Henderson, Ky., announced an allocation system for distributors of its TV antennas and allied products.

—END—

RADIO-ELECTRONICS for



Dependability

is the word for

CORNELL-DUBILIER
VIBRATORS

CORNELL-DUBILIER... the name that stands for quality — assures you of the finest in vibrators. A type for every replacement need... engineered for dependable peak performance under even the most adverse conditions. And they are QUIETER... affording the maximum... yet at no extra cost.

CONSISTENTLY DEPENDABLE
CORNELL-DUBILIER
SOUTH PLAINFIELD, NEW JERSEY





• CAPACITORS • ANTENNAS
• ROTATORS • VIBRATORS • CONVERTERS

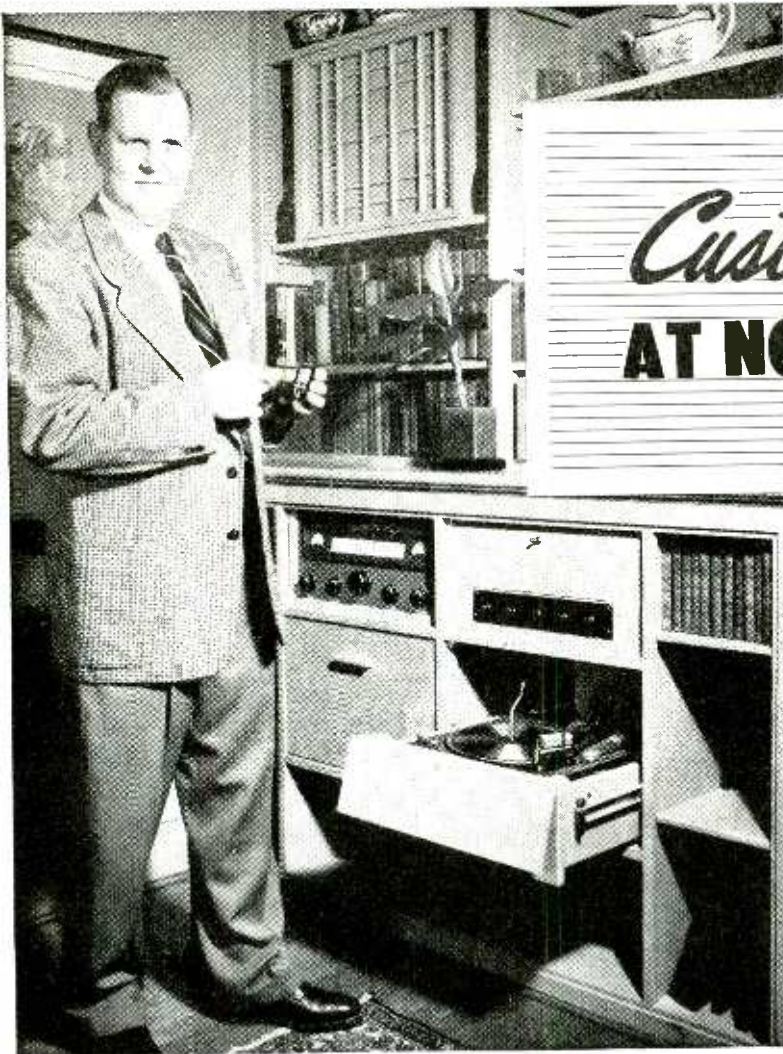

Custom Quality
AT NO EXTRA COST!



**VARIABLE
 RELUCTANCE
 CARTRIDGES**

WHERE cost is no problem, custom designers specify the best. Philip C. Kelsey of Guilford, Connecticut, shows here beside one of his made-to-order FM phonograph installations, says:

"Customer satisfaction means everything in my business. That's why G-E cartridges are standard in all my installations. I know they are the best."

This same cartridge—with diamond or sapphire tip—belongs in your line and in your customers' sets. More than 100,000 G-E cartridges were sold last year—a better score than all other VR cartridges combined! Today, more than ever before, dealers will push quality merchandise backed by a name people believe in—General Electric.



**Build Your Profits...
 Build Your Reputation**

Stock the complete G-E Parts Line now—let your customers know you can put new life into radios, phonographs, TV sets, with General Electric

- Speakers
- Styli
- Tone Arms

Call your G-E distributor today, or write: *General Electric Co., Electronics Park, Syracuse, N. Y.*

JUST OUT!

—GET YOUR COPY NOW!

General Electric Company
 Section 4341
 Electronics Park, Syracuse, N. Y.

Send me your new stylus booklet "Why You Should Use a Diamond."



NAME _____
 ADDRESS _____
 CITY _____ STATE _____

GENERAL  ELECTRIC

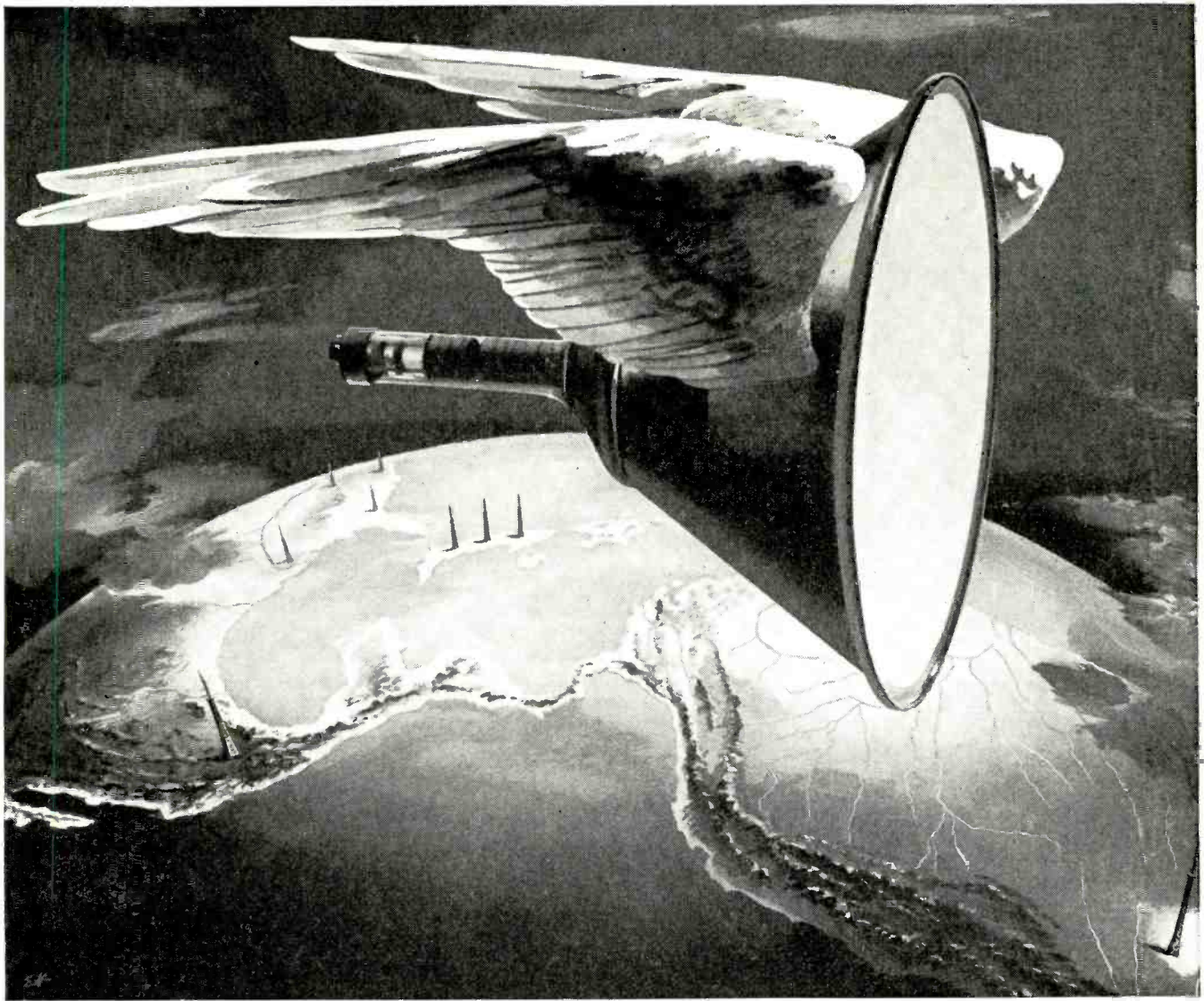

Five new RCA-equipped stations in Mexico, Brazil, and Cuba, add television to the forces which make Good Neighbors of all the Americas.

Now television goes "Good Neighbor"

As little as 10 short years ago, television—to the average man on the street—seemed far away. Today, television is in 10,500,000 homes.

Newest demonstration of TV's growth is its leap to Latin America. Three RCA-equipped stations are now in Cuba, one in Mexico, another in Brazil—and more are planned. They are contributing to television progress by following a single telecasting standard. They also use developments from RCA Laboratories: the image orthicon tel-

evision camera, electron tubes, monitoring equipment, and antennas.

And as our neighbors to the south watch television at home, they see another development of RCA research—the kinescope. It is the face of this tube which acts as the "screen" in all-electronic home TV receivers . . . on which one sees sharp, clear pictures in motion.

See the latest wonders of radio, television, and electronics at RCA Exhibition Hall, 36 West 49th St., N. Y. Admission is free. Radio Corporation of America, RCA Building, Radio City, New York 20, New York.

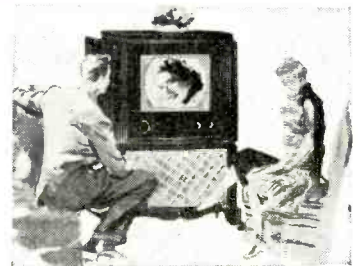

Results of RCA Research are seen in the magnificent pictures produced on the screens of the new 1951 RCA Victor home television receivers.



RADIO CORPORATION of AMERICA

World Leader in Radio — First in Television.

New SUPREME 1951 TV Manual



New 1951 Television Manual

This newest giant volume of the series covers 1951 factory data on all popular television sets of all makes. There are circuit explanations, 192 pages of alignment procedure, test patterns, response curves, pages of waveforms, voltage charts, service hints, and dozens of large double-page circuit diagrams. Manual style binding. At your parts jobber or by mail, only..... **\$3**

1950 T-V Manual. Includes service material on all popular TV sets of all makes from Admiral to Zenith. Large size: 8 1/2 x 11". plus ten mammoth 11x17" blueprints. Only..... **\$3**

1949 T-V Manual. Similar to the volume listed above. Has 192 extra-large pages, plus 9 double-spread giant blueprints. To order see coupon below, only..... **\$3**

1948 T-V Manual. Earlier volume has material on all popular T-V sets of this period. Large size: 8 1/2 x 11". Remarkable value. Including 8 fold-out blueprints, only.... **\$3**

1947 FM and T-V Manual. Covers all needed FM and television sets including popular R.C.A. 630TS. Size: 8 1/2 x 11". Data on 192 pages. Only..... **\$2**

INCLUDES ALL POPULAR SETS

The new 1951 TV manual has complete service material on every popular television set of every important manufacturer. Here is helpful, practical, factory-prepared data that will make servicing and adjustment easy for you. This new giant manual, as well as the previous volumes listed at left, has complete circuits, alignment facts, test patterns, response curves, service hints, voltage charts, waveforms, recommended changes for improvement, and many double-spread diagram blueprints. Here is your TV service material to help you become an expert, and at only \$3 and \$2 per manual.

FIND—FIX ALL T-V FAULTS

Use the new 1951 TV manual and the earlier volumes (see listing at left) to help you with all TV repairs. Cuts hour-wasting jobs to pleasant moments. Use test patterns for quick adjustment, or look up probable cause of trouble in the pages of hints after simply observing fault in video picture. No equipment needed with these tests. Or use your voltmeter and compare values with many voltage charts included. With an oscilloscope you can get waveforms similar to hundreds illustrated using test points suggested and in a flash locate what used-to-be a hard-to-find fault. Order at our risk for a 10-day trial. Use coupon at bottom of page.



All Supreme Publications Radio and TV manuals are compiled by M. N. Beitman, radio engineer, teacher, author, and serviceman.

AMAZING BARGAIN OFFER

The new 1951 TV manual is the most remarkable value offered by Supreme Publications in their 17 years of business. This giant-size television servicing manual at only \$3, or the TV manuals for previous years for only \$3 and \$2 each, are amazing bargains and defy competition. There is nothing else like them. Each manual is a virtual treatise on practical television repairs. By normal standards, each such large manual packed as it is with practical facts, hundreds of illustrations, diagrams, charts, photographs, and expensive extra-large blueprints, should sell for \$10—but as SUPREME special values they are priced at \$3 and \$2 each. Only a publisher who sold over one million TV and radio manuals can offer such bargains based on tremendous volume-sales.

YOURS TO USE ON TRIAL

Be ready to repair any TV set by having in your shop all five Television Manuals described at left. Or try the new 1951 TV manual to see what an amazing bargain you get for only \$3. Order on no-risk trial by using coupon at bottom of page.

SUPREME RADIO MANUALS

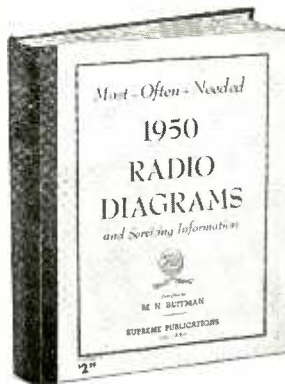

New 1950 Radio Diagrams

Now you can benefit and save money with Supreme amazing manual scoop. This one giant volume has all the service data you need on all recent radio sets. Here you have clearly-printed large schematics, needed alignment data, parts lists, voltage values, and information on stage gain, location of trimmers, and dial stringing illustrations. This is the help you need to find tough faults in a jiffy. The new 1950 radio manual is a worthy companion to the 9 previous volumes used to an advantage by over 128,000 shrewd radio men.

BIGGEST BARGAIN IN SERVICE DATA

Wise servicemen know that Supreme Publications manuals have all the material needed at the lowest prices. For the remarkable bargain price (only \$2 for most volumes) you are assured of having on hand needed diagrams and all other essential repair facts on almost all sets you will ever service. Every popular radio of all makes, from old-timers to new 1950 sets is covered. Select manuals wanted, see list below.

SUPREME RADIO MANUALS for PREVIOUS YEARS



1949 1948 1947 1946 1942 1941 1940 1939 1926-1938
SUPREME Most-Often-Needed RADIO DIAGRAMS **RADIO**
 Each Manual only \$2. (1949 is \$2.50); 192 pages of diagrams, **Diagrams**
 alignment data, voltage values, parts lists, and service **240 Pages**
 hints; large size, 8 1/2 x 11". To order, see coupon below. **Price \$2.50**

RADIO-ELECTRONICS HOME-STUDY COURSE



NEW AMAZING OFFER

Here is the most amazing bargain in radio training. The price scoop of the year. For only \$3.95 (full price) you receive a complete radio-electronics course of 53 large, fact-packed lessons. Covers every topic of radio fundamentals, practical servicing, TV, FM, audio, and industrial electronics. Published in three giant books, bound in one super-mammoth volume. Printed in 1951. Compares lesson by lesson with the best \$200 home-study correspondence courses; but here you get all lessons at one time at the unheard-of bargain price of only \$3.95; nothing further to pay or buy.

THREE COURSES IN ONE

The complete training of these 53 large lessons is really THREE distinct courses on: (1) Practical Radio, (2) Applied Electronics, and (3) Radio Servicing. The lessons are clear, practical, easy to master and use. Early lessons will make fundamentals clear even to a beginner, while other lessons will give you the practical "know-how" of an expert. Notice in the illustration of the manuals, at top, that the wide column on each page has the text, while the narrow column contains pertinent explanations usually supplied by a teacher. These teacher comments guide you over the hard parts, stress points of importance, tell you how to perform practical experiments using your home radio. There are hundreds of review self-testing questions, 427 drawings, pictures, diagrams, and over a thousand service hints.

YOURS TO TRY FOR 10 DAYS

Just send no-risk coupon, at right, and receive the 3-volume COURSE for a free examination. Use all this material a full 10 days in your own home. Read a few lessons, examine the hundreds of illustrations, apply some of the hints to fix a couple of radios. Only then, if you are pleased, the complete course of 53 lessons, in three volumes, is yours to keep for only \$3.95, full price; otherwise, it costs you nothing for the use and examination. Fair enough? Please rush coupon or ask your jobber while your special price is still only..... **\$3.95**

Supreme Publications

Sold by All Leading Radio Jobbers

NO-RISK TRIAL ORDER COUPON

SUPREME PUBLICATIONS, 3727 W. 13 St., Chicago 23, ILL.

Send on trial the manuals checked below and at right. You guarantee complete satisfaction.

<input type="checkbox"/> New 1951 Television Service Manual. . . . \$3.	<input type="checkbox"/> New 1950 Manual, \$2.50
<input type="checkbox"/> 1950 Television Manual, \$3. <input type="checkbox"/> 1949 TV, \$3.	<input type="checkbox"/> 1949 Radio Manual, \$2.50
<input type="checkbox"/> 1948 TV, \$3. <input type="checkbox"/> 1947 TV & FM, only \$2.	PRICED AT ONLY \$2 EACH 1926-1938 Manual, \$2.50
<input type="checkbox"/> Radio & Electronics Course, 53 lessons. \$3.95	
<input type="checkbox"/> I am enclosing \$..... Send postpaid.	
<input type="checkbox"/> Send C.O.D. I am enclosing \$... deposit.	
Name:	
Address:	

EICO
TEST EQUIPMENT

guards **Tele-tone**
HIGH STANDARDS OF
TELEVISION PRODUCTION QUALITY

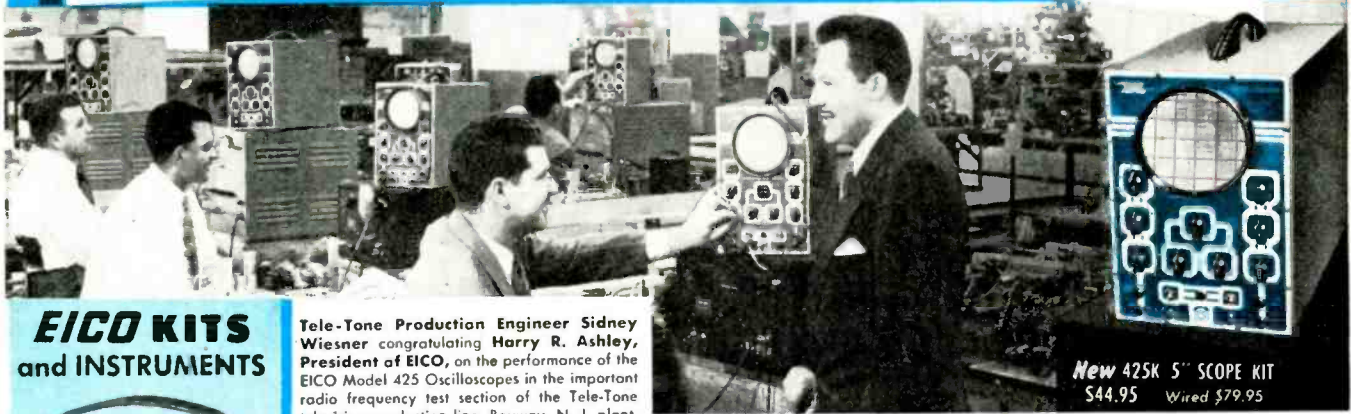

**EICO KITS
and INSTRUMENTS**

Tele-Tone Production Engineer Sidney Wiesner congratulating Harry R. Ashley, President of EICO, on the performance of the EICO Model 425 Oscilloscopes in the important radio frequency test section of the Tele-Tone television production line, Bayway, N. J. plant.

New 425K 5" SCOPE KIT
\$44.95 Wired \$79.95

For Laboratory Precision at Lowest Cost—the Leaders Look to EICO!

IN the whole world of electronics, no taskmasters enforce more stringent standards of test equipment performance than the factories making TV sets. Fiercely competitive, they daily train sharp critical eyes on their production efficiency, quality and economy. Of their test equipment they demand the highest precision, utmost speed, lowest cost and certain dependability — without compromise.

In the new giant Bayway, New Jersey television plant of the great Tele-Tone Radio Corporation — at the many vital constant-duty testing positions along the production line—EICO instruments stand guard. One of the world's foremost volume manufacturers, Tele-Tone knows that for speed, accuracy and day-after-day dependability, at maxi-

imum economy, EICO instruments always deliver the fullest measure of value.

From coast to coast, in one leading TV factory after another, this is the experience—this is the proof of EICO superiority — that is demonstrated again and again. The top-flight TV set makers have discovered — just as over 65,000 servicemen have learned — that for the industry's greatest instrument values, at the industry's lowest costs — it's EICO!

Be sure you look at the EICO line before you purchase higher-priced equipment! Each product is jam-packed with unbelievable value. YOU be the judge — compare EICO at your local jobber today—and SAVE! Write NOW for free newest Catalog 4-C.

Take nothing less than the best.
INSIST ON EICO!

EICO

ELECTRONIC INSTRUMENT CO., Inc.
276 NEWPORT STREET, BROOKLYN 12, NEW YORK

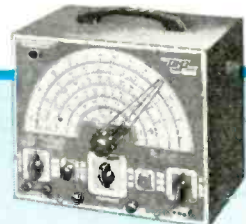

360K SWEEP GEN. KIT \$34.95
Wired \$49.95



511K VOM KIT \$14.95
Wired \$17.95

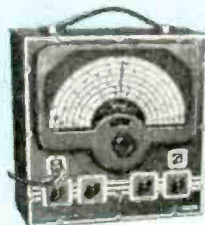

New 315K DELUXE SIG. GEN. KIT \$39.95
Wired \$59.95



New 625K TUBE TESTER KIT \$34.95
Wired \$49.95



145K SIG. TRACER KIT \$19.95
Wired \$28.95



New 221K VTVM KIT \$25.95
Wired \$49.95



320K SIG. GEN. KIT \$19.95
Wired \$29.95



New 950K COND. RES. COMP. BRIDGE KIT \$19.95
Wired \$29.95



New 1040K BATTERY E.I.M. KIT \$25.95
Wired \$34.95



HV PROBE (Wired only) \$6.95



RF PROBE KIT \$3.75
Wired \$5.95



C-5 SMC CRYSTAL \$3.95

Prices 5% higher on West Coast. Due to unsettled conditions, prices and specifications are subject to change without notice.

The Qualityed Service Technician

... How to give faster, lasting, better and more profitable service ...

By HUGO GERNSBACK

WHEN editorial writers want to make sure that you read their stuff, they pull out a "stopper," i.e., an obscure word or term which will arouse your curiosity.

We plead guilty to this hoary trick by springing the venerable, but little used, albeit philosophical, word *qualityed** on you, for reasons which will become more lucid as you proceed.

Radio and television service technicians will have realized by this time that because our national economy is once more on a war footing, shortages of all types are appearing with distressing frequency. This is true not only of various materials, but of technicians themselves, particularly the younger ones—many of whom are beginning to be drafted into the Armed Services. These conditions, already acute, will continue to get worse from month to month for a long period ahead.

This means that the older men are once more confronted with the terrific burden of keeping the country's radio and television sets functioning properly.

While it is true that this condition means more work and business for the service technicians, it often turns out to be a sad disappointment; when the year rolls by many hard workers find that while they have done a lot of business, *they have not made any money*. This happened regularly during World War II and is certain to repeat if you do not look out for the pitfall¹¹⁵.

First, the service technician should take stock and ask himself a number of questions, the chief being: How not to work one's self to a frazzle and how to get paid for the service rendered so there will be a profit in the end.

Having watched many service technicians in the past we have come to the unhappy conclusion that a large percentage of them are cursed with disorderliness. By this we mean that too many of them have little idea of working in an orderly and efficient manner. When it comes to wasting time many should be handed cardboard medals.

Look at the average service kit, which many sloppy technicians empty on the customer's floor trying to find parts or components when servicing sets. The waste of time here is really appalling. They hunt for screws, resistors, and other items by the minute, *never realizing that they have only one thing to sell—their precious time*. Unless the technician can make a large enough number of calls a day, or repair a certain number of sets, it is a foregone conclusion that he will not come out ahead at the end of the year. *He just works for nothing*.

Not long ago we watched a really first-class service technician in amazed admiration. This man—who knew the value of time—was a model of orderliness. He had

built a special service case of hardwood which opened in the center and when laid down flat on the sides, had dozens of small compartments of sturdy wood, each containing radio components. One of the sides contained the tools, which fitted exactly in their respective spaces. A metal sliding cover kept the parts in place when the case was carried. The top compartments lifted out and beneath them were various other ones holding screws, parts and components. It only took seconds to put a finger on the right item and pull it out. The technician told us that this saved him so much time that it enabled him to make extra calls without rushing all day. In the evening unflinchingly he went over his case and replenished items that had been required during the day. He used the same case when servicing a set at the bench.

All this makes for qualityed service, as should be obvious. This man also told us that he used only *quality* radio components, rarely surplus ones which he often found more expensive in the end.

This particular service technician insisted that quality came invariably first with him, and as he put it, "if there is anything that makes me hopping mad, it is to come back to the same job again to find that the capacitor which I had replaced shorted again. If I had used a good-quality capacitor in the first place, it probably would not have happened."

It is not good business to see the same customer too often in a short time because sooner or later he puts the blame on the service technician where it usually belongs.

What is true of parts and components is even more true of the radio man's tools, his analyzer, his meters, and all his other testing equipment. *During our present emergency only first-class quality material will pay out. It pays big dividends to the radio technician in the end.*

At best, from now on the service technician will be continuously harassed and *his time will become more precious as long as the emergency lasts*.

It should not be thought that this article is an indictment of surplus parts, especially since in many cases they will have to be used simply because nothing better may be available at the time.

However, when such parts are used there is a simple step to make sure that you will not come to grief. That is: do not rely upon ANY part. Do not blindly put them in a receiver. **TEST EACH PART FIRST**. Be sure that your resistor has the right ohmage, test each capacitor to make sure it is perfect. Someone in the shop can do this routinely and thus eliminate defective components. This in the end will pay big dividends. The technician will then be in a position to give *qualityed service* at all times and he will not have headaches and extra work for which HE must pay in the end.

*QUALITIED (rhymes with Sally Reed); Furnished with qualities; endowed with a quality or qualities. Webster's New International Dictionary.

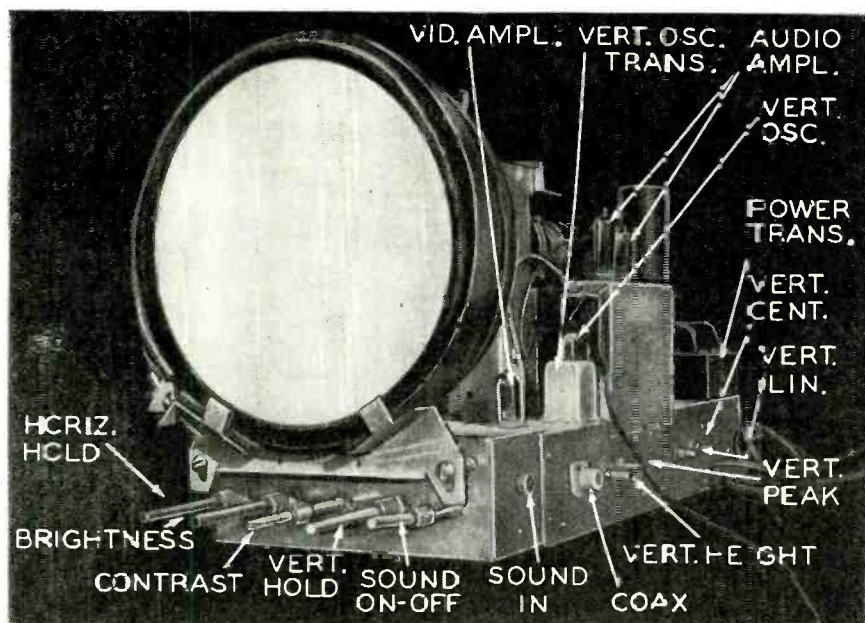

View of the slave chassis. It has a complete set of sound and picture controls.

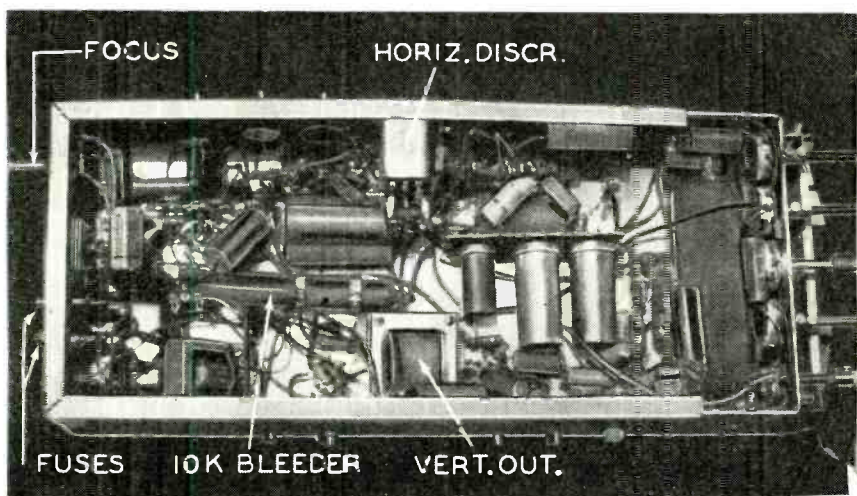

Bottom view. A somewhat larger chassis will help make the construction easier.

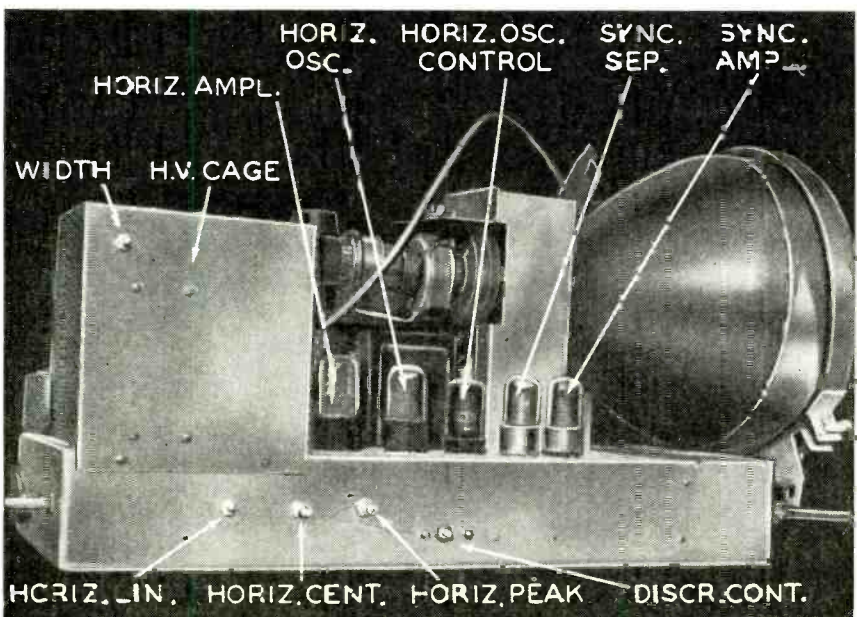

This side view shows the arrangement of the horizontal sweep and sync circuits.

Video Slave for Remote Televiwing

*Enjoy TV any place
in the house with
this full-control,
12-inch repeater*

By JOHN SHEWBROOKS

BEING the father of three young and rabid TV fans, I had to build this slave receiver out of self defense. Now we can put the slave in the children's bedroom—or any place else within reach of its 40-foot cable—and talk to our company in the evenings without competition from Hoppy's six-shooters.

The slave consists of two units. One is a small 2-tube video amplifier with cathode follower output which is mounted on the chassis of the original receiver, in our case an Admiral 30A1. Of course, the slave can be used just as well with any other good receiver. The small amplifier is built into a 2 x 3-inch chassis which fits just below the antenna terminals on the receiver. Plate and filament voltages are taken from the set, and the grid input comes from the cathode pin of the 6K6 video output. A coax cable connector connects the video line, which is a length of 72-ohm coaxial cable.

The other part of the slave contains the picture tube, an additional video amplifier stage, high-voltage supply, focus and deflection circuits, and audio amplifier. In short, it is a TV receiver minus the r.f. and i.f. sections. This allows complete picture and sound control at the slave station. The audio connects through a length of microphone cable to the high side of the volume control in the set.

The circuit (Fig. 1) is self-explanatory to anyone familiar with the workings of television. All the components are readily obtainable and are used in

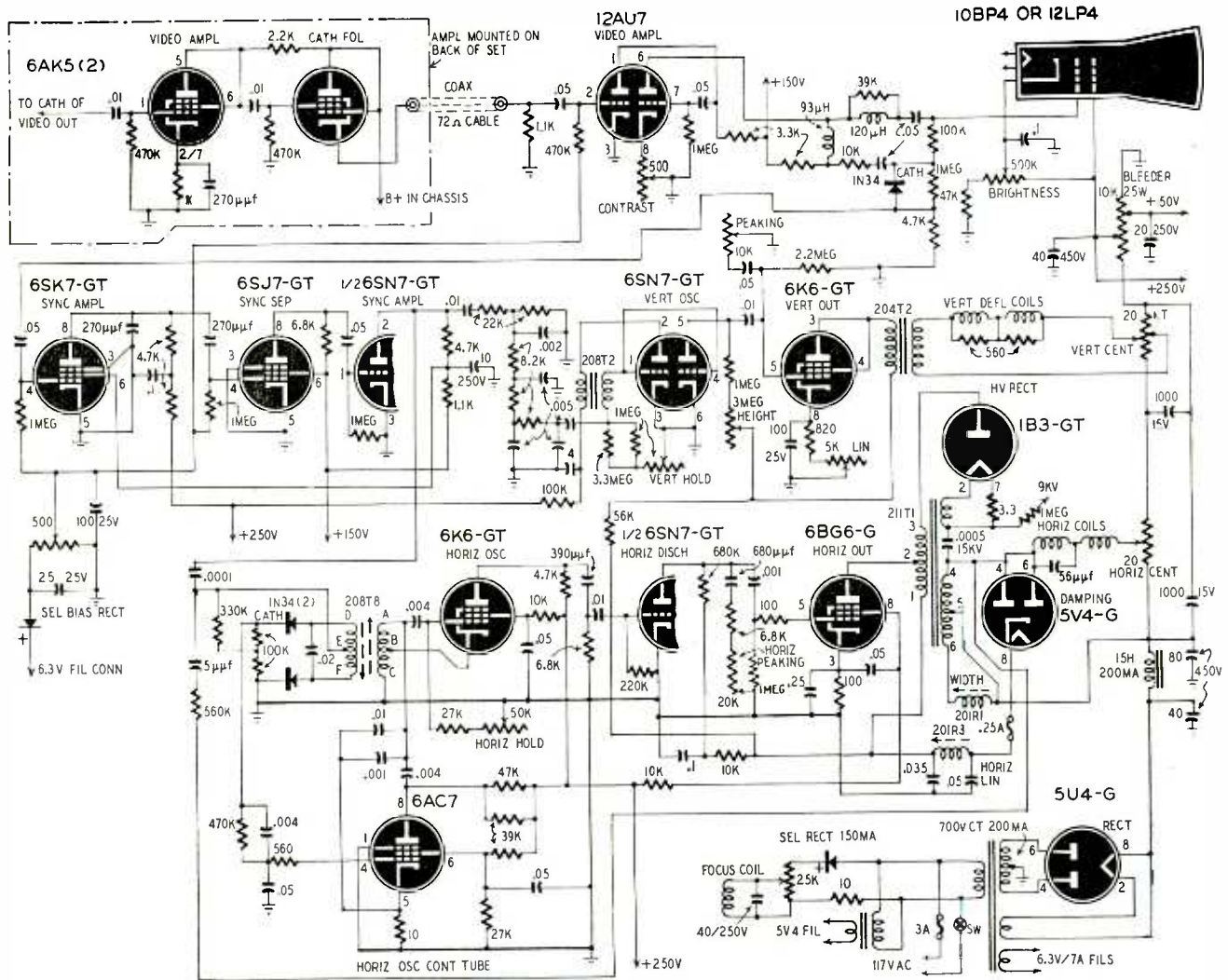

Fig. 1—Schematic of the TV slave. The 2-tube video amplifier at top left is mounted on the master set, the rest of the circuit fits on a separate chassis.

most sets made today. The numbers on the coils and transformers are all RCA parts numbers, but equivalents can be used.

The circuit has a few short cuts. One is the focus circuit. It uses an EM-PM coil and a selenium rectifier with a variable resistor. It works well and saves wear and tear on the power transformer which is small because it was the only one on hand at the time. Another is the bias supply for the sync and video amplifiers and the sync separator. Here another selenium rectifier is used, connected to one side of the filament winding. A third selenium rectifier supplies the audio amplifier, and also reduces the load on the power transformer.

The photographs show the general layout of the slave. It is built on a 9 x 18 x 3-inch chassis that was originally intended to hold a 5-inch scope, and for this reason it is rather crowded underneath. Other constructors would do well to use a somewhat larger chassis.

We use the 12-inch picture tube because it makes the set small enough to be carried around easily while still giving an adequate picture size. Those who may wish to use a larger tube can

easily do so by using a higher-voltage horizontal output transformer and a suitable deflection yoke for the larger tube. Horizontal and vertical sweep may have to be increased also for a larger tube.

Of course the set needs a cabinet, especially if there are children around, because there are some dangerous voltages. The cabinet that we use is made of 1/4-inch gum plywood. The front is made of a double layer of plywood with plexiglass in between and cut out for the picture tube. The base is made of 1-inch stock and houses the speaker.

We often use the slave in an upstairs bedroom and find that it gives a very good picture. In fact, sometimes it seems that the picture is better than the one on the original set. The main problem now is how to change stations and shut it off without getting out of bed.

Materials for TV Slave

Resistors: 1—3.3; 3—10; 2—100; 3—560; 1—820; 2—1,000; 2—1,100; 1—2,200; 2—3,300; 5—4,700; 3—6,800; 3—8,200; 4—10,000; 2—22,000; 2—27,000; 3—39,000; 2—47,000; 5—100,000; 1—220,000; 1—330,000; 5—470,000; 1—680,000-ohm; 9—1; 1—1.5; 1—2.2; 1—3.3; 1—10; megohm, 1/2-watt; 1—270-ohm, 1-watt; 1—10,000-ohm, 25 watt, with two adjustable taps; 1—20; 2—500; 1—5,000; 1—10,000; 1—20,000; 1—25,000; 1—50,000; 1—250,000; 1—500,000-ohm, 1—1; 1—3-megohm potentiometers.

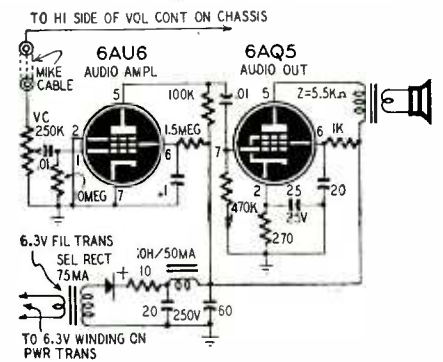

Capacitors: 1—56; 1—100; 3—270; 1—390; 1—680- μ mf, mica; 1—500- μ mf, 15-kv paper; 2—.001; 2—.002; 3—.004; 3—.005; 8—.01; 1—.02; 1—.035; 1—.05; 3—0.1; 1—0.25- μ f, 400-volt, paper; 2—1,000- μ f, 15-volt; 2—25- μ f, 25-volt; 2—100- μ f, 25-volt; 2—20- μ f, 250-volt; 2—40- μ f, 250-volt; 2—40- μ f, 450-volt; 1—60- μ f, 450-volt; 1—80- μ f, 450-volt, electrolytics.

Inductors: 1—93; 1—120- μ h, peaking coils; 1—vert osc, trans, (208T2); 1—vert output (204T2); 1—sync discriminator (208T8); 1—horizontal output and high-voltage trans. (211T1); 1—horizontal linearity (201R3), 1—width control (201R1); deflection coil, EM-PM ion trap coil (RCA part numbers are given; equivalents may be used); 1—power transformer, 750-volt ct at 200 ma, 6.3 volts at 7 amps, 5 volt at 3 amp; 1—5-volt, 3-amp, 1—6.3-volt, 2-amp, filament transformers; 1—audio output, 6AQ5 to v.c.; 1—15-henry at 200 ma, 1—10-henry at 50 ma, chokes.

Miscellaneous: 1—1B3-GT, 1—5U4-G, 1—5V4-G, 1—6AC7, 2—6AK5; 1—6AQ5, 1—6A6, 1—6BG6-G, 2—6K6-GT, 1—6SJ7-GT, 1—6SK7-GT, 2—6SN7-GT, 1—12AU7, tubes and sockets; 1—IN34 crystal diode; 1—150-ma, 1—75-ma, 1—bias, selenium rectifiers; 1—picture tube (10BP4 or 12LP4) and mounting assembly; 1—0.25; 1—3-amp fuses; loudspeaker, coax fittings, on-off switch on volume control, coax cable, microphone cable, chassis, hookup wire, assorted hardware.

— END —

New Video Circuits In Modern TV Sets

By EDWARD M. NOLL

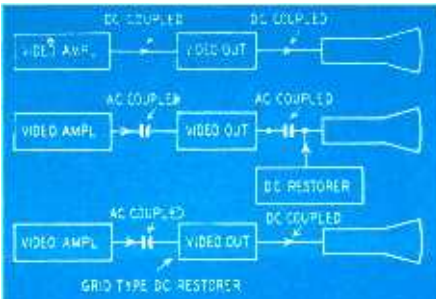

Fig. 1—Three types of video amplifier coupling. Each has certain advantages.

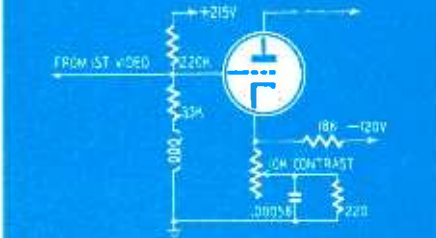

Fig. 2—Contrast control circuit used in some of the Capehart TV receivers.

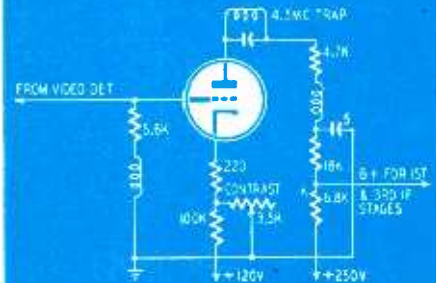

Fig. 3—One of RCA's contrast control circuits. Plate voltage varies automatically with the i.f. signal strength.

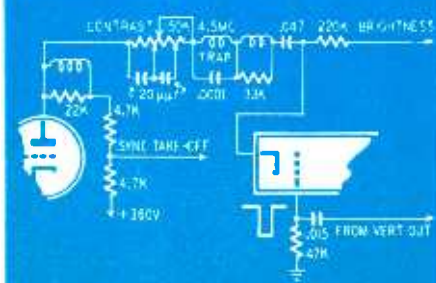

Fig. 4—This series type contrast circuit is one of Zenith's contributions.

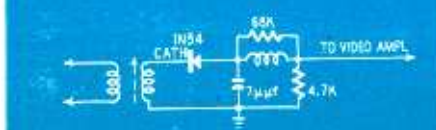

Fig. 5—The crystal video detector circuit which is used in many Zenith sets.

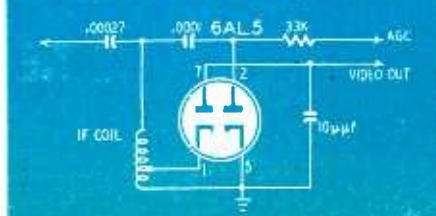

Fig. 6—Video detector and a.g.c. rectifier. This circuit is one of RCA's.

THE video amplifier is a hard-working unit in the modern television receiver. It has a gain of about 30 to bring up the signal level to excite the picture tube. A peak-to-peak level of about 60 to 75 volts is needed to swing the beam between blanking and peak white. Full swing means proper contrast (darkest dark to brightest bright). The video amplifier must have a gain that is uniform over a wide band of frequencies to reproduce the slow and fast changes in light intensity represented by the video signal. This is particularly so today when too many manufacturers have gone ultra-conservative in the i.f. section.

The video amplifier must retain average brightness. This d.c. level sets the average or background brightness of the picture. Picture contrast is also controlled in the video amplifier by a contrast gain control, generally in the cathode circuit of one of the video amplifier tubes.

Some additional functions and innovations in video amplifiers are sync take-off point, intercarrier take-off, trap circuits to minimize certain types of interference, noise limiting, correction for white compression, and a.g.c. take-off.

Basic video circuits

There are three basic video amplifier types (Fig. 1)—direct-coupled, a.c. coupled with diode restorer in the picture tube grid circuit, and a.c. coupled with grid circuit restorer at the video output tube. Each type has a number of advantages and a comparable number of problems. Manufacturers use all three types and seem to change from one to the other frequently.

A d.c. amplifier system, because of its ability to retain a d.c. component of average brightness, does not require any form of restoration. Low-frequency response is excellent. D.c. voltage levels are higher and more critical in value, filtering, and regulation. Tube failures are more common because of high potentials between some cathodes, grids, and heaters.

A.c.-coupled video amplifiers are most common. A d.c. restorer is needed to establish average brightness level at the grid-cathode circuit of the picture tube. Interstage R-C coupling networks and adequate low-frequency response are special problems in this type. In the third system, the d.c. restorer can be

eliminated by using the grid-cathode circuit of the video output tube as a restoration circuit. This means the video output tube must be direct-coupled to picture tube grid circuit. Gain and efficiency of the output stage is low because of biasing limitations.

Circuit techniques

Since the development of superior a.g.c. systems, contrast control has been assigned to the video amplifier. Usually it is a degenerative gain control in the cathode circuit of one of the video stages. This type of control regulates signal amplitude by degenerative feedback and not by changing stage bias and gain. A degenerative method is preferable because it prevents biasing the stage incorrectly on a compressed portion of the transfer curve. However, if the circuit is poorly designed, a change in bias will also occur as cathode resistance is varied. Such a shift could bias the tube incorrectly and cause video compression, sync clipping, or shift in black level. To prevent undue shift in d.c. bias when the contrast control is adjusted, the cathode is biased from a bleeder in the power-supply line. In the Capehart version, Fig. 2, the cathode circuit is bled from a -120 volt source. Bias changes only a small amount when the contrast control is varied, but degeneration becomes greater as more cathode resistance is added by the contrast control. Grid bias is negative despite the return to B-plus because plate voltage of the preceding stage (direct-coupled) is negative with respect to ground.

A similar contrast arrangement is used by RCA, Fig. 3. In addition, the plate voltage of this tube is regulated by the incoming signal level. As signal level increases, the d.c. plate voltage of the video tube rises with it. Thus the top of the sync pulse is not clipped when a stronger signal reaches the grid of this video stage (with higher plate voltage, cutoff occurs at a higher negative voltage). For a weak signal, the plate voltage is less and cutoff occurs earlier. This means there still is clipping of noise impulses slightly higher in level than the sync tip. At the same time, the sync tip itself is not clipped when a strong signal is received.

The change in plate voltage is brought about by feeding the video stage from the same supply line that applies voltage to the first and third

video i.f. stages. When a.g.c. bias increases with the reception of a strong signal, the plate currents of the two i.f. stages decrease. The voltage drop across the 6,800-ohm resistor is also less, and the plate voltage applied to the video amplifier stage increases.

Zenith inserts the contrast control in a series path between the video output stage and picture tube, as in Fig. 4. High-frequency response of the video band is kept at a uniform level by the small series capacitors as contrast is varied. As the contrast control inserts more series resistance into the path (less signal reaches grid of picture tube), the series capacitance also decreases (higher reactance), and highs and lows are attenuated a like amount. A parallel-resonant trap blocks any 4.5-mc beat from the picture tube.

Zenith continues to use a crystal video detector, Fig. 5, because the circuit is simple and has good signal characteristics. A suggested check for such a crystal is to measure resistance in both directions with an ohmmeter. A good crystal should read no more than 400 ohms in one direction and at least 25 times higher in the other.

The RCA chassis feeds the video detector and a.g.c. rectifier from different points on the last i.f. coil. The video detector is tapped off down on the coil (Fig. 6) so that the preceding stage is not loaded and so a high-level signal can be fed to the a.g.c. rectifier. The video detector conducts continuously and presents a low-resistance shunt across the tuned circuits to which it is attached. By connecting the video detector across just a low-impedance section of the coil, the circuit loading is minimized. Although the a.g.c. rectifier is attached to the high-impedance side of the coil, the loading influence is less because this diode does not conduct continuously, but only on peaks. Nevertheless a strong a.g.c. action occurs.

Picture tube circuits

Two unconventional video outputs to picture tube are shown in Figs. 7 and 8. The Du Mont chassis uses conventional a.c. coupling of signal to cathode of the picture tube while d.c. component of average brightness is introduced at the grid of the picture tube (Fig. 7). The cathode circuit has a low-impedance (short time constant) and does not hold the d.c. level as well as in the high-impedance grid circuit. A plus charge on C1 shifts with average brightness of the scene, the charge being held by a long time constant. The time constant at the restorer input is shorter to respond quickly to a change in brightness.

In the Capehart video output circuit (Fig. 8), the d.c. grid potential is held near ground potential despite direct-coupling from the video output tube. This minimizes the tendency of the grid to arc and short to the heater and other electrodes and prolongs picture tube life. The cathode of the picture tube operates just slightly positive with respect to ground and the grid is near

ground potential. The positive voltage on the video output plate side R3 equals the negative voltage applied to R4 so that the junction of the two resistors is near zero voltage.

The a.c. component across plate load R1 is capacitance-coupled in the usual manner through C1 to the grid of the picture tube. The d.c. component at the junction of R3 and R4 (at the grid of the picture tube) is correct because at the point the d.c. level is removed (plate side of R2), it is twice the level it would be at top of plate resistor R1. Resistors R3 and R4 are a voltage divider which applies the d.c. level at the grid of the picture tube at the very same level as at top of R1. Thus the a.c. and d.c. signal levels are true relative to each other and at the same time the grid is near ground d.c. potential.

Video amplifier response

It is simple to use your sweep generator and scope to make a response check of a video amplifier. An effective procedure is to apply marker generator and sweep oscillator outputs direct to the plate or cathode on i.f. side of the video detector, as shown in Fig. 9. Marker generator and center frequency of sweep oscillator are set to same frequency, say 15 megacycles. The two signals are applied at about the same level. If sweep width is adjusted for 5-megacycle deviation, a 0-5 megacycle sweep signal is developed across the video detector load resistor. This essentially linear sweep can be used as a video sweep to check the response of the video amplifier. The response pattern is picked up by a crystal probe at the picture tube grid-cathode circuit and fed to the scope. A typical crystal probe and a response pattern are shown in Fig. 10. The small notch at the left side of the response curve indicates the zero-frequency reference point. Markers can be put on the curve with an external oscillator.

A few typical defects indicated by response curves are shown in Fig. 11. Curve *a* shows a definite loss of highs. This might be caused by an increase in plate load resistance of one of the video stages. For example, an open plate decoupling capacitor would add the resistance of the decoupling resistor to the plate load. When there is capacitive loading of a video stage peaking circuit (such as from a tube whose capacitance has increased), resonance will be lower and give the peaked effect of waveform *b*. When resistive loading is present on a video stage or the plate load drops in value, gain at the low-frequency end falls off as in curve *c*. Fig. 12 shows these components of a video stage.

If the damping resistance opens, a high-end peaked response is obtained as in curve *d*. When the series peaking coil opens or is too high in value, a resonant peak again moves into the curve as shown on curve *e*. Response checks such as these are very useful for locating both serious and obscure defects in the video amplifier.—END—

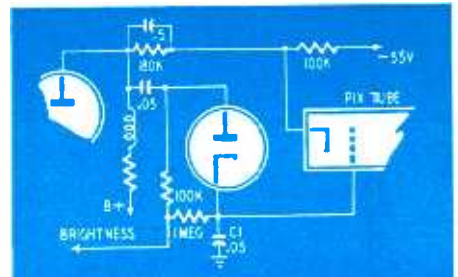

Fig. 7—A Du Mont coupling circuit to the picture tube grid. The d.c. component is restored at kinescope grid.

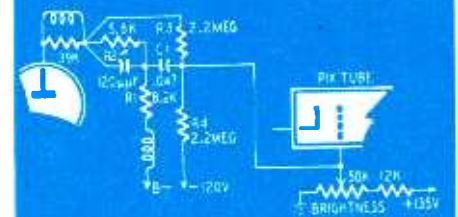

Fig. 8—Coupling circuit used in Capehart sets. Absence of high grid-cathode-heater potentials increases tube life.

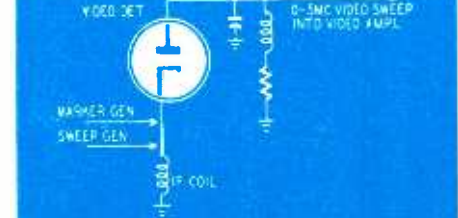

Fig. 9—A video sweep is generated by applying sweep and marker generators on the same frequency at the i.f. output.



Fig. 10—Crystal probe for picking up the video output. At right is a video response as it should look on a scope.

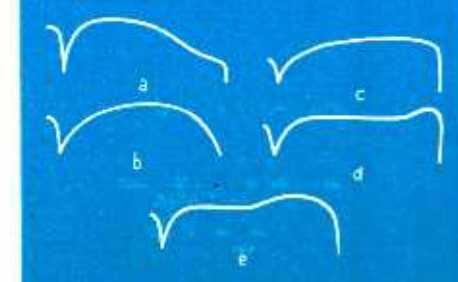

Fig. 11—Faulty video response curves. Text describes causes for these defects.



Fig. 12—Components of a video stage.

Television Service Clinic

Conducted By **WALTER H. BUCHSBAUM***

WHEN writing to the TV Service Clinic, please be as specific and detailed as possible. To give you an accurate and fast answer to your problems we must know the year and model of the TV receiver in question, the type of picture tube it uses; also either a complete tube list or else a list of those tubes under suspicion would help. A self-addressed envelope will lessen chance for error in addressing our letter to you. As you know, we answer all letters directly but reprint only those considered of interest to most of our readers.

Many readers have recently asked about converting receivers to larger picture tubes. In many cases they have attempted to use a 16-inch rectangular tube instead of a 10-inch tube without changing the flyback transformer and deflection yoke. Naturally they have encountered insufficient width, dull pictures due to low anode voltage, and neck-shadow due to an improper deflection yoke. When planning to convert to a 14-, 16-, 17-, or 20-inch rectangular picture tube, be sure to figure on a new flyback and yoke, and most likely a new focus coil as well.

Only after we know which type of transformer and yoke you are using can we tell you how to increase either the high voltage or the width or both. In most cases it is necessary to increase the sawtooth voltage driving the horizontal output amplifier. How this can be done depends on the type of horizontal oscillator used. In general, reducing the oscillator plate resistor or connecting the oscillator plate resistor to a higher B-plus point will also increase the driving signal on the output amplifier, but requires readjustment of the oscillator coil. Another way to increase this sawtooth voltage is to reduce the value of the discharge capacitor which actually determines the shape of the sawtooth voltage. Detailed data for getting enough width and high voltage on the many different receivers would require more space than we have available, but if you have this type of problem let us know and we will advise you as to the best solution.

In some cases where a single 6SN7-GT is used for the vertical oscillator and output amplifier, insufficient height results on a larger picture tube. Try substituting a new 6BL7 in the same socket. If the vertical tube is a 12AU7, substitute a 12BH7 in the same socket. (This will work only in receivers with parallel-connected filaments.) In either case more height will result and no circuit changes are required.

Many readers have asked about incorporating keyed a.g.c. in their present set. Unless you are capable of slightly redesigning a TV set, your best bet is one of the kits now on the market. These give full instructions.

A large number of television owners naturally want to convert their 7-inch electrostatic receivers for larger screen. Such conversions would require major design changes, therefore cannot be recommended. We are now trying to work out a simplified conversion for these sets, and will report the results in RADIO-ELECTRONICS as soon as a workable method is achieved.

Hum on channels 7 and 9

An Admiral TV receiver has audio hum on channels 7 and 9 only, and it cannot be removed with the fine tuning control. A new tuner installed on this set did not improve the condition.—J. Duller Radio Service, Chicago, Ill.

This hum may be eliminated by correct alignment of the picture and sound channels. See RADIO-ELECTRONICS for November, 1950.

If channels 7 and 9 are your weakest ones, dressing all video leads and those carrying the vertical sweep signal away from the audio section will help.

Checking tubes on a tube checker is insufficient, as the tube checker will not show up heater-to-cathode leakage.

As a final step, try signal tracing with an oscilloscope. This should locate the source of the hum.

Wants audio only

Can you tell me how I can listen to the audio portion of a TV program only while cutting off the high-voltage supply of my Bendix 6002U receiver? Also, I cannot find a 6SN7-GT or a 6BQ6-GT that will work in this set.—J. Bates, Paoli, Pa.

To cut off the high voltage, disconnect the cathode of the 6BQ6-GT output tube. If you also want to cut off the cathode-ray tube, break its cathode connection only.

In your case it may be a defective circuit rather than bad tubes. Try measuring all operating voltages on these tubes. If they appear correct, check the waveforms with an oscilloscope.

No sound or picture

The raster seems perfect on my model D Transvision Deluxe, yet I cannot get sound or picture. The audio section was checked by tapping the grids of the tubes for response, which was audible at the speaker. I have an oscillator and a multimeter to work with.—R. G. Hammond, Long Island City, N.Y.

Your trouble is most likely in the front end or in the i.f. stages which carry sound and picture. Check the a.g.c. bias, which should be 1 to 4 volts with a station tuned in.

Connect your oscillator to the mixer grid on the Du Mont tuner. Two to six volts d.c. should be developed on the second detector as the frequency is varied from 20 to 30 mc.

With the oscillator set to about 21.25 mc, vary the frequency slowly. Connect the meter to the FM detector output. You should observe an abrupt swing from positive to negative as the oscillator signal passes through the sound intermediate frequency.

If these tests do not locate the defect, the tuner itself may not be working. To check this or to trace the signal from the antenna to the output requires a signal generator covering the TV band and a sensitive v.t.v.m.

AM interference

A series of black bars run vertically on the face of my Admiral TV receiver. I live about a quarter of a mile from a radio tower, an AM station operating on 1340 kc. At times the audio cuts my picture and is heard on the TV set. When the station signs off, I get a pretty good picture. What causes this trouble and how can I eliminate it?—S. R. Mongell, Connellsville, Pa.

Interference from the AM station can be eliminated by installing a 1340-kc

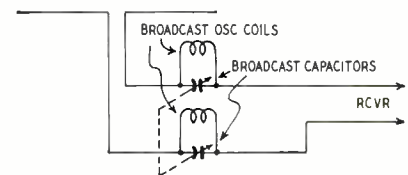

Fig. 1—Wave traps for broadcast TVI.

wave trap in the antenna. This can be made from an old AM radio 2-gang tuning capacitor and two oscillator coils as shown in Fig. 1. Shielding the bottom of the TV receiver chassis, the r.f. and i.f. tubes, and the video amplifier may help.

Picture troubles

A Motorola VT 71M-A loses brightness gradually and at the same time the image increases in size. Sometimes the picture suddenly vanishes, leaving a dim and blurred raster. The vertical oscillator drifts during warmup, and the adjustment of the horizontal sync is extremely critical. Sound is in no way affected.—A. E. Allen, Ypsilanti, Mich.

These are some suggestions to fix up your receiver.

*Author of *Television Servicing*, Prentice-Hall, 1950.

Change the 1B3-GT high-voltage rectifier tube.

Change the 12SN7-GT horizontal output tube and the 25L6 high-voltage oscillator tube.

Replace the selenium rectifiers if the voltage drops after the warmup period.

As a last resort, replace the picture tube itself.

Alignment problem

I have a model 629 Emerson TV receiver which, because of misalignment, no longer gives fine detail. I have tried interchanging tubes with no success. I have a junior Voltohmyst v.t.v.m. to measure high frequencies with. Can you give me details for building a crystal probe? Also please tell me how to couple the sweep generator to the receiver so that I can align it.—F. Kelczewski, Schenectady, N.Y.

A circuit for the probe appears in Fig. 2. To couple the sweep generator to the receiver, connect the generator

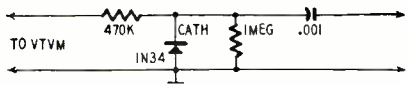

Fig. 2—A simple h.f. probe for v.t.v.m.

to an ungrounded tube shield slipped over the mixer or r.f. amplifier. Another method is to connect a 5- μ f capacitor in series with the generator and the grid pin.

Intermittent high voltage

The picture on a TV set blacks out completely for intervals of five minutes to an hour, and then it comes back.—J. F. Geier Radio, Pottsville, Pa.

If your screen blacks out completely, there may be an intermittent or partial short in the horizontal output transformer circuits. Check all wires to deflection yoke and horizontal output transformer. Replace the deflection coil, which is the most likely cause of the trouble. The damper tube may also have been affected by failure of the deflection coil. Try replacing it as well. If neither of these changes are effective, replace the width coil.

Vertical deflection ills

I have a Du Mont RA-109 TV set. The vertical linearity gets poor and the picture shrinks about one-half inch at top and bottom after the set has been on for approximately one hour. New tubes don't help. What shall I try next?—Albert Crumley, Philadelphia, Pa.

In this and other sets using similar vertical deflection systems, simultaneous loss of height and decrease in vertical linearity can often be traced to an increase in the value of the capacitor in the plate circuit of the vertical discharge tube or sawtooth generator. Check capacitors C312 (0.1 μ f) and C257 (.05 μ f) in the plate circuit of the vertical saw generator V219-B.

This trouble is also likely to be caused by failures or changes in the values of the 40- μ f electrolytics C294 and C288-B and the 25- μ f cathode bypass capacitor C288-C for the 6SN7-GT vertical output tube. —END—

Two-Band Antennas For TV Reception

Described in patent No. 2,510,010 issued to John D. Callaghan and assigned to RCA is a new high-frequency antenna system which consists of two stacked antennas, tuned to different frequencies and connected to a common lead-in or transmission line. The design of the system is such that the directivity patterns of each antenna are preserved. The method of coupling to the lead-in prevents energy from one antenna from feeding into the other. The low-frequency antenna has a stub which short-circuits signals within the range of the high-frequency antenna. The basic circuit is shown in Fig. 1.

Antennas A1 and A2 are tuned to frequencies F1 and F2, respectively. In this example, assume that F2 is twice F1. The antennas are connected to the lead-in through lines T1 and T2. T1 is three-quarter wavelength long at F2. An open stub T3 (one-quarter wavelength at F2) is connected to T1 at the center of the low-frequency antenna A1. Thus T1 plus T3 equals a full wavelength at F2. Therefore high-frequency signals collected by A2 pass down T2 into the lead-in. They cannot enter the branch line to the low-frequency antenna because the combination of T1 and T3 appears as a high-impedance at this frequency.

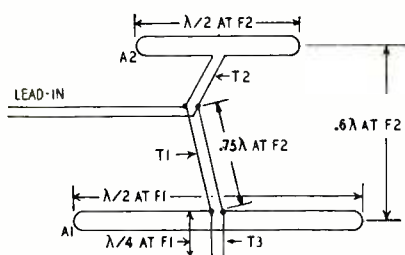

Fig. 1—Circuit of a 2-band TV antenna.

Being an electrical quarter-wavelength at F2, stub T3 short-circuits signals at this frequency which may

be picked up by A1 operating on its second harmonic. At frequency F1, T3 appears as a capacitive reactance across T1.

Branch line T2 has a length which with A2 appears as an open circuit at the lower frequency F1. Therefore, low-frequency signals cannot be fed into the high-frequency antenna.

If F2 is three times F1, line T1 which is three-quarter wavelength at F2 is also one-quarter wavelength at F1. A2 and T2 can be adjusted to present a slightly capacitive reactance across the lead-in to cancel the capacitive effect of T3 at F1.

Fig. 2 shows how high- and low-band TV antennas may be connected. The antennas are mounted so their wooden booms are 33 inches on center. T1, T2, and T3—sections of 300-ohm line—are 37 1/2, 12, and 12 1/2 inches respectively.

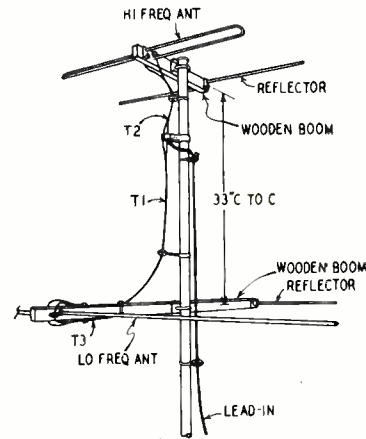

Fig. 2—Assembly of the new TV antenna.

T1, T2, and T3 are shown as parallel lines in Figs. 1 and 2. In practice, these may be any conventional transmission lines. —END—

Odd Television Conversion Troubles

A number of TV sets which we converted to use larger tubes have been brought back with complaints of intermittent picture and sound, no sound or picture, and blown fuses. In each case, the trouble was traced directly to the width control.

This coil is usually mounted on the wall of the high-voltage cage or on a grounded metal bracket on the chassis. It is held in place by a threaded metal fitting which supports the tuning slug. This method of mounting automatically grounds the core. After conversion to larger tubes, the B-plus and sweep voltages across the coil are often considerably greater than before conversion. The additional voltage may be high enough to puncture the thin-wall tubing between the grounded slug and the winding. When this happens, the B-plus is grounded with the result that

fuses are blown or the voltages reduced to the level where the set is inoperative.

In any complaint of this kind, you may save time by checking the width coil first. In most cases, the winding will be charred and the effects of the short are plainly visible.

A recurrence of the trouble can be prevented by mounting the width coil on a plastic strip. Make sure that the slug screw and the metal mounting are at least one-half inch from the nearest grounded metal.

According to Admiral, a similar trouble may occur in their 24D1 (16-inch) chassis if the lower rear mounting bolt touches the width control winding. This causes insufficient picture width. Place four or five washers under the head of the bolt to cure the trouble. Shorter bolts are being used on newer models.—RFS

Supersonic-Controlled FM For Bus – And Storecasting

The author describes the circuits used to increase volume or mute the set during FM broadcasts for store and transit systems

By W. H. COLLINS*

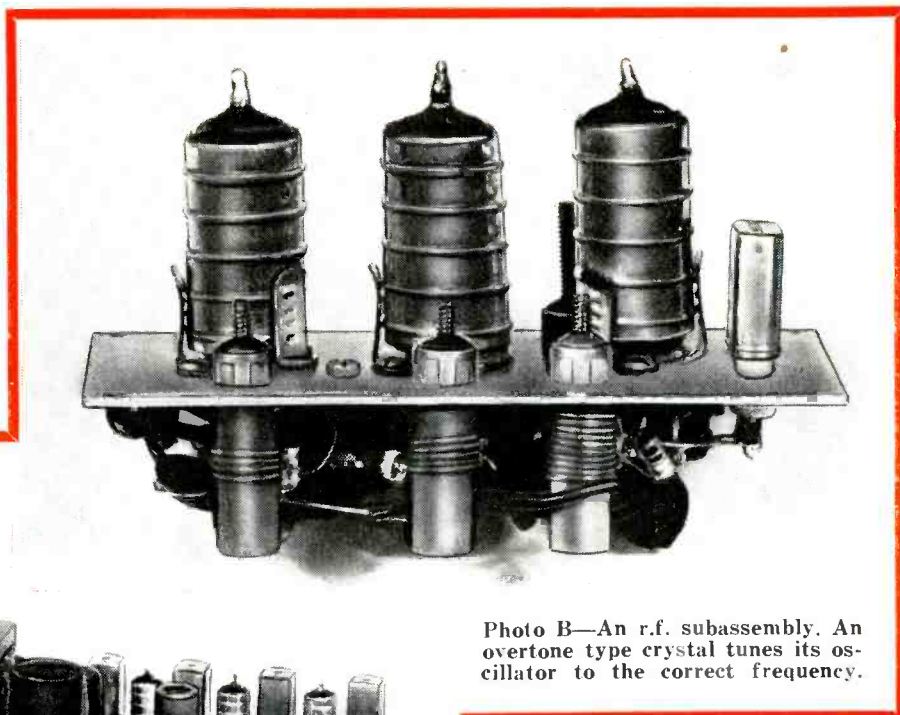

Photo B—An r.f. subassembly. An overtone type crystal tunes its oscillator to the correct frequency.



Photo A—This S-17-A-FM receiver, made by Collins Audio Products, is typical of those used for FM music service. It requires only a speaker and an antenna.

received in the wrong locations. In this case, the bus receivers are muted by 21 kc, the department stores, smaller stores, and factory sets by 17 kc, but the same 17-kc tone *boosts* the volume in the supermarkets, to put across the advertising message. During the commercial, the 17-kc tone is sustained, and upon its completion, the tone is removed to return the supermarket receivers to normal volume level. But what about the receivers in the other four groups? They too must be brought back to life. A momentary 15-kc signal restores the bus sets and 26 kc restores all other locations. Then the musical program resumes.

The use, service, and maintenance of this FM equipment requires skilled technicians who must understand the operation of the system before attempting to service it. No one is more upset than a user of this equipment whose set doesn't work right or allows commercial announcements to come through, particularly when no-announcement type of music service is paid for.

Special FM receivers and tuners which meet all the requirements of this work have been developed at the Collins Audio Products Company. These include a complete crystal-controlled, fixed-frequency FM tuner; and a mobile

SINCE the advent of television, FM stations have been looking for a new source of revenue to enable them to keep operating. By carefully programming musical numbers, without vocals, some FM stations have been able to sell a music service to local merchants and factories which is unexcelled in quality and variety, and at the same time is particularly economical. By using a broadcasting station for this service, a much wider scope of operation is opened up, both from coverage and fidelity standpoints, than wired music services can provide in all cases.

In store and transit broadcasting, the commercial announcement is reproduced at a higher volume level than the

music to command the attention of the listeners. When the music resumes, the volume again drops to its previous level. When desired, the receivers may be automatically muted by the radio station and again restored to operation. Supersonic signals from 15 to 30 kc transmitted from the broadcast station control the receivers.

Fig. 1 portrays multiple setup using all the facilities of a supersonic controlled FM system. When music is transmitted, it is received by all receivers at all locations. Suppose the program schedule shows that a breakfast cereal commercial is to be made in the supermarkets. Before the commercial is made, supersonic tones must be transmitted so that the announcement is not

* Collins Audio Products Co., Westfield, N. J.

receiver powered by batteries. The complete receiver appears in Photo A.

Most of the circuits are made up as subassemblies. For example, supersonic control frequencies vary with control station or area so that the "tone plate," as it is called, is assembled and wired separately. The same is true of the r.f. and i.f. units. The main chassis includes the output stage and power supply. This type of design also makes servicing easier.

Supersonic control circuits

When the supersonic tone, say 20 kc, is transmitted over the station's carrier, it proceeds through the r.f. portion and is demodulated by the detector circuit in the same way as the regular signal. Here, however, the 20-kc tone is taken directly off the discriminator cathode before de-emphasis and is amplified by the high-mu triode tube 12AX7 (see Fig. 2). The 12AX7 dual triode is used because of its high gain and its ability to amplify two separate signals. Photo C shows this subassembly.

In the plate circuits of the 12AX7 are two specially designed inductances which, when shunted with fixed capacitors, may be sharply tuned with a high-Q slug to the proper resonant frequency. The voltage developed across the coil is rectified by the 6AL5 and is impressed upon the grid of one of the 6AK6's.

The two 6AK6 tubes operate in a flip-flop circuit. At any specific moment, the plate voltage of one is much lower than that of the other because it is conducting. A negative voltage applied to the control grid of the 6AK6 which is conducting will cause the plate current to drop and the plate voltage to rise. Because the plate of each tube is cross-connected to the screen of the other, the opposite set of conditions occur to the other 6AK6 when this is done.

By alternately supplying a negative voltage to each of the 6AK6 grids, either one can be made to conduct. Plate

and screen voltages for the first audio tube (6SK7) are obtained by one of the 6AK6 tubes, the one we will call the "restore" tube. When the receiver is playing, the plate voltage on the 6SK7 tube is approximately 35 volts. When the set is muted, this voltage drops to 22, which is insufficient for the tube to operate and amplify, thereby silencing the audio. Assisting this condition is an added bias on the 6SK7 cathode.

When the radio station sends the restore pulse, the restore tube is cut off and it again supplies plate voltage to the 6SK7 and amplification is resumed. The duration of tones emitted by the radio station need be only two or three seconds to achieve operation. After the momentary transmission of the mute tone, the receiver remains silent until the restore tone is transmitted by the station.

The other circuits

Crystal control of the oscillator circuit is almost a must, as frequency stability is paramount. The r.f. section, shown in Photo B, has plate and grid tuning for high selectivity and to avoid intermodulation of strong r.f. signals in close proximity. An overtone type crystal operates at three times its fundamental frequency in the oscillator circuit. This frequency is again tripled in the plate-coupling coil, and is injected into the grid of the converter tube, a 6AU6, through a low value ceramic coupling capacitor.

The crystal frequency for a given station frequency is:

$$\text{Crystal freq.} = \frac{\text{operating freq.} - 10.7}{9}$$

If a station is operating at 100.7 mc, the crystal frequency is obtained in this manner:

$$F_c = \frac{100.7 - 10.7}{9} = 10 \text{ mc}$$

The antenna coil is tapped, which allows a low-impedance lead-in to be used such as 50- to 72-ohm coaxial cable. A 300-ohm ribbon line may also be used with slight modification. The intermediate-frequency amplifier

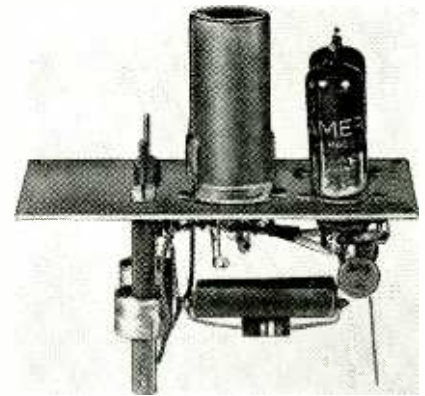

Photo C—This subassembly is the "tone plate," which cuts the set on or off, depending on the supersonic tone signal it receives from the transmitter.

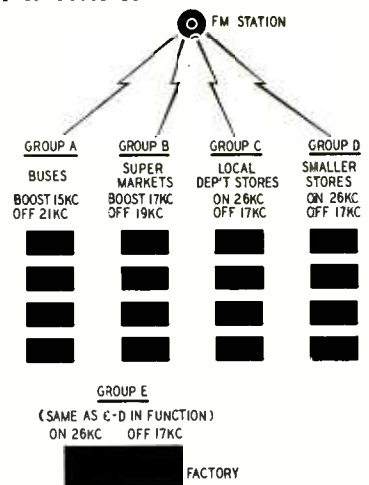

Fig. 1—This hypothetical system shows the possibilities of FM music service. Many stores and factories use it already, and its popularity is increasing.

has a three-stage circuit for high gain. Following this are two pentode limiters and then a conventional dual diode demodulator. This is built up in a complete unit as shown in Photo D.

A.v.c. is fed back to the first i.f. amplifier tube (6BA6) as well as to the first r.f. stage. This avoids overloading from very strong signals but allows full amplification on weak signals. The audio circuit of this receiver has

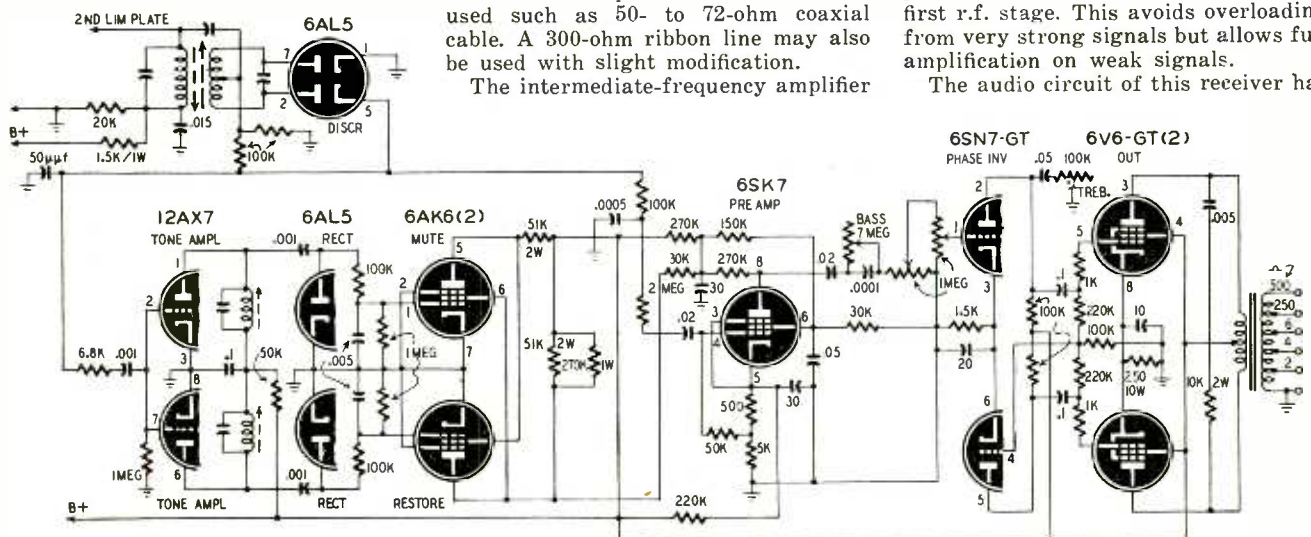

Fig. 2—The audio circuits of a music-service receiver. The 6SK7 is blocked when the mute tube is cut off, unblocked when the restore tube is cut off. High-Q tuned circuits select the tones which control the set's audio channel.

a 6SN7-GT phase inverter and two 6V6-GT's in push-pull arrangement. Fig. 2 also shows this circuit. The power output is 6 to 10 watts which is more than sufficient for a half dozen speakers in a typical installation. For requirements where more power is required, the R-12-A tuner is recommended, which may be used with any conventional amplifier.

Installation

The requirements for general radio listening are not critical from a transmitted power viewpoint, and a momentary break in the program due to atmospherics is quickly forgotten. With a music system, however, a strong signal must always be present at the receiver antenna for consistent results. It is not wise to work out too far from the station where the signal is only 25 to 50 microvolts. Even though a receiver has a sensitivity of 5 microvolts, a 50-microvolt signal contour can easily drop to zero momentarily during a storm or extreme atmospheric pressure changes. If one of the control pulses is being transmitted during such a period, the set cannot respond, and a commercial will be received or the set will be left muted, as the case may be. This is one reason why a good antenna installation is so important.

A very rough rule-of-the-thumb estimate is that about 2,000 watts of power is required for each 5 miles from the station. For example, if consistent operation is desired at 35 miles, 14,000 watts should be available, remembering, of course, that the curvature of the earth seriously hampers FM reception beyond about 50 miles. Working at a distance of 50 miles from the station requires a special receiving antenna and a power contour of the transmitted pattern.

Due to the high sensitivity of the set, almost any antenna will work in locations close to the transmitter. The one possible exception occurs if there are "dead spots" where there is a high order of man-made static or interference.

If there is a good signal of several hundred microvolts over a radius of 15 to 20 miles, a short length of wire may be used with the receiver. However, the performance of the set will dictate how long or high an antenna is required. Do not discount the possible advantage of a good antenna installation where the power of the transmitter is low or interference is high. The terrain is another thing to consider. If there are mountains, valleys, or tall buildings between the transmitter and the receiver, the signal may be reflected or altered in its characteristic and cause inconsistent operation. Under such circumstances, the higher and more elaborate the antenna system, the better. To overcome as much as possible the chance of noise pickup in the lead-in wire, the antenna input circuit has been designed for use with 50- to 72-ohm coaxial shielded cable.

Adjustments

Although the receivers are aligned, tuned, and adjusted at the factory for maximum performance at the designated frequency, certain field adjustments are necessary at the time of installation. This is because the test equipment cannot exactly match the operating frequency of the station. These adjustments include peaking the antenna circuit to compensate for antenna length and position. The discriminator must be balanced to place it exactly on frequency. The discriminator circuit is rather broad and considerable detuning or out-of-balance condition can be tolerated and still provide acceptable re-

ception. But operation of the supersonic control circuits depends entirely on the amount of energy developed at supersonic frequencies, so that precise setting of the discriminator is mandatory.

The r.f. unit and i.f. amplifier are peaked with a vacuum-tube voltmeter connected between the a.v.c. return of the first limiter tube and ground. With the set receiving the station, the tuning slugs are adjusted for maximum deflection of the meter.

After these adjustments have been made, the receiver is ready to be left on location if the supersonic control is working. The installer should remain with the set until he is certain that this most important part of the receiver is operating satisfactorily.

— END —

HUM MODULATION

A bad case of hum modulation ruined reception on a new AM-FM set whenever we tried to use it with an outside antenna. The trouble was finally traced to the design of the antenna circuit.

In the original circuit shown at *a*, the primary and secondary of the AM antenna coil are connected together and grounded through a .05- μ f capacitor. We

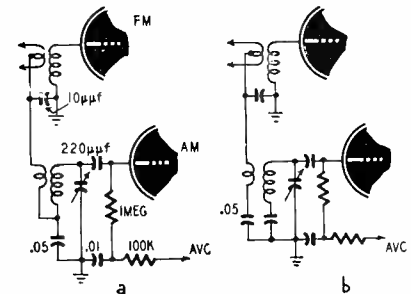

Antenna circuit for AM-FM receivers.

cleared up the trouble by disconnecting the windings and grounding the primary through a separate .05- μ f capacitor as shown at *b*.

Circuits similar to the original are used by several manufacturers, so it is wise to check the antenna coil or loop whenever hum modulation is encountered in new receivers.—L. H. Trent

FM LIMITER ALIGNMENT

Service technicians often have trouble aligning limiters in FM and TV sets. This occurs commonly in sets having slug-tuned i.f. transformers with the limiter grid resistor in series with the secondary. Tuning is broad and sound distorts on any signal strong enough to operate the limiter. It seems that the heavy limiter current saturates the core. The set sounds better and is easier to align when the limiters are shunt fed. Disconnect the grid resistor from the winding and connect it directly to the grid. Ground the bottom of the winding, then connect a capacitor of approximately 50 μ f between the grid and the top of the winding. Experiment with the value of the grid resistor.—Robert Francis.

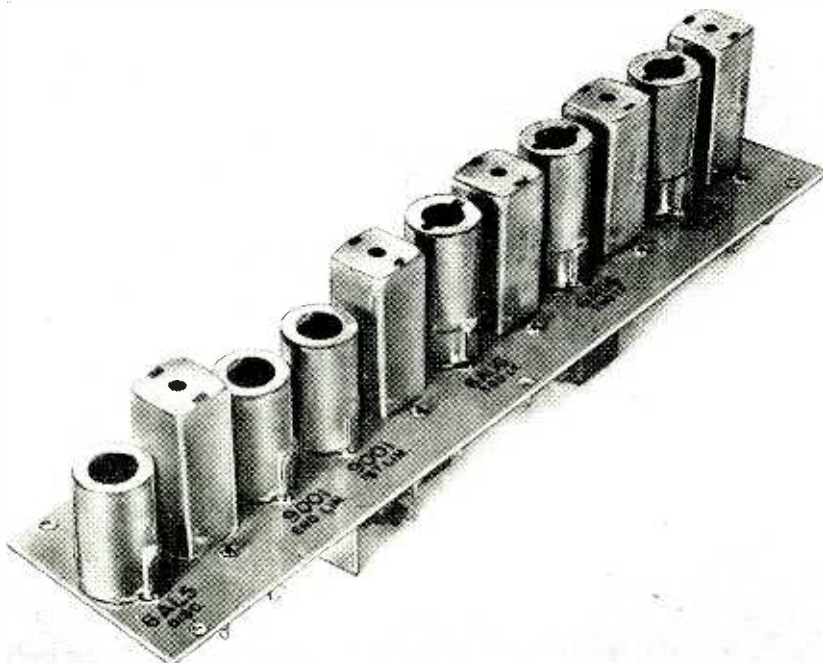

Photo D—The i.f. strip has three i.f. tubes, two limiters, and discriminator.

Emission Type Tester Checks Subminiatures

By EDWIN N. KAUFMAN



Photo of the subminiature tube checker.

MILLIONS of subminiature tubes have been manufactured in the past few years, but the commercial market offers no satisfactory tube tester for checking them. As most devices using subminiature tubes are crowded for space, replacement of a tube is often a difficult job, further aggravated by the possibility that the replacement tube might be defective. Failure in subminiature tubes is usually due to an open filament, low emission, or microphonics. These faults are easily detected by this emission type tube checker designed by the author.

At first thought it may seem an easy product to design, but it presents a number of problems. For instance, Raytheon tubes have short leads (CX) which directly plug into subminiature 5-, 6-, or 7-contact sockets, or long leads (AX) which are soldered directly into a circuit. The long leads are difficult to plug into a tube socket and also are difficult to clip to. This is because four or five clip leads spread the tube leads out so far that the glass tube lead seals are in danger of cracking. The Victoreen tubes are exceptionally hard to test because the tube leads are long and are in a square pattern, with one lead in the center of the square. The Raytheon tubes have various filament voltages and current ratings.

Two different instruments have been constructed. Model 100 tests tubes with 1.5-volt filaments only. The second, a more elaborate instrument, model 101, checks filament voltage so that both 1.5-volt and 6-volt tubes can be tested. A safety feature on the pictured tube checker (model 100) consists of a test switch S2 which prevents either filament or plate voltage from being applied to the tube to be tested until the switch is pressed; then the emission is read. This prevents filament burnouts due to the leads twisting against each other when inserted into the tube socket, or to possible misplacement of leads, as it permits a double check before the test switch is thrown. Model 100 is diagrammed in Fig. 1, and model 101 in Fig. 2.

Two methods have been used to connect to the tube checker tubes which do not have socket leads. One has a

plastic block with metal-lined contact holes (model 100), while the other requires soldering to small terminal lugs, properly spaced. Tiny clips have been used, and are a possibility, but we prefer soldering pins, which will be discussed further. This method of attaching long-lead subminiature tubes is tedious if any quantity are to be tested, but it does provide for a positive test. Subminiature tube sockets can be obtained from any radio wholesale house,

factory in the circuits they were designed for. Electrometer tubes must be handled with care during the testing procedure so that the base of the tube does not become dirty from moisture, dirt, or grease from the fingers. This includes care in soldering so that neither does the rosin flux splutter on the base nor heavy flux fumes surround the base.

A tube tester of this type is a necessity any place where subminiature tubes are used. Persons unfamiliar with these tubes should get tube data sheets from the various tube manufacturers. Many different types of these tubes can be obtained and they have many uses other than in hearing aids and nuclear equipment. For example a very small multitube portable radio can be built using these tubes. (See RADIO-ELECTRONICS for March, 1951.) They also lend themselves to model airplane remote-control applications.

Construction pointers

Constructing the tube checkers diagrammed here is relatively simple. The chassis size is 7½ x 4½ x 4¼ inches for the model 100 tester. A D'Arsonval meter of about 100 microamperes is used, but a meter from 50 to 200 microamperes is satisfactory. One or two 7½-volt C batteries and a push-or-rotate-to-test switch of the appropriate number of contacts (see diagram) will be required. The other parts are easily obtained standard resistors and switches.

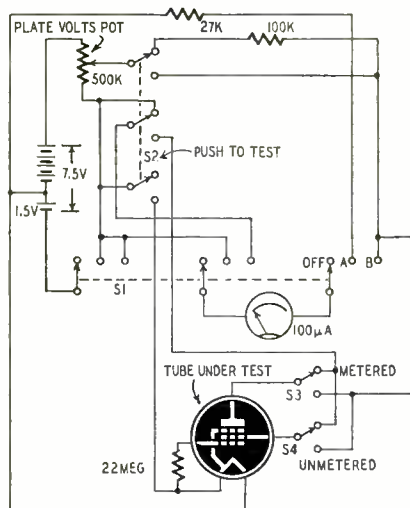

Fig. 1—Schematic of Model 100 checker.

to be used with tubes requiring sockets.

It is advisable to adapt one of the two tube testers diagrammed to test only a few specific tubes. For instance, tube checker model 100 was designed mainly to test Victoreen tubes VX41A/5800 and VX32B/5803 and the Raytheon electrometer tube CK571AX. Model 101 tests all 1.5- and 6.0-volt tubes. Generally it will be sufficient to test 5 or 10 sample tubes and allow a plus or minus 10 to 20% to find what a tube's plate emission should be. Tubes with higher than normal emission may cause as much trouble as tubes with low emission.

Defective tubes usually are so low or so high in emission that there is no doubt they are defective. The amount of microphonics that is permissible depends on the circuit the tube is used in. Some tubes are extremely bad, microphonically speaking, but are still satis-

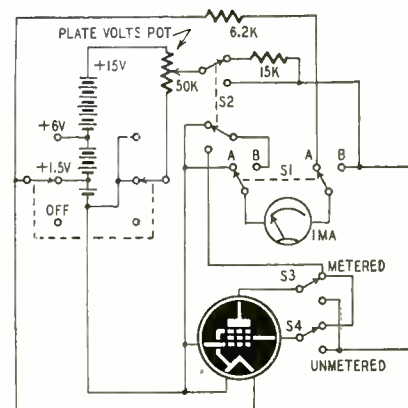

Fig. 2—Circuit of Model 101, which is for 1.5- and 6-volt subminiature tubes.

In some instances it will pay to have provision to test Raytheon tubes with both short and long leads as well as Victoreen and Sylvania tubes. The tube tester illustrated (model 100) has two tube sockets which are wired in parallel, one for Raytheon tubes and one for Victoreen tubes. The two center contacts shown between these two sockets were for experimentation only and are not being used now. The tube socket as used in the pictured tester can be made on a piece of lucite or some other plastic about $\frac{1}{2}$ inch thick, 1 inch wide, and 4 inches long. Cut about a foot of $\frac{1}{16}$ -inch hollow brass tubing (obtained from any model airplane shop) into 10 pieces $\frac{3}{8}$ inch long. Lay out two socket holes as shown in Fig. 3 on the lucite block, spreading the socket holes about $\frac{3}{16}$ inch apart. Drill through the lucite with a No. 52 drill. Press the brass tubing into the lucite until it is flush. Solder the tube tester leads to the exposed ends of the tubing, being careful not to block the open end of the tubing and not to

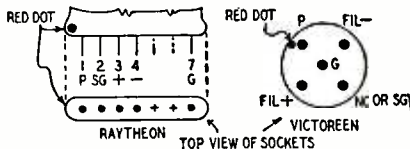

Fig. 3—Typical tube base connections.

spoil the lucite with too much heat. Install the socket block as illustrated in the photo. If it is preferred to solder the tube leads to a terminal instead of using the insertion socket, follow the above procedure but cut the brass tubing to $1\frac{1}{2}$ -inch length and allow $\frac{1}{2}$ inch of the tubing to stick above the lucite block. Notch the end of the brass tubing for ease of soldering the tube leads.

Operation

Both models of the tube tester operate the same way, and the procedure is simple. Once the tube is attached to the tester, the meter reads the filament current when switch S1 is in position A. Then, in model 100, switch S1 to position B and adjust the potentiometer so that the meter reads correctly for the tube being tested. The meter need not be calibrated in volts, as long as the correct reading for any particular tube type is known. S3 and S4 can be set so the meter reads either plate or screen current, or they can be set so the meter reads their sum.

Model 101 is used in the same way, except that a switch is included for changing the filament voltage.

Materials for Tube Checker Model 100

Resistors: 1—27,000; 1—100,000-ohm, 1—22-megohm, $\frac{1}{2}$ -watt; 1—500,000-ohm potentiometer.

Miscellaneous: 1—1.5-volt, 1— $7\frac{1}{2}$ -volt batteries; 2—s.p.d.t., 1—3-pole, 3-position, 1—2-pole, 3-position switches; 1—100- μ a meter; chassis, hookup wire, assorted hardware.

Materials for Tube Checker Model 101

Resistors: 1—6,200; 1—12,000-ohm, $\frac{1}{2}$ -watt; 1—50,000-ohm potentiometer.

Miscellaneous: 1—d.p.d.t., 1—2-pole, 3 position, 2—s.p.d.t. switches; 2—7.5-volt batteries (one with 1.5- and 6-volt taps); 1—1-ma meter; chassis, hookup wire, assorted hardware.

—END—

Signal Tracing System Eliminates Time Waste

By JOHN D. BURKE*

WHAT is the best method of signal tracing?

The sensible thing is to divide your radio in half, and again in half, and so on, to the exact location of the trouble.

The halfway-point in a radio set is the second detector. In that vicinity, the volume control is the best single spot for a number of signal tracing tests. Therefore we move now—and this may be very soon after the set came out of its cabinet—to the top of the volume control (the terminal to which the arm rotates when on full).

Here you can find three kinds of voltage. The signal, which is supposed to come through your i.f. stages, is there in its i.f. waveform. Not so strong as it appears at the second detector diode or grid, but enough so you can pick it off, measure it, and listen to it through your tracer.

If you are using a tuned tracer, you can, as the author does with his modified Hickok Indicating Traceometer, distinguish between the i.f. and audio voltage, which is also present at the top of the volume control. This cannot be done with an untuned tracer.

The other voltage normally present here is the a.v.c., if the set uses the volume control as a diode load. Otherwise, a.v.c. will be found just the other side of a coupling capacitor.

Another simple test at the volume control is a finger test to determine the condition of the audio stage and the loudspeaker. A loud roar, screech, or "grid hum" normally comes out of the speaker. If weak, suspect trouble.

A.v.c. is always very conclusive. If the a.v.c. swing seems normal as you tune across local stations, you know that the signal is reaching the second detector and is being rectified into a.v.c. voltage. A.v.c. can be checked by a v.t.v.m., electron-ray tube, or 20,000-ohm-per-volt meter.

These tests take only minutes—even seconds. You are at the crossroads. Turn toward the front of the set, or the back, according to what the top of the volume control has told you.

Your signal tracer can lead you to the particular parts or tubes at fault. In the following procedure each of the possibilities need not be checked one by one,

* This article is based on a chapter in *Rapid Radio Repair*, a book recently published by the same author.

but they are given as practical examples of what may be found.

Furthermore, this method accounts for the possibilities of intermittent trouble and of several troubles in combination. By keeping the volume control as our "base of operations" we can move freely in either direction.

The front end

Let us say the trouble calls for a turn to the front—no signal, weak signal, modulation hum, distortion, or intermittency.

Shall we plod or leap? Let us leap—to the plate of the mixer tube. (Most radio sets use a converter-mixer.) Here we find another interesting spot. Several voltages here—normally two of which are strong: the d.c. plate voltage, and the i.f. signal voltage (if the oscillator is working, if a station is tuned in, if the oscillator is beating with it at the proper frequency, if the plate circuit is tuned to the proper frequency—and all else is well).

With our tuned tracer, we check for the i.f. signal.

If our tracer is not tuned, we check for signal at the mixer plate, and hope that it is the i.f., not the incoming signal which has not been battered about as it should have been by the oscillator. Since the plate is supposed to be tuned to the i.f. frequency (and it probably is if no one has been playing with the screws), you won't hear much unless the oscillator is working. If it seems not to be, jump to the oscillator grid with a v.t.v.m. or sensitive meter and check for a negative voltage (say, 2 to 15 volts).

If our tracer is tuned, we can easily handle any oscillator troubles. If untuned, we at least know that the trouble is in the oscillator and proceed accordingly.

With an oscillator working, presumably at the right frequency, and still no proper signal, we know that our trouble is in the converter tube itself, the r.f. input circuit, the r.f. stage (if there is one), the bandswitch (likewise), the antenna coil, or possibly the a.v.c. If we have a tuned tracer, we test at an incoming r.f. signal right up to the antenna. If untuned we do our best. At any rate, we are about to pin down any trouble, and already know its general location.

We have skipped the i.f. stages. Suppose all is well at the mixer plate. Go

back to the i.f. plate (if more than one i.f. stage, go plate to plate) and find all sorts of possible troubles, many of which are the same as might be found in the r.f. or mixer.

Oscillation:—due to defective tube, too high screen voltage, open screen or plate bypass, open a.v.c. bypass, lack of shielding, loop too near the i.f., grid wire too near plate wire, ground wire off socket, etc.

No amplification:—open coil, open screen supply, shorted screen or plate bypass, dead tube, tube getting no filament (or heater) voltage, open grid circuit, open cathode circuit, grounded grid circuit, etc.

Sometimes i.f. trimmers are at fault. They may have been turned (by you perhaps?), and there's nothing deader than a radio with its i.f.'s out of line.

Once in a long while you may find a shorted i.f. trimmer. Check the resistance of the coils with an ohmmeter. If too low, suspect a short. If too high, it may be either a break in the circuit with a high-resistance contact (which causes bad noise), or, sometimes Litz-wound coils have one or more strands not soldered, and the Q falls way off.

Hum:—a cathode shorted to a heater, in the i.f., r.f., or mixer, will inject hum which is heard only when a station is tuned in—off station, no hum. (Hum modulation.)

Noise:—noisy tubes, loose connections, loose shields, poor sockets play havoc in the i.f., r.f., and mixer.

The audio end

If all is well at the top of the volume control—as far as the i.f. signal reaching that point is concerned—and there is trouble between that point and the listener's ears, how do we proceed?

Again we skip—to the output tube (or tubes). *We switch to audio tracing.* How is the signal at the grid (or grids)? At the plate (or plates)?

If O.K. there, we move on to the loud-speaker and output transformer and look for:

Open voice coil. Broken or loose flexible leads causing a rattle in the speaker.

Open secondary (rare). Shorted secondary (rare).

Some defect in the primary (common).

No magnetism due to field coil open. Voice coil rubbing or jammed. Iron filings, especially in auto sets. Broken connections.

Tone control capacitors shorted or arcing over on high volume. Stiff, torn, or dried up cone; or one that someone has "fixed".

If all was not well at the output tube plate, and at the grid the audio signal was good:

Shorted coupling capacitor causing the output tube grid to be positive, or at least, not sufficiently negative. Positive voltage on grid due to gassy or otherwise defective tube. (This may take a little time to develop as the set warms up.)
Open grid circuit.

Open cathode resistor (usually caused by a shorted plate-to-cathode capacitor or by a positive voltage on control grid causing too high a current through the tube).

Bad tube—tube tester may show "good"—try substitution.

Insufficient voltage—plate, screen, or filament.

Wrong bias.

Open cathode bypass.

Bad filter capacitor—you'd be surprised.

Output transformer not matched to tube.

Mismatch in push-pull stage.

Inverter circuit or tube defective.

We are back now, to our combination second-detector, first-audio tube. Some sets separate these two functions; most commonly they are in one tube. If the signal is O.K. in its i.f. waveform at the top of the volume control, *but does not appear as audio* of good quality and strength at the *plate of the first audio tube*, look for:

Bad tube.

Defective volume control.

Open coupling capacitor.

Shorted r.f. bypass at plate of first audio.

Open screen.

Open or shorted screen bypass.

Open or shorted mica capacitor.

Open or wrong value plate resistor.

Open or wrong value cathode resistor or circuit.

Grounded grid.

Open or wrong value grid resistor.

Leaky coupling capacitor which allows a.v.c. voltage to reach the first audio grid.

Possibly i.f. voltage is insufficient for detection—check again. (A very few sets have a squelch circuit. You may run into this.) Or the plate circuit may have its own filter which is shorted. Open cathode bypass is another possibility, or something wrong in the diode circuit (possibly tuned circuit is shorted, not in alignment, or has a loss due to high resistance somewhere).

We are back now from our little tour of a radio set. Somewhere along the road we have found and promptly cured one or more troubles. The set is playing. How well depends on several factors which will require more study on the part of those who want really to master this trade.

The author uses this approach to repairing radio sets every day, as the owner, sole mechanic, and the man-who-must-be-able-to-fix-everything-that-comes of a one-man repair shop in New York City. It works so well that he advertises, "Service While You Wait."

—END—

V. T. V. M. Uses Inexpensive Meter

Most vacuum-tube voltmeters are designed around a d.c. meter having sensitivity of 500 microamperes or higher. Such instruments are relatively expensive and many constructors hesitate to use them because their movements are delicate and easily damaged. A simple a.c. v.t.v.m. which can be constructed from an inexpensive 1-ma meter and a few other components is described in *Radio en Televisie Revue* (Antwerp, Belgium).

The circuit consists of 6F5 and 6C5 amplifiers and a 6K5 indicator tube. The meter is connected across a resistance bridge which has the 6K5 as a part of one of the arms. The bridge is balanced and the meter zeroed by adjusting the 600-ohm variable resistor in

the negative leg of the power supply.

The instrument reads full scale with 20 millivolts applied to the grid of the 6F5. The voltage divider across the input provides for full-scale ranges of 20, 100, and 500 millivolts, and 1, 2, 10, 50, and 100 volts. The input resistance is constant at 5 megohms on all ranges.

The instrument may be calibrated by connecting it across the output of a variable a.c. source in parallel with an accurate a.c. meter. The accuracy of this and similar instruments depends on careful calibration and the use of precision resistors in the voltage divider. These resistors should have an accuracy of 1% or better if the calibration is to be correct.

—END—

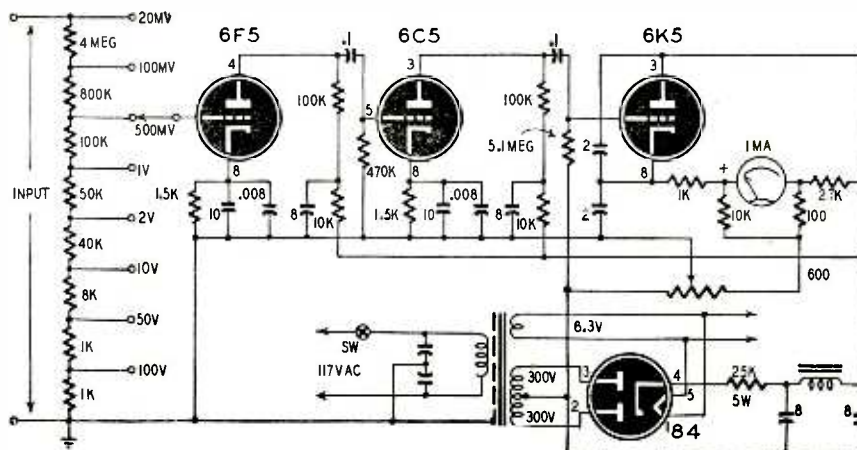

Low-Cost Oscilloscope is Easy to Build

By

ROBERT C. SANFORD

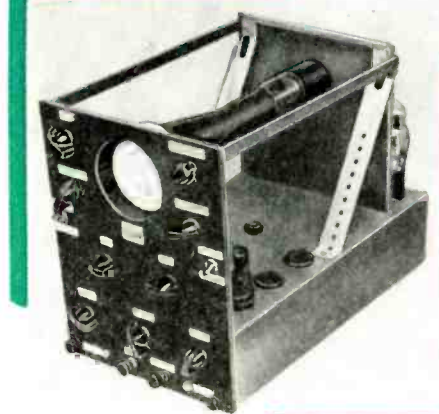
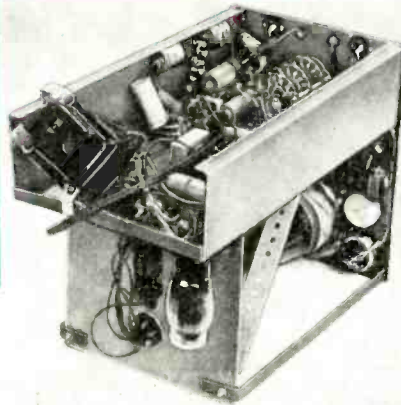

Photo of the instrument. Its design is simple, yet adequate for most needs.



Underside of the scope. The transformer is mounted askew to reduce hum.

This three-inch scope will fit the needs of most radio servicing and home experiments.

WHY not make a stab at making your own oscilloscope? Too complicated, and too expensive? Not so—if you do all the work yourself, and cut a few corners.

A scope for AM and most FM work needs only ordinary amplifier and sweep circuits. These are fairly simple for the average constructor. The circuit for such an instrument is shown in Fig. 1.

Each section of the scope should be considered separately. They are:

1. The C-R tube and high-voltage power supply.
2. The low-voltage power supply.
3. The amplifiers.

4. The sweep circuits.
5. The synchronization circuits.

Power Supplies

The high-voltage power supply depends on the C-R tube used. The most common service scopes use a 3-inch tube which needs 1,000 volts d.c. to operate. This poses the problems of power transformer, rectifier, and input filter capacitor. The average small power transformer has a secondary of 350-0-350 volts, which will give 700 volts across the entire secondary. The peak value of this is 1.414 times 700, or approximately 1,000 volts. This will provide enough d.c. voltage for the tube as the current drain is negligible.

Using a half-wave rectifier and the entire secondary, the output with no load will be this peak value. Since the C-R tube draws practically no current, and the bleeder has very high resistance, it is almost the same as no load. This 1,000 volts is filtered by a 0.5- μ f capacitor which must have a voltage rating of 1,500 or more to be safe. Using a cheaper, low-voltage capacitor here may result in blowing a rectifier tube, so it is worth a little extra expense.

The rectifier tube should have a maximum inverse peak voltage rating of over 2,000 volts. This is the 1,000 volts peak of the power transformer, plus the voltage across the filter capacitor. This means a 2X2/879 or some similar tube. A 5Y3-G was used in this circuit because no other tube was avail-

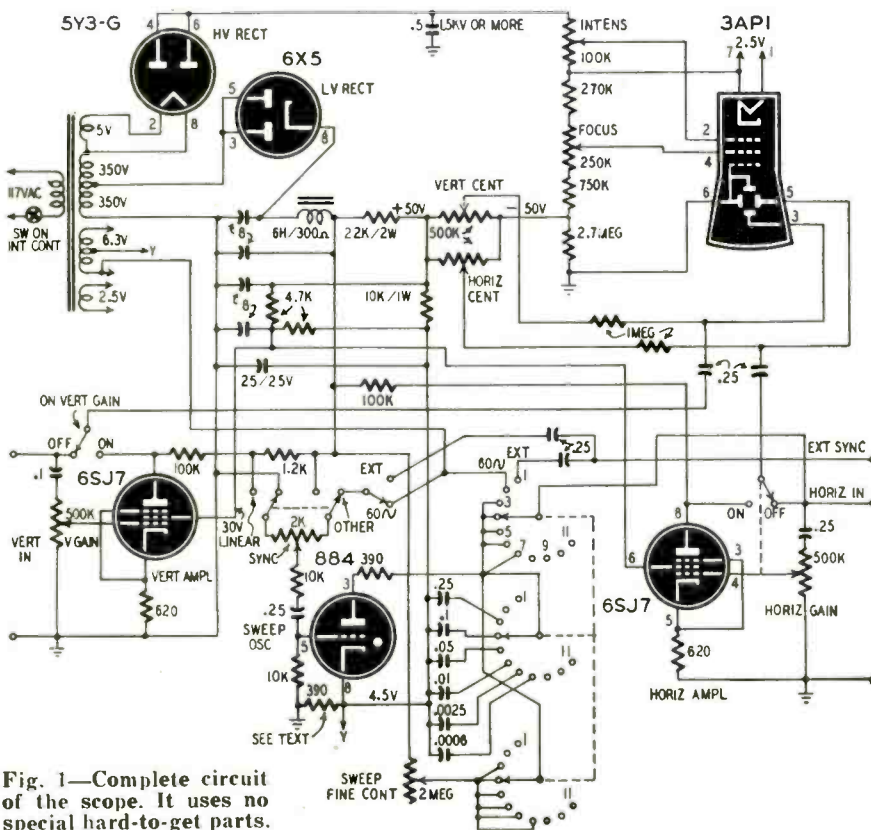

Fig. 1—Complete circuit of the scope. It uses no special hard-to-get parts.

able at the time, even though it has a peak inverse rating of only 1,400 volts. Used as a half-wave rectifier, there is current flow in both halves at once, and when not conducting, both halves are dead.

This power supply operates with a positive ground, and the elements of the C-R tube that are hot are the filament, cathode, grid, and, to a lesser degree, the focusing anode. When checking voltages, remember this, and save yourself a nasty shock. The load is a voltage divider, providing adjustable voltages for the grid and focus, and the negative centering voltage. This is shown in Fig. 2. The centering controls go from a negative 50 volts on the high-voltage supply, to a positive 50 volts which is obtained from the low-voltage supply.

The low-voltage supply shown in Fig. 3, is half-wave, using the center-tap of the power transformer. This gives a 300-volt d.c. output, with the negative side grounded. The load is a voltage divider giving the screen voltage for the amplifiers, 50 volts for the centering controls, and a low voltage (3 to 8 volts) for the bias on the gas tube sweep oscillator.

Greater control of centering is possible, if desired, by making the two

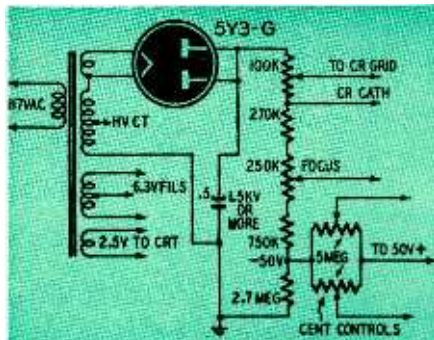

Fig. 2—The high-voltage rectifier circuit supplies a negative 1,000 volts.

centering voltages greater than 50 volts. This value was chosen for the 3-inch tube because it has a deflection sensitivity of 75 volts per inch. This means that 75 volts gives a deflection of 1 inch on the screen. Halfway to each side of the screen from the center is 3/4 inch, or about 50 volts. Certain types of traces, such as audio oscillators swept through the range for audio response curves, may need further control of centering to get half the picture only on the screen.

Since both power supplies are half-wave, the filtering must be better than usual. The ripple frequency is 60 cycles, instead of 120. Poor filtering in the low-voltage supply is noticeable as a 60-cycle pattern on the screen. Poor filtering in the high-voltage supply is not normally noticeable, as it causes no deflection. Any hum voltage is applied to the elements of the C-R tube, and will intensity-modulate the spot. If a Z-axis is included, the filtering must be good enough to eliminate this modulation.

Amplifiers

The amplifier response should be as nearly flat as possible over as much of the range as is to be examined. Television uses pedestals for synchronizing pulses, which are similar to square waves of short duration, or high frequency. If a square wave is shown on the screen, and the amplifiers have poor low-frequency response, the front edges of the wave will be rounded. If there is poor high response, the trailing edges will be rounded, or slanted.

Low-frequency response is improved by using large, low-voltage electrolytics across bias resistors, large screen bypasses, large coupling capacitors, and large electrolytic capacitors across plate-filter resistors, if any. High-frequency response is improved by using pentodes, low values of plate resistors, and keeping wiring capacitance low. The amplifier circuit is shown in Fig. 4.

Most scopes have provision for switching the input to the deflection plates directly, or through the amplifiers. Two panel controls are eliminated if you put s.p.d.t. switches on the amplifier gain controls. When the controls are thrown to zero gain, the switch throw connects the plates direct to the input.

Time base circuits

The picture on a scope screen is a graphical representation of a voltage waveform. The signal goes positive or negative (up or down on the screen)

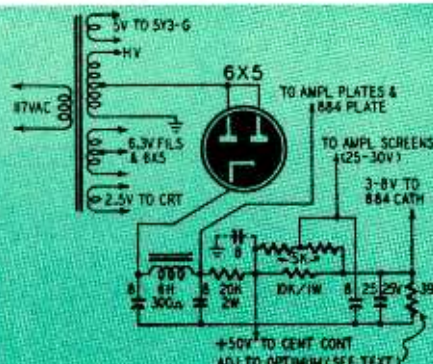

Fig. 3—The low-voltage rectifier connects to the transformer's center tap.

while time passes. Time is represented by a steady movement from left to right across the screen, and the voltage that produces this steady, linear movement, is called a sweep. The perfect sweep would be one that sweeps the trace across the screen at a constant rate, and then flips it back to the beginning instantly, to start another sweep.

A voltage that will accomplish this slow movement and then a fast retrace is in the form of a sawtooth, as in Fig. 5. The slow build-up of the sawtooth is the gradual movement across the screen, and the sharp drop at the end is the quick retrace. This voltage may be produced in several ways, but usually is from a gas tube such as the 884 or 885. These tubes ionize at a

high plate voltage, producing a low-resistance path from cathode to plate, then de-ionize at a low plate voltage. The grid is supplied from a low-voltage negative bias supply, and controls the ionization voltage. More negative bias means high ionization voltage, and less negative voltage means lower ionization voltage.

The plate of the tube is fed by a resistor, and is bypassed to ground or cathode by a capacitor. When the switch is thrown, the capacitor starts charging to the supply voltage. The larger the capacitor or resistor, the longer this charging takes. When the voltage across the capacitor (plate voltage) reaches the tube's ionization voltage, the tube fires and discharges the capacitor. When the voltage across the capacitor drops to the de-ionization voltage of the gas tube, the tube stops conducting, the capacitor starts charging, and the process repeats.

The voltage across the capacitor is the output sawtooth voltage. If the tube fires before the capacitor gets very far along on its charging curve, the output sawtooth voltage is practically linear. If the bias on the gas tube is too low, the ionization voltage will be too high, and the sawtooth will have a curve on the charge portion instead of a straight line. The bias should be adjusted for maximum output, while keeping the sawtooth linear. The frequency of the sweep oscillator is set by an adjustable capacitor across the plate, and the plate resistor is made variable for fine frequency control.

The linearity of the sweep oscillator can be checked approximately by feeding a known waveform, such as a sine wave (from the secondary of a filament transformer), to the vertical input. If the waveform crowds up at one end of the sweep, the linearity needs adjustment. A more accurate way is to feed sharp pulses (obtained by differentiating a square wave) to the vertical input. The pulses will be equally spaced if the sweep is linear.

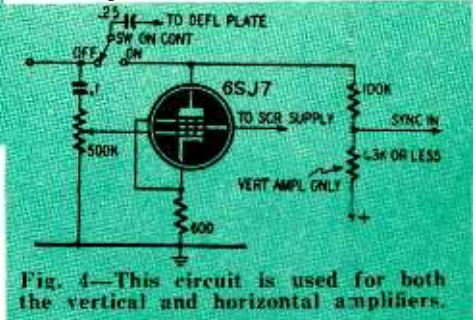

Fig. 4—This circuit is used for both the vertical and horizontal amplifiers.

The upper limit of frequency for gas-tube oscillators is 15,000 to 20,000 cycles, due to the time necessary for the tube to de-ionize during each cycle. Vacuum-tube oscillators, such as multi-vibrators, will give higher frequencies, but are not necessary for most scope work. The sweep amplitude should be high enough, so that when used with the amplifiers, it will spread the pattern several times wider than the screen. If the amplifiers do not have a fairly wide range, the sawtooth sweep will be

distorted and will result in distorted patterns on the screen.

Synchronization

You can now adjust your pattern on the screen, till it shows what you are after, but you will find that it drifts slowly across the screen, no matter how carefully you adjust it. The synchronization (SYNC) control, allows a small portion of sync signal to be fed into the grid of the gas-tube oscillator, which causes it to lock-in or synchronize with the pattern being studied, and makes it stationary. This voltage causes the gas tube to fire slightly earlier or later than normal, to effect the lock-in.

Sync signals are usually a small part of the output of the vertical amplifier, but provision is generally made for internal 60-cycle sync, and connection to some external source. Commercial scopes isolate the sync signal from the gas-tube grid through a 1-to-1 transformer, but it is simpler and cheaper to

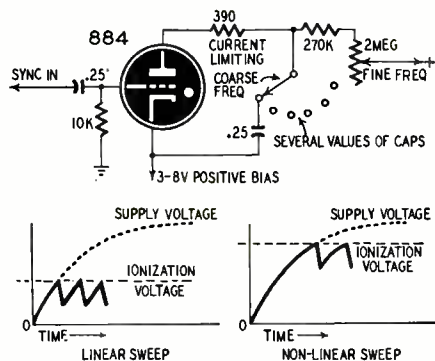

Fig. 5—The sawtooth generator hookup with linear and nonlinear waveforms.

tie it in through a coupling capacitor as shown in Fig. 6. If you do this, you may find that it over-synchronizes at times. This can be checked by running an r.f. signal into the vertical amplifier, and observing the pattern. Over-sync shows up as a slanting of one end of the pattern from the vertical, and if the low voltage filtering is insufficient, the slanted end will take the form of an ellipse, due to 60-cycle hum in the vertical amplifier plate circuit.

For most work, this effect is not serious, and may be reduced by reducing the value of the series plate resistor used to feed the sync signal into the gas tube. Over-sync is the bugaboo of all who first operate a scope. The less sync you can use, the better your pattern.

Construction hints

Always remember that the high-voltage supply is dangerous and that the elements of the C-R tube that should be safe are *hot*. This 1,000 volts probably won't kill you, but it may make you wish it had.

The centering controls go to positive and negative voltages that are supposed to be equal. If they are not, some of the bleeder resistors may burn up due to current flowing from one power supply to the other. Treat the amplifiers as you would any other high-gain

amplifiers, and keep the leads short and direct, with plate and grid circuits well separated. Keep the sweep circuits away from other circuits, and, if possible, shield them from the rest of the scope. They may produce r.f. hash under certain conditions.

Isolate all incoming signal circuits with at least a 0.25- μ f capacitor, and

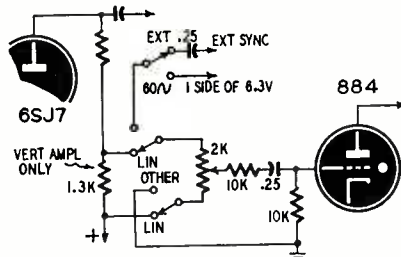

Fig. 6—A circuit for applying a sync signal to the gas tube sweep generator.

be careful when working on a.c.-d.c. equipment. A capacitor in the ground lead is the best bet. If at all possible, get a power transformer designed for scopes, as it will be magnetically shielded. The author used a simple replacement transformer, and had to mount it askew under the chassis to avoid magnetic deflection. Check filament windings on the power transformer, and see that all the windings are separate. The author wired his and then found that the 2.5- and 6.3-volt windings were one single winding, tapped for the lower voltage. This meant taking it apart and winding two separate filament windings in place of one.

If magnetic deflections bother you, whether from the power transformer

or external fields, a piece of 3-inch iron pipe will stop them; just place it around the C-R tube. Electrostatic pick-up may be reduced by enclosing the scope in a complete cover of sheet iron. Use shielded mike cable for leads, and phone plugs and jacks for connectors. Power supplies built on a separate chassis, and kept away from the scope, comprise one way of minimizing deflection difficulties.

The author used a 3AP1 C-R tube, which has a 2.5-volt filament. The 6.3-volt equivalent is the 3BP1, and both are available on the surplus market at very low cost.

No layout has been given, for everyone has his own ideas. Mount the power transformer directly behind the C-R tube if possible, even though you have to build a bracket to support it. Use a ring-type socket for the C-R tube, and cut the ring so that it doesn't quite complete a circle. This will give a loose mounting, and allow the C-R tube to be rotated to get correct positioning. The author mounted three spare sockets, and some other spare parts, in his, to take care of future developments.

Materials for Oscilloscope

Resistors: 2—390, 2—620, 1—1,200, 2—4,700, 2—100,000, 1—270,000, 1—750,000-ohm, 2—1, 1—2.5-megohm, 1/2-watt; 1—10,000-ohm, 1-watt; 1—22,000-ohm, 2-watt; 1—2,000, 1—100,000, 1—250,000, 4—500,000-ohm, 1—2 megohm potentiometers.

Capacitors: 1—600- μ f, mica; 1—.0025, 1—.01, 1—.05, 2—.01, 6—0.25- μ f, 400-volt, paper; 1—0.5- μ f, 1,500-volt, oil filled paper; 4—8- μ f, 450-volt, 1—25- μ f, 25 volt, electrolytics.

Miscellaneous: 1—350-0-350 volt power transformer with 6.3-, 5-, and 2.5-volt windings; 1—6-h, 300-ohm choke; 1—5Y3-G, 1—6X5, 1—884, 1—3AP1, 2—6SJ7 tubes and sockets; 1—s.p.d.t. switch on vert. gain control; 1—s.p.s.t. switch on horizontal gain control; 1—s.p.s.t., 1—d.p.d.t., 1—3-pole, 11-position, switches; chassis, hookup wire, assorted hardware.

— END —

Revamping the Chanalyst

The RCA-Rider Chanalyst is one of the most versatile signal-tracing instruments. Its r.f.-i.f., a.f., oscillator, and meter channels can be interconnected so the performance of any of a receiver's stages can be continuously monitored. In the average test setup, the test cables drape down over the workbench where they are always in the way. This disadvantage is easy to eliminate by making some revisions in the phone jack circuits.

Substitute two midjet 2-circuit phone jacks (Mallory type A-2A or equivalent) for the open-circuit jacks at the inputs to the meter and audio channels. The original wiring of these jacks is shown at *a* and the revisions are shown at *b*. The channels interlock automatically when test cables are removed from the r.f.-i.f. and a.f. input jacks.

In early models, the wattmeter receptacle and audio output jack are on the back of the instrument. These models can be modernized by installing the wattmeter receptacle in place of the meter-zero control and mounting the audio output jack below and to the right of the oscillator tuning control. Mount the meter-zero control on a strip fastened between the brackets support-

ing the indicator tubes. This control will be some distance behind the panel so it must be fitted with an extension shaft.

The oscillator channel of the Chanalyst can be used for signal tracing in the i.f. amplifier strip of FM receivers. Use the audio probe for the first i.f. stage and the r.f.-i.f. probe for the second i.f., limiter, and detector circuits.—
L. H. Trent

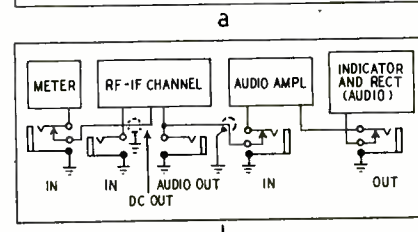
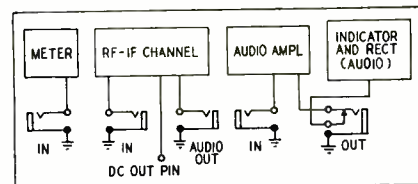

The original test jack wiring is at *a*, and *b* shows the revamped jack circuit.

Designing A Signal Generator

This 5-band variable-modulated job is easy to build and covers all the technician's normal requirements

By R. G. YOUNG

SOME time ago I looked at my old (so-called) signal generator and decided it was high time it joined the junk pile.

Not that it did not work—in spite of the fact that it consisted of no more than a refurbished one-tube blooper (see Fig. 1)—but I felt something more modern and preferably a.c. powered was desirable.

A seemingly nice little circuit (Fig. 2) found in a magazine caught my fancy.

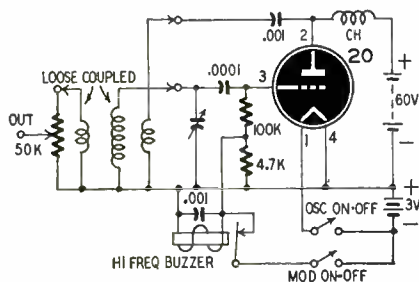

Fig. 1—The old blooper was outmoded.

When built, it certainly seemed a nice job; neat, compact, and everything. On test it belied its good looks.

It certainly oscillated with vim and vigor; but when the modulation was switched on, the signal spread all over the band. In other words, alignment of receivers by ear was impossible.

Before throwing it out, however, I tried it on a receiver when unmodulated, using a v.t.v.m. on the diode load to get an indication.

Another snag then showed itself. Adjusting the output altered the tuning. Not much, it's true, but enough to cause confusion on a sharply tuned receiver. The old blooper outshone it easily!

It was at this stage I decided on my requirements, which are fairly average:

A. Simple output control good enough, but variable over a wide range (down to a few microvolts) with vernier adjustment.

B. Tuning to be rock-solid, once set.

C. Modulation depth to be adjustable from zero to overmodulation. Overmodulation facilitates finding the signal on a receiver badly out of alignment.

It seemed the best plan to use two separate (r.f. and audio) oscillators, coupled through a mixer tube to output

control. See Fig. 3. Since the oscillators are isolated from each other, any type could be used.

A transistor is always said to be a steady and stable oscillator. One such arrangement is shown in Fig. 4. This oscillator operates by negative transconductance between the screen grid and the suppressor grid of r.f. pentodes. By coupling screen and suppressor with a capacitor, any tuned circuit connected between these grids and ground will oscillate at its natural frequency.

On assembly, however, it did not seem as good as might be expected. In the first place, it was none too keen on starting to oscillate, although, once started, it continued to do so. I found it necessary to click the power switch to shock-excite the tuned circuit into action after warmup.

Altering resistance values helped a little, but values seem rather critical, a 20% variation making an appreciable difference, and each individual tube of the same type required a different resistance.

This was not the only trouble. The unit also had the rather strange characteristic of suddenly shifting frequency (about 1 kc at the lower end of broadcast band) at irregular intervals.

"Suddenly" is meant quite literally; the shift was with a definite "click" in the loudspeaker.

Several tube specimens were tried, as the shift seemed likely to be due to electrode (grid) movement. All suf-

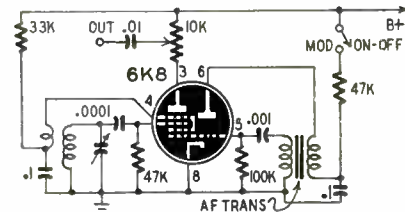

Fig. 2—Hookup for a 1-tube generator.

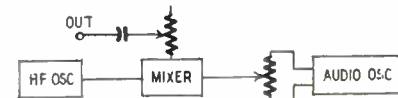

Fig. 3—Block diagram for a signal generator. Mixer isolates r.f. from a.f.

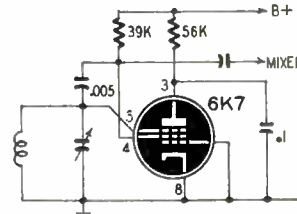

Fig. 4—The transitron was tried but discarded because it is too critical.

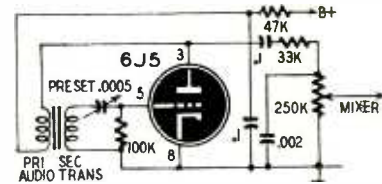

Fig. 5—Circuit of the audio modulator. The variable capacitor selects pitch.

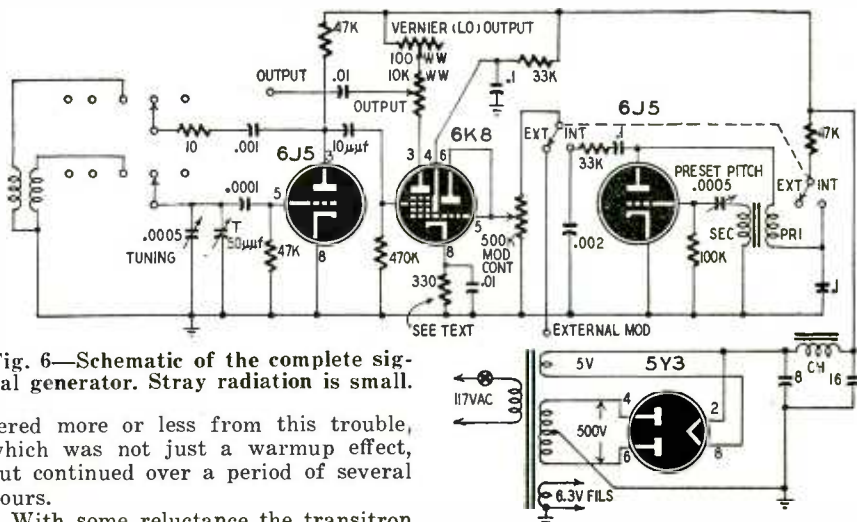

Fig. 6—Schematic of the complete signal generator. Stray radiation is small.

fered more or less from this trouble, which was not just a warmup effect, but continued over a period of several hours.

With some reluctance the transitron

was scrapped, because wave changing was delightfully simple—just a single pole switch! But its queer ways just could not be tolerated, particularly as it was no improvement on the old blooper (in fact, not as good in many ways).

The audio oscillator gave no trouble at all. It is shown in Fig. 5. The R-C network is included to eliminate high harmonics and keep the bandwidth narrow.

It did not oscillate on first assembly, but reversal of the audio transformer primary soon put that right. The transformer in the audio oscillator circuit can be any audio interstage unit that has a turns ratio of about 3:1.

The present capacitor gives a useful variation of pitch over an octave or so.

The choice of oscillators lay between the blooper, using a tickler coil, or the electron-coupled oscillator (beloved of ham radio), using a tapped inductor.

The tickler-blooper circuit was the final choice, not because the e.c.o. is not a good idea, but because by adjustment of tickler winding size, it is possible to obtain a wider sweep of frequency on each range with the separate winding.

The final design (see Fig. 6) was eminently satisfactory, and oscillated smoothly on all bands, although with some variation of output over the range. This was not considered to be very important, since the generator was not intended for laboratory tests.

All went well until the unit was mounted in a box intended to screen any strays as well as keep the dust out.

So long as the works were exposed to the sky there was no drift; but when enclosed, a slow drift set in caused by the coils warming up. This drift lasted about two hours before thermal stability was reached.

All kinds of remedies were tried, but none proved efficient on test.

Probably this drift could be corrected by using temperature compensating capacitors in the r.f. oscillator circuit. This did not seem a worthwhile refinement for the uses for which the generator was built.

So now the generator is used with no box. Contrary to expectations, the direct radiation is very low and cannot be picked up easily even a yard away.

Coil Data			
Band	Range	Tuning coil	Tickler
1	380 to 1,000 kc	150T No.	100T No.
		30 B&S	48 B&S
2	550 to 1,500 kc	100T No.	75 T No.
		30 B&S	48 B&S
3	1.5 to 4 mc	40 T No.	30 T No.
		30 B&S	48 B&S
4	4 to 10 mc	15 T No.	12 T No.
		30 B&S	48 B&S
5	10 to 30 mc	6 T No.	7 T No.
		22 B&S	48 B&S

Since it is not intended to deliver output below about 10 microvolts, this does not matter at all. If it did, the generator can be put in its box and allowed the requisite two hours of drift.

The layout of the signal generator is

not critical if a few simple precautions are followed. Mount the oscillator coils close to the bandswitch to keep the leads as short as possible. This is especially important for the higher frequency bands whose coils should be mounted nearest the switch. Keep all the r.f. leads as short and as neatly dressed as possible to avoid stray pick-up and radiation.

There is a space behind the coils on the chassis for any future additions, such as wobblers, etc.

As it stands, it will cover 99% of all normal AM requirements and can even be used as a phono-transmitter, if desired. If the cathode bias resistor is made adjustable (0-2,000 ohms), a

much greater depth of modulation can be obtained without distortion than is usual with these devices.

The table shows data for the coils. Wire gauges are not at all critical and are a guide only. The tickler coil is spaced $\frac{1}{8}$ inch from the tuning coil on ranges 1 and 2, touching on range 3, and wound on top of the tuning coil on ranges 4 and 5.

Coils on ranges 1, 2, and 3 are jumble wound, ranges 4 and 5 close-wound. Silk-covered or enameled wire may be used. Coils may be adjusted in position by shifting turns or stripping off a turn or two to get the stated ranges. When adjusted, they may be shellacked.

- END -

Noise Suppressors Aid Ignition

Since radios were first put in cars, most automotive and radiomen alike have viewed the needed noise-suppression systems as a setback to motor performance.

Any time a motor turned out a poor performance, odds were that its resistor-suppressors would receive most of the blame, even if they did contribute most to ignition noise suppression. And this reasoning seemed logical. Resistors, by their very physical nature, cause electrical loss which in turn drops motor performance.

Or at least so the argument went—until the U. S. Army Signal Corps set out to find exact answers which could be applied to military vehicles. Exhaustive tests, recently completed at the Signal Corps Engineering Laboratories at Fort Monmouth, New Jersey, brought many important facts to light.

First of all, the use of resistor-suppressors by no means brings on horsepower loss or reduced engine economy, the Signal Corps found. And there was another question: What about the effect of resistors on cold weather starting? Wouldn't their use tend to make a tough job even tougher?

The engineers conducted their tests and came up with the answer to this all-important question:

Suppressors don't hinder cold weath-

er starting. *On the contrary, they actually improve it.*

So that actual field conditions might be simulated in the tests, a used Army vehicle, rather than a brand-new one, was employed as guinea pig. The vehicle selected was a quarter-ton four-by-four truck which had already clocked 21,335 miles. Its performance to begin with was below par.

Then, too, the tests were so arranged that if any discrepancies did occur, they would show up in favor of *not* using the suppressors.

Doing away with the use of such starting aids as primers and heaters, the engine used in these experiments was started 18 times out of 18 tests, at temperatures from -30° F to -40° F with resistor-suppressors applied in the spark plugs, distributor, or both, in an average cranking time of 57.3 seconds and at an average of 77% rated primary voltage on the induction coil during cranking.

With no resistor-suppressors in the ignition system, the engine started in only 1 (at -30° F) out of 13 attempts in the same temperature range, with an average cranking time of 215 seconds and at an average of 79.2% rated primary voltage.

The principal effect of inserting a resistor-suppressor of approximately 10,000 ohms at the spark plug appeared to be smoothing out the inductive reactance component of the spark coil, allowing the energy stored in the inductance of the secondary to dissipate uninterruptedly through the gap.

Nor did suppressors at the distributor outlets in addition to those at the spark plug have apparent effect on engine starting ability. Shielding on the ignition cables with suppressors in the spark plugs indeed appeared to further improve starting.

Signal Corps engineers therefore conclude that based on the results of these tests on a typical military vehicle engine, and on oscillographic studies made independently on other engines, the effect of resistor-suppressors, if any, on extreme low-temperature starting of such engines should, if anything, bring about improvement.

- END -

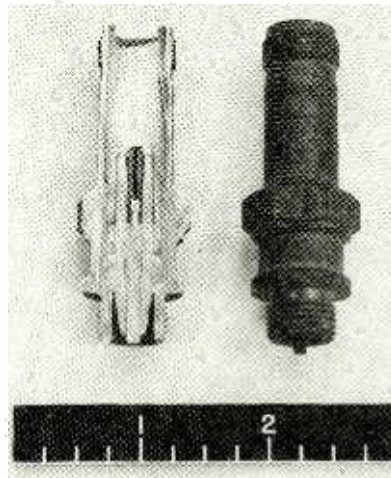

Photo of a resistor-suppressor spark plug used in the Army's sub-zero tests.

Fundamentals of Radio Servicing

Part XXVI—Servicing Techniques

By JOHN T. FRYE

“SERVICE technique” is the hoity-toity phrase used to describe something that is as essential to a service technician as a skimpy bathing suit is to a beauty contestant. The service technician may be the best brain in the business, and he may have the most completely equipped shop in these United States; but unless he can actually put those brains and that equipment to work servicing radios speedily and well, he is not going to offer much competition to the other boys in the game. In the words of the song: “It’s what you do with what you got that counts”; and what-you-do-with-what-you-got is just another name for your service technique. It is the way you go about locating and repairing receiver faults.

Strictly speaking, the important part of the technique is the procedure employed in trouble-shooting, for locating the trouble is by far the most important work that the technician performs. It is the part of his job that requires the most time, training, and equipment, the part for which the major portion of the service charge is really made. Actual repairing is usually simply a matter of snipping out a defective part and soldering in a new one; but even the best of technicians will occasionally sweat blood determining just which of the vast number of parts in a large receiver needs this replacement treatment.

Trouble-shooting methods

Down through the years several different systems of trouble-shooting have enjoyed popular favor. Each of these systems is important enough so that every technician should thoroughly understand and be able to practice all of them.

“Voltage measurement” is probably the long-time favorite system with most radiomen. It is based on the assumption that most troubles that afflict a radio—such as open resistors or coils and shorted capacitors—cause changes to occur in the voltages applied to the various tube elements. If the voltages present at the tube sockets are carefully checked against the voltages that *should* be there, any discrepancy will point the finger of guilt directly at the defective part.

Take the example of the single-tube

output stage diagrammed in Fig. 1. All voltages are measured with respect to the ground. A positive voltage on the grid would indicate that C1 was partially shorted or leaky. No voltage on the plate would mean that C2 was shorted or the primary of T1 was open. No voltage on either the plate or screen would mean that C4 was shorted or that there was some trouble in the B-plus supply. If the cathode voltage is exceptionally high, R3 must be open; if too low, C3 is probably shorted, etc.

One trouble with this system is that the user must know what voltages should be present on each tube element. A general idea may be obtained from

Many readers have inquired about obtaining this series in book form. We are glad to announce that it will be published by RADIO-ELECTRONICS under the title of "Basic Radio Course," Gernsback Library No. 44. It should be available in parts stores in mid-April

the recommended voltages given in a tube manual; but a much better source of this information is a voltage chart prepared either by the manufacturer or by the publisher of service manuals. Of course, after years of experience, the technician learns to know what voltages may be reasonably expected at the tube sockets of simple receivers; but even the experienced technician prefers to work from a service manual in performing his voltage measurements.

Another objection to the voltage measuring system is that the set must be turned on while the checks are made. That means that if there is a serious short in the receiver, some component may be overheating during this time.

“Resistance measurement” overcomes this last objection, for it can be carried on while the set is unplugged from the line. It assumes that most radio troubles upset the resistance values normal-

ly present between each socket lug and the ground or from one socket lug to another. For example, referring again to Fig. 1, if C1 is shorted, an ohmmeter will quickly reveal it when a check is made from the plate of V1 to the grid of V2. A very low resistance from plate to ground means that C2 is shorted; and a zero resistance from screen to ground indicates that C4 is ditto. Infinite resistance between plate and screen points to the primary of T1 being open. A resistance check from cathode to ground will instantly show if R3 is open or if C3 is shorted.

Service manuals indicate the normal resistance from each tube pin to ground in the same way that they give the proper voltage at each socket connection. The service manual is even more important in resistance measurement than it is in voltage measurement, because the tube manual cannot help here. Both of these methods fall down completely when it comes to showing up such defects as “open” capacitors that produce no changes in resistance or voltage.

One of the oldest methods of trouble-shooting is now dignified by the name of “circuit disturbance testing.” We used to call it simply “touching the grid caps or pulling the tubes.” In this system the grids of the tubes were touched with a metallic object, such as a screwdriver blade, or a tube was pulled from its socket while the radio was turned on. If the portion of the receiver between that particular tube and the speaker was functioning normally, a loud “click” would be heard whenever the plate circuit was broken by remov-

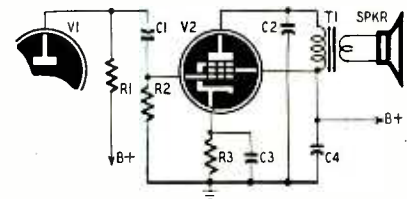

Fig. 1—A single-tube output circuit.

ing the tube; or, if the tube was amplifying normally, by the surge sent through the tube by disturbing the grid circuit. By starting at the output stage and proceeding toward the antenna end of the set and noting at just which

stage no click could be heard, a fairly good idea was obtained as to where the trouble was. The voltage measurement or the resistance measurement system could be brought into play to pin-point the defect.

While this method is fast and simple and requires no extra equipment, it has a number of disadvantages. For one thing, most modern tubes are of the single-ended type with the grids beneath the chassis; and it is much more difficult to reach them there than it was when they were at the top of the tube. Then, too, the system is not very practical with a.c.-d.c. sets that have all of the tube filaments connected in series. Removing any tube in such a set will usually cause a click in the speaker, since removing a tube is equivalent to turning off the set. Another disadvantage is that this method gives only a very rough idea of where the trouble is. You still have to use another method to run down the defective part.

An improvement on the rather crude circuit disturbance method is the "signal injection" system. In this procedure, a signal of the proper nature is placed upon each grid, starting at the output stage and moving toward the front of the receiver. For example, a 400-cycle note from a signal generator is used on the grids of the audio stages, the i.f. frequency is used on the intermediate stages, and the frequency to which the receiver is tuned is presented to the r.f. and mixer grids.

By noting just where the signal ceases to pass through the set or where it becomes distorted, the operator can determine rather closely where the trouble is lurking. Again, though, the final finger-pointing has to be performed by the voltmeter or ohmmeter. However, this system would have revealed if C1 of Fig. 1 was open. In that case, when the signal generator was placed on the grid side of the capacitor, the signal would have gone on through to the speaker; but when it was placed on the plate side, no signal would have been heard.

A newer method

The most recent method to enjoy popular favor is the "signal tracing" system. This method uses some form of detector—vacuum tube or crystal—mounted in the end of a probe which is connected to a high-gain audio amplifier. When this probe is touched to a point at which there is even a small amount of modulated r.f. energy, the modulation is detected and can be heard in the speaker of the signal-tracer amplifier. Provision is made so that plain audio frequencies can also be picked up by the probe.

The usual procedure in using the signal tracer is to feed a fairly strong modulated signal into the antenna of a receiver, either from a signal generator or from a strong local broadcast station, and then to trace the passage of this signal, step by step, down through the receiver until it suddenly disappears. By touching the probe first to the grid and then to the plate of a particular stage, not only will the presence or absence of the signal be noted, but also the actual amplification of the tube is revealed, both by the increase in signal as heard in the speaker and by the indication on a signal-strength meter that is built into many of the signal tracers. Furthermore, any noise or distortion originating in that particular stage instantly shows up.

While this system requires a special instrument, the writer strongly favors its use, especially by the beginning service technician. After you are experienced, you will be able, nine times out of ten, to make a very shrewd guess as to what is wrong with a receiver simply by listening to it; and then you can quickly double-check your suspicions by making only a few voltage or resistance checks. Until you get this experience, though, about all you can do with either of the first two methods discussed is to go doggedly through the set, measuring every socket connection until you find something wrong. That is a discouraging and time-consuming business. It is much better to use a

signal tracer to point out the particular stage in which the trouble starts and then use your voltmeter or ohmmeter to close in on the actual culprit. Even after you become a hot-shot technician, you will still find your signal tracer indispensable for running down noise, clearing up distortion, etc.

Use all methods

The good technician should regard trouble-shooting systems in the same way a gay bachelor feels about his feminine friends: he is familiar with all, but married to none. Any one of the systems, if followed persistently and exclusively, in the end will usually turn up a receiver fault; but the same thing can be done much more quickly and easily by using first one system and then another as convenience and the information at hand would seem to indicate.

Let us take a single example: Suppose you are using signal tracing and have followed the signal right up to the grid of the output tube of Fig. 1 but do not hear any signal at the plate. Next you check the plate voltage and find there is none. This could be caused by either a shorted C2 or an open primary of T1; so next you check the resistance from plate to ground. If C2 is at fault, this resistance will be zero. If the primary is bad, the resistance shown will be infinite. In the latter event, a final "clincher" check can be made from plate to screen.

Had you stuck to voltage or resistance measurement exclusively, you might have checked every other socket connection in the set before finally stumbling on the plate of the output tube; but by using the signal tracer you were able to narrow your search down to this one stage in a few seconds. Then, by resorting to the other two trouble-shooting methods, you were able to decide, by making only two or three measurements, exactly what part needed replacing.

That is good servicing, for every measurement was made with a definite purpose in mind and was the direct outgrowth of a previous test. A good technician does little haphazard measuring. He realizes that the real trouble-shooting is actually done in the mind, and he uses his instruments merely to feed information and clues to his intellect. Instead of dabbing his test prods here and there without rhyme or reason, he spends a lot of time studying the circuit diagram, trying to match the symptoms exhibited by the receiver to possible component failures; and then he uses his instruments to prove or disprove his studied guesses as to likely causes of the difficulty.

I confess it seems a dirty trick that now I tell you that you have to think to fix radios; but I was afraid that if I admitted this discouraging fact right in the beginning, before you learned how painless thinking can be when it is mixed with a little fun, you would quit me cold. However, now that you have waded through everything from Ohm's

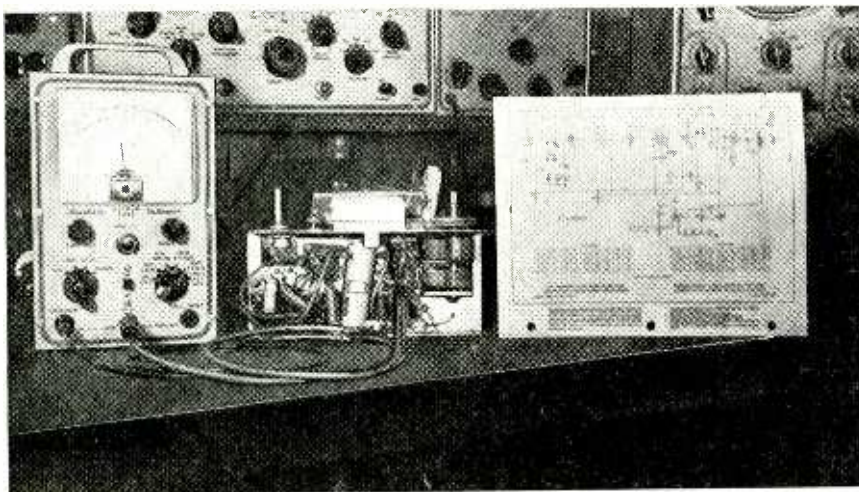

The voltage measurement system at work. Readings obtained on the v.t.v.m. are compared with the normal values which are given in the service manual sheet.

Fence Controller Repair

By JOHN W. COOK

law to the theory of pentagrid converters, I have not the slightest hesitation in divulging that you will need more brains than solder in service work. If you didn't have those brains, you would never have stuck with this series until the end.

In conclusion, I want to thank all of you who have written me during the publishing of the series. Especially appreciated were the letters from those of you who said that there were many phases of radio that you never really understood until you saw those things explained in "Fundamentals of Radio Servicing."

Those letters lead me to hope that the chief aim of this series has been realized: to explain the basic principles of radio in the down-to-earth language that we ordinary fellows use and understand. While I have done my best to keep the promise that you were to become thoroughly acquainted with the appearance, function, and weaknesses of every component normally found in a radio receiver, the presentation of this material has been deliberately casual and not too serious in tone. The writer has always held with Lin Yutang that, "Seriousness, after all, is only a sign of effort, and effort is a sign of imperfect mastery."

Finally, if you have had one-tenth as much pleasure in reading the series as I have had in writing them, I am more than satisfied!

- END -

SIMPLE SUPER ALIGNMENT

A superheterodyne receiver can be aligned without a signal generator if an accurately aligned receiver having the same intermediate frequency is available.

The receiver which is working properly supplies the test signals. Connect a small capacitor (.001 μ f or less) to the plate pin of its last i.f. stage, tune in a strong signal, and then turn down the volume. Feed the signal through the capacitor to the plate of the last i.f. stage in the set to be aligned, and adjust the i.f. trimmers for maximum output. Move the test signal to the plate of the first i.f. stage then to the plate of the mixer, peaking the trimmers on each of the transformers in turn.

Set the dial of the defective receiver to 600 kc. With both sets standing close together, adjust the oscillator trimmers on the defective set until its signal comes in at 1055 kc on the good set—assuming 455-kc i.f.'s. If you cannot pick up the oscillator on the good set, extend the antenna lead and lay it near the oscillator coil on the receiver being serviced.

Turn off the good receiver. Tune in a weak station near the high-frequency end of the band and adjust the r.f. trimmers for maximum signal from that station. Now touch up the i.f. trimmers. This is necessary because the coupling capacitor has a slight detuning effect on the plate circuits.—

Russell Libke

SERVICING electrical and electronic fence controllers can be an added source of income for the radio service technician. Many controllers are returned to the factories for repairs instead of to local radio repair shops. Visit the local farm co-operative and hardware stores that handle fence controllers and ask them about their repair work.

Servicing these controllers is similar to radio work. Fig. 1 is a wiring diagram of the Unico Deluxe Electronic Fence Controller, manufactured by the Guart-It Co., Chicago, Ill. This circuit resembles a conventional radio power supply with a trigger tube and pulse transformer added.

Follow the usual procedure of checking tubes, line cord, fuses, and capacitor when servicing this controller. Defective F385 tubes, open high-voltage secondary on the power transformer, and a cold-soldered connection between the two 45,000-ohm resistors are some of the troubles found so far.

The F385 tube is a mercury-vapor trigger tube. The standard 80 rectifier tube converts the high voltage a.c. to a pulsating d.c. which builds up a charge on the 3.75- μ f capacitor. When this charge equals the firing voltage of the F385, this tube conducts, and the capacitor discharges through the primary of the impulse transformer to ground. This rapid pulse of current causes a very high voltage to appear across the output winding of the transformer. The value of the two 45,000-ohm resistors determines the rate of the pulses. With the standard 90,000 ohms total resistance in the circuit, it puts out about 55 pulses per minute. Lowering this resistance would speed up the rate of pulses.

The Shox-Stok Controller uses a combination charging capacitor and vibrator-transformer setup to produce the high voltage pulses from a 6-volt dry or storage battery. Field servicing this unit is limited to checking the battery, capacitor, and wires, as the vibrator contacts and transformer windings are riveted inside the transformer shell. The manufacturer, Guaranteed Products, Inc., Wellington, Ohio, recommends that any further servicing be done at the factory.

The Unico Standard Controller uses a 6-volt hot-spark dry battery for power and uses a No. F340 factory-sealed enclosure which houses the charging capacitor and vibrator. See Fig. 2. To service, check battery, switch, and wires. Tap the F340 container to unseat any dirt particle that may have gotten in the contact points of the vibrator. An NE-51 neon bulb indicates proper operation by flashing each time an

impulse is delivered. Used 24 hours a day every day, the 6-volt battery should last three to four months.

To test a controller for normal operation, connect a well-insulated test lead to the high-output terminal and hold the other end about one-eighth inch from the ground terminal. A sharp, blue spark should jump this gap. Commer-

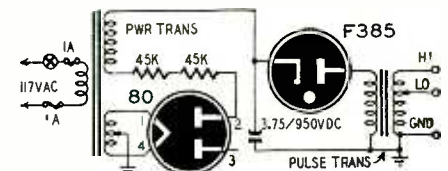

Fig. 1—Schematic of the Unico Deluxe electric fence controller. Pulse rate of the output is about 55 per minute.

cial testers are available also at low cost.

If you run across a controller that puts out a healthy spark when you hook it up, let it stay plugged in for a while and check it again. The charging capacitor, or a tube may show up a defect after it warms up. If the controller continues to work normally after a couple of hours of operation, check the owner's lightning arrester which should be with every electric fence installation. Also have the owner check his fence wire for breaks, extremely rusty connections, or shorts to ground

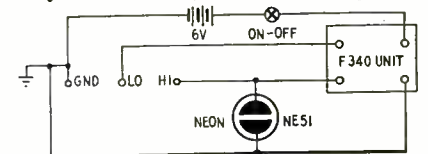

Fig. 2—Diagram of the Unico Standard. The F340 unit, sealed at the factory, houses vibrator and charging capacitor.

due to defective insulators or green weeds touching the fence wire.

If the controller is used outside, make sure any new components that are installed are properly sealed against moisture by melting sealing wax over them.

If r.f. interference is caused by a controller, check all connections in the controller and along the fence itself to make sure they are clean and tight. Do not connect the controller to the same ground wire that a radio is using. Outside radio antennas should be at right angles to the nearest strand of electric fence to minimize noise pickup from it.

The usual precaution of determining whether a controller is still within its warranty period before starting repairs is especially desirable because some controllers carry an insurance policy which protects the owner against injuries to livestock.

- END -

A Practical Synchrodyne

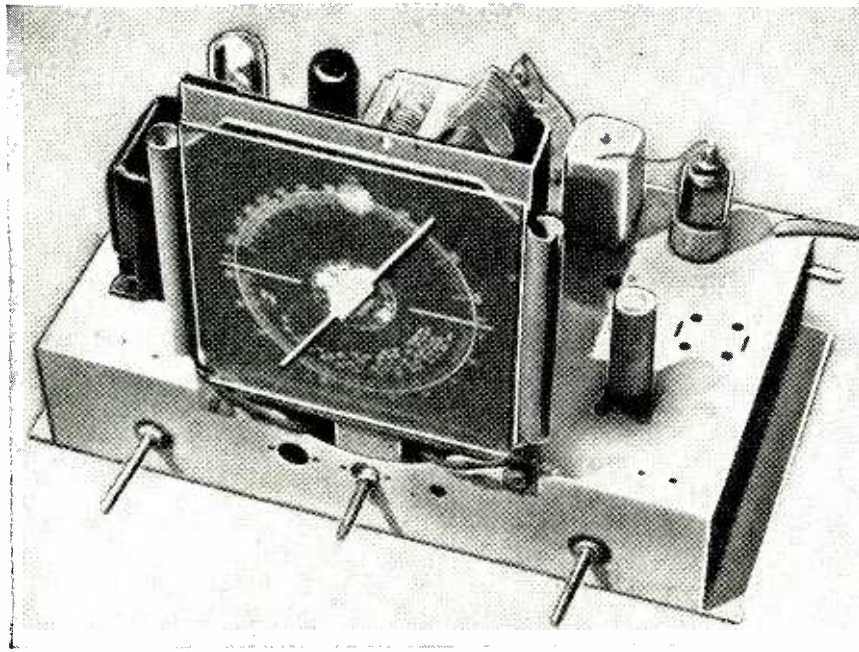

The completed synchrodyne receiver. It uses only four tubes, is easy to build.

THREE types of circuits have had much greater success in radio receiver design than any others. These are the regenerative detector, tuned radio-frequency and superheterodyne circuits. Now from England comes another circuit—a kind of *homodyne* in which (as in the regenerative detector!), the received signal is combined with one of the same frequency before detection. To avoid whistles and squeals, the extra signal has its frequency made *exactly* that of the received signal (even if the set is slightly off-tune), the matching of frequencies giving the name *synchrodyne* to the circuit.

Some proponents of the new circuit claim it is possible to build a receiver of extreme selectivity and still retain full "side-band quality," so we decided to see what could be done. We selected the simplest synchrodyne circuit of those available (described in *Electronic Engineering*, London, England September, 1947). We uttered a gasp of dismay at finding none of the tubes specified available in Australia (see Fig. 1), and looked up substitutes. The circuit called for a triode-hexode to act as oscillator and detector, so we thought a 6J8-G might do the trick. It did.

No special coil was available so we tried a Reinartz coil, neglecting the aerial connection. *Note*: Don't try using a superhet oscillator coil here unless you want a short-wave band instead of the broadcast! Some antenna coils can

be used, or coils wound with 12 turns and 50 turns of No. 28 enamelled wire on a 1½-inch coil form should work. Space the two coils ¼ or ⅜ inch apart on the form. Both plate and grid coils are close-wound, of course.

The circuit worked in a way, but selectivity was not what we had been led to expect. Part of the trouble was cross-modulation in the first stage due to overloading, so we added a tuned input to the radio-frequency amplifier. Results were now fairly good but the selectivity was very good on weak stations while very poor on strong ones. This variation in selectivity was due to variation in the amount of synchronizing signal. Also there were whistles on the weaker stations.

We next applied automatic volume control to the r.f. stage and selectivity became the same or nearly so for all stations. The volume control was now in the audio-frequency section. A tuned circuit could have been used for coupling between the r.f. amplifier and detector, but this is an unnecessary complication because selectivity is very good without it.

Final tube lineup, as shown in Fig. 2, was 6B8-GT, 6J8-G, 6V6-GT, and a 6X5-GT. For the r.f. stage, we tried a more modern tube, the 6SF7, but results were just the same. For the output stage and for rectification, any standard tubes, such as the 6AQ5 and 5Y3-GT, could be used. Unfortunately no other synchrodyne tube could be used—we tried a 6A8-G and a 6K8-G but that was just wishful thinking and neither worked (except as a feeble plate detec-

This improved circuit from Australia combines extreme selectivity with excellent sideband quality retention

By JOHN W. STRAEDE*

tor). The output stage must be well designed as tone quality is largely determined here. A large speaker transformer and a large speaker with plenty of magnet are desirable. A separate audio amplifier can also be used.

We found tone quality excellent, although the circuit we started with was only the simplest synchrodyne circuit we could find. Later references, mostly in British magazines, gave data for coils, but our final set used a standard antenna coil and a t.r.f. with regeneration coil. In the latter the primary winding was neglected, the regeneration winding acting as the grid coil. An antenna coil, with its primary in the grid circuit, would probably work as well in the oscillator. The turns ratio, primary to secondary, should be about 1:3 or 1:4.

More elaborate synchrodyne circuits enabling better quality combine the two signals by means of a bridge device such as is used in some beat-frequency audio oscillators and use diodes for detection.

Unfortunately the synchrodyne cannot remove interference in the form of 10 kc whistles caused by heterodyning of neighboring broadcast stations, so a kind of tone control was placed between the detector and output stage. This is really an audio-frequency bandwidth control, as it attenuates both the extreme highs and extreme lows

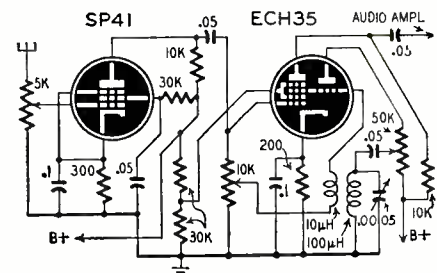
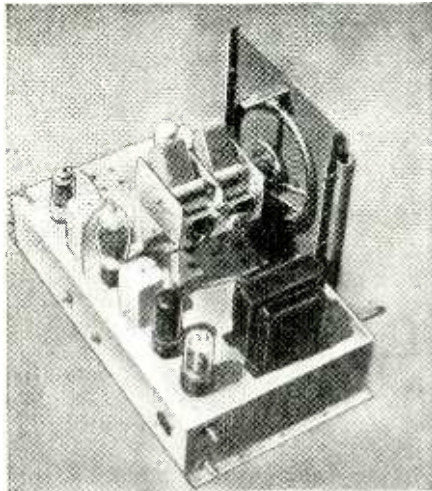

Fig. 1—One of the original synchrodynes, this circuit comes from England.

* Lecturer in electronics and electro-acoustics, Melbourne Technical College, Australia.



Another view of the set. Both sections of the tuning capacitor must be equal.

simultaneously to provide a balanced reception.

After building the receiver, the potentiometers for feedback and synchronization—located on the back of the chassis—are adjusted. The synchronizing control is set with its moving arm at the ground end, and the feedback control is adjusted until a whistle is heard on each of the local stations to be received. Then the synchronizing voltage is applied until the locals are without whistles. Too much

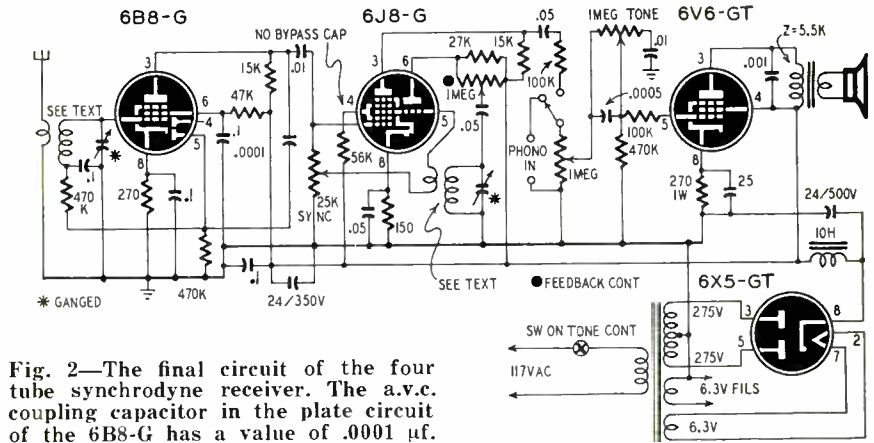

Fig. 2—The final circuit of the four tube synchrondyne receiver. The a.v.c. coupling capacitor in the plate circuit of the 6B8-G has a value of .0001 μf.

sync results in insufficient selectivity. So does too little regeneration. The input circuit may need to be aligned before finally adjusting the two potentiometers. Too much output should be avoided—only enough to drive the output stage on locals with the volume control set at maximum.

If a pickup is to be fitted, it should be of the high-output crystal type and connected as shown in the diagram.

One interesting feature of this circuit, from the experimenter's point of view, is that old t.r.f. receivers are easily converted to it, the number of large parts, such as coils and tubes, not being increased.

Materials for Synchrondyne

Resistors: 1—150; 1—270; 2—15,000; 1—27,000; 1—47,000; 1—56,000; 2—100,000; 3—470,000-ohm, 1/2-watt; 1—270-ohm, 1-watt; 1—25,000-ohm; 3—1-megohm potentiometers.

Capacitors: 1—.0001; 1—.0005-μf, mica; 1—.001; 2—.01; 3—.05; 4—0.1-μf, paper; 1—25-μf, 25-volt, 1—24-μf, 350-volt, 1—24-μf, 450-volt, electrolytic; 1—365-μuf, 2-gang, variable.

Miscellaneous: 1—broadcast antenna coil; 1—t.r.f. coil or antenna coil with turns ratio of about 3:1; 1—power transformer, 550 volts c.t. at 60 ma and two 6.3-volt windings; 1—output transformer, 5,500 ohms to voice coil; 1—10-h, 60-ma choke; 1—6B8-G, 1—6J8-G, 1—6V6-GT, 1—6X5-GT, tubes and sockets; switch on tone control, chassis, hookup wire, assorted hardware.

—END—

Compact Strobotron Pulsar

By R. L. IVES

EQUIPMENT for producing successive pulses of relatively short duration, at repetition frequencies from about one to about 200 times per second, is usually complex and wasteful of power. Most such pulsers consist of a relaxation oscillator, followed by an amplifier and pulse-shaper.

Because of this complexity, many such pulsers have been constructed on the general principle of the relay-capacitor oscillator¹; or with a higher-frequency oscillator followed by a sub-multiplier. All of these circuits suffer either from the need of very high standby power (mostly used in filament heating), proneness to contact trouble; or objectionable noise and vibration.

Filament standby power, as well as contact trouble and noise, can be eliminated by using cold-cathode gas-discharge tubes.

Experiments in the early 1930's, largely by Edgerton and Germeshausen², resulted in the development and commercial manufacture of the strobotron, a multi-element neon tube, containing a plate, a cathode, and two control grids. This is marketed as the Sylvania 1D21, or the General Radio 631P1. In this tube, the striking voltage between plate and cathode is rela-

tively high (about 300), whereas that between either control grid and cathode is much less (80 to 125). Plate and cathode are designed to carry high momentary currents; control grids are of lighter construction.

With a high voltage (up to 300) between plate and cathode, no discharge takes place. However, a glow discharge between any two elements (such as from either grid to cathode) causes an arc discharge from plate to cathode. Thus a medium voltage at very low current can trigger a higher voltage and very high current discharge. Also, the control grid and cathode can be arranged to work as a conventional neon oscillator at frequencies from less than 1 cycle per second to more than 250 cycles. This makes it possible to construct a relaxation oscillator and pulse shaper "all in one bottle," requiring no filament current, and few other components.

Fundamental Circuit

Complete circuit of a self-cycling strobotron pulser, including power supply, is shown in Fig. 1, with working constants. Power supply is a conventional "transformerless" voltage doubler. If circuit isolation is needed, a

small isolation transformer can be inserted at Y-Y. Smaller filter capacitors can be used here, but that makes the circuit sensitive to line frequency, so that it may "mode" or "slop" at sub-multiples of 60 cycles, producing interesting, peculiar, and undesired variations in pulse shape and frequency.

The relaxation oscillator consists of a conventional resistor-capacitor series from supply plus to supply minus, with the control grid of the strobotron connected to the capacitor-resistor junction. Working constants, giving the approximate frequency of oscillation can be found from:

$$f = \frac{1}{RC}$$

in which f = frequency in cycles per second,
 R = resistance in megohms,
 C = capacitance in microfarads.

Considerable variation was found from

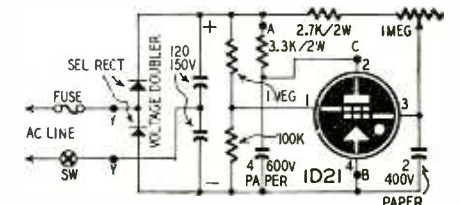

Fig. 1—The strobotron pulser circuit.

tube to tube, but this can be compensated for by varying the voltage on the shield grid (pin 1), which should be set at about 26 volts, when supply voltage is 300.

Pulses of high power are produced when the glow discharge between grid and cathode triggers a discharge between plate and cathode. This discharge consists of the stored power in the 4- μ f capacitor between plate and cathode. This capacitor recharges slowly from the power supply through a resistor of 3,300 ohms, or more.

Pulses can be taken off at a number of places in the circuit. When the load

controls that need be accessible are the off-on switch and the frequency-control knob.

To prevent damaging the strobtron through continuous discharge, a safety resistor of 2,700 ohms is connected in series with the 1-megohm frequency control resistor, which gives continuous variations of pulse repetition frequency from about 1 pulse each 2 seconds to about 300 pulses per second. A non-linear resistor, with resistance per division increasing upward, should be used here for smoothest control.

For convenience of access to various parts of the circuit, a 4-terminal plug

transformer in series at A (Fig. 1) as a power takeoff.

The self-cycling arrangement of the strobtron makes it suitable as a variable rate strobtron, for study of oscillating, reciprocating, and rotating machinery through a wide range of speeds. For this application, the tube may be connected to the chassis by an extension cord, and a light shield around most of the tube makes observations easier by eliminating glare.

By substituting a sense element, such as a thermistor, or a resistance humidity element, for the frequency control resistor, the pulser can be used to transmit intelligence, frequency of pulses being a function of the resistance of the sense element.

A pulser of this type can be operated from a small 300-volt B-battery. Where power output need not be large, the pulse capacitor (4 μ f in Fig. 1) can be reduced in capacitance without impairing other functions.

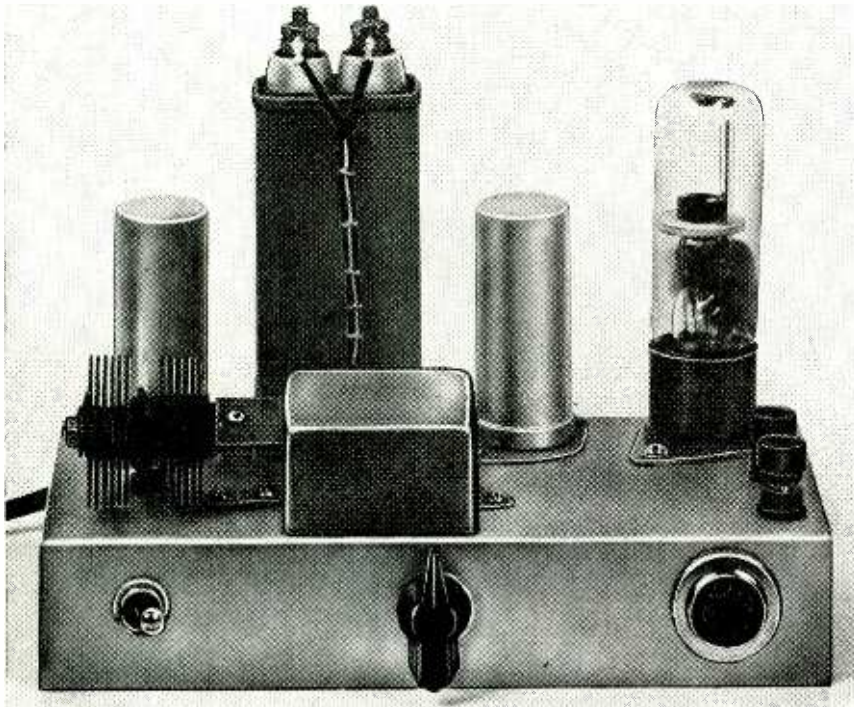

Photo of the self-cycling pulser. The strobtron need not be on the chassis.

is a low-impedance one, it can be inserted in series with the tube cathode, at B. Such insertion modifies the pulse form slightly. A high-impedance load can be connected in series with the charging resistor, at A. The pulse here is the recharge pulse of the capacitor, and lags slightly behind the discharge pulse through the tube. Similar pulses can be tapped off by capacitance coupling between A and C.

Pulses in phase with tube pulses are obtained by capacitive coupling from B to C. Various other connections can be made to tap off pulses. Some of these are independent; others tend to modify the pulse shape or duration.

Construction Features

Because there are no high-frequency circuits, the mechanical layout of a pulser of this type is not critical. Components can be arranged to suit space requirements without impairing operation in any way. For laboratory use as a "work-horse" instrument, assembly on a standard 1½ x 4 x 8-inch 4-hole pre-punched chassis, as in the photo, is convenient and inexpensive. The only

is wired in shunt with the tube socket, and a pair of binding posts is provided for a tap-out in series with the charging resistor. This is normally shorted by a length of wire. The wiring beneath the chassis, which is quite simple, is purposely not cabled, to facilitate tapping in to various parts of the circuit.

Applications

This pulser was originally designed for destruction testing of meteorological relays and counters, to replace a relay oscillator. It not only worked better and more economically than the relay device, but also could be easily modified to do almost everything a relay-capacitor device can do, and do it with less noise, less initial cost, less power consumption, more dependability, and less "down time".

Other practical applications of this pulser are as an electrical metronome, using a 5,000-ohm relay in place of the 3,300-ohm charging resistor for the 4- μ f pulse capacitor as a sounder; as a stepper for mechanical computers; and as an electrical stimulator for psychology laboratory animals, using a small

References
 1 **The Relay Oscillator and Related Devices** R. L. Ives, *Journal of the Franklin Institute*, vol. 242, 1946, pages 243-279
 2 **The Strobtron**, E. J. Germeshausen and H. E. Edgerton, *Electronics*, February, 1937, page 12.

- Materials for pulser**
Resistors: 1—2,700, 1—3,300-ohm, 2-watt; 1—100,000-ohm, 1—1-megohm, ½-watt; 1—1-megohm, potentiometer.
Capacitors: 1—2- μ f, 400-volt, paper; 1—4- μ f, 600-volt, paper; 2—120- μ f, 150-volt, electrolytic.
Miscellaneous: 2—selenium rectifiers, 100-ma; 1—socket, 4-prong; 1—1D21 Strobtron tube, fuse, fuse holder assembly, switch, binding posts, hookup wire.

—END—

—TONE-OPERATED RELAY

Tones between 20 and 10,000 cycles are often transmitted by wire or radio and used to open or close relays at the receiving station. A supersensitive relay designed for operating from the headphone output of a receiver or from telephone lines is shown in the diagram. The relay armature pulls in when the signal input to the amplifier is approximately 50 millivolts at 1 microwatt. The 6SJ7 and 6V6 amplify the signal. The 1N34's are connected as a full-wave rectifier to convert the signal to d.c. for operating the relay.

This circuit, printed through courtesy of Cornell-Dubilier Electric Corp., uses a Staco type MR-5 relay. If this type is not available, others of equal sensitivity may be tried. R1 and R2 are

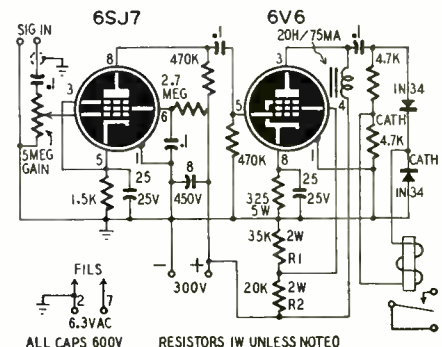

ALL CAPS 600V RESISTORS 1W UNLESS NOTED
 not preferred values, but their exact values may be obtained by selecting them from 33,000- and 22,000-ohm 10% resistors.

—END—

A.C. Supply for Mobile Use

Operating from a 6-volt battery, this vibrator type supply furnishes 35 watts at 110 volts, 60 cycles

By PAUL W. STREETER

THIS power supply unit was originally designed to furnish a 110-volt, 60-cycle alternating current to operate a tube tester in localities where a.c. is not available. Later the same unit was converted to operate an automatic record changer for use in a car with a public address amplifier. Several commercial units are available which can be used on a car battery to obtain alternating current, but their cost is high and their power ratings are usually too high for the requirements. Also, the input current of these units, even at low power output, is higher than deemed necessary for our use.

One of the most trying problems in designing such a power unit is selection of a proper vibrator and transformer. Of course, if 60-cycle current is to be obtained, a 60-cycle vibrator must be used. Also, any power at 110 volts output will be reflected as equal power at the input, plus losses at the vibrator points, in the transformer, and losses in the high-current, low-voltage wiring. Wiring losses can be kept low with

if we could keep the output load down, a 60-cycle transformer would serve the purpose.

The final result for two vibrator types is shown in Fig. 1. We find it possible to obtain 30 watts of 110-volt a.c. output with 9 amperes input from a 6-volt storage battery, which is ample for our requirements, although we have obtained as high as 35 watts. Since we wanted to operate a phonograph motor, we had to get exactly 60 cycles in the output, as these motors are synchronous motors and must run on exactly 60 cycles to maintain proper turntable speed. A variation of only one or two cycles impairs reproduction.

Several types of surplus vibrators, and two types of standard commercial vibrators fortunately are available for use (such as Cornell-Dubilier's No. 490 and 491), that have 60 cycle reeds. Other parts needed were salvaged from the scrap-box, with the exception of three pieces of tin which cost us 35¢. Total outlay for the entire unit, including vibrator, was less than \$4.

The transformer was salvaged from an old trade-in radio. Originally, it furnished filament and plate current for a 7-tube set, and the radio required about 50 watts at 110 volts. Any similar 50- or 60-watt transformer will be satisfactory, if there is room for the 11.2-volt center-tapped winding that must be added after the other unused windings are removed and discarded. This added winding is the primary winding of the revamped transformer.

First remove the transformer's cover plates and iron core and lay them aside. Unwind the outside winding, counting the turns-per-volt of the original design. We found 36 turns in this winding. Since we knew the winding originally delivered 6.3 volts for tube filaments, it was easy to determine that the turns-per-volt was 5.7.

Remove and discard all other windings except the 110-volt primary (the inside winding). The primary winding becomes the secondary in the revamped transformer. On top of the remaining winding, install a winding equivalent to 11.2 volts center-tapped (in our case 64 turns of No. 12 enamelled wire, with a center-tap at the 32nd turn). Bring out leads and cover the outside of the windings with heavy paper; then reinstall the iron core with the core pieces assembled in their original order.

Dip the reassembled transformer, less the enclosing cover plates, in transformer varnish and bake it in a slow oven at 275° for two hours. If no oven is available, the transformer can be air-dried. After cooking or drying, bolt the end covers on and the transformer is ready to be installed.

There isn't much to assembling the power unit, once the transformer is altered. All 6-volt leads should be of No. 12 or heavier wire. The schematic is self-explanatory. Layout is not critical, as long as the vibrator can be installed in the proper position, either vertically or horizontally. The entire assembly may be mounted in the base of a record changer, although we have ours under the dash of the car with the record changer placed so that it will plug in, and the power unit 6-volt leads are permanently connected to the car chassis and the battery side of the starter switch. If the power unit is mounted under the record changer mechanism, it may be best to have a floating socket for the vibrator, to eliminate vibrations from reaching the phonograph pick-up arm.

Additional filtering is needed to use this power unit for a small radio (especially a.c.-d.c. sets) due to "hash" in the output. However, the unit can deliver up to 35 watts of 60-cycle a.c. for any other use, for hours on end.

Many other uses suggest themselves. We have used the unit to power electric razors, radio test gear, and a variety of other equipment. Because of its small size, it is especially useful for car operation, where it can be mounted under the dash and out of sight. It has good efficiency and does not put too much power drain on the battery.

If 35 watts is not sufficient for any particular use, the unit can be built to handle more power by using a proportionally larger transformer. The re-winding method would be exactly the same, but it may be necessary to use a larger wire size, both in the transformer and in the low-voltage, high-current circuits.

Materials for Converter

Resistors: 1—220 ohms, 1/2 watt; 1—2,000 ohms, 10 watts.

Capacitors: 1—.01, 1—.05 μ f, 200 volts; 1—.01 μ f, 1,000 volts.

Miscellaneous: 1—transformer (see text); 1—14-amp fuse and holder; 1—s.p.s.t. 20-amp toggle switch; 1—60-cycle vibrator (see text); 1—a.c. receptacle; chassis, hookup wire, assorted hardware.

— END —

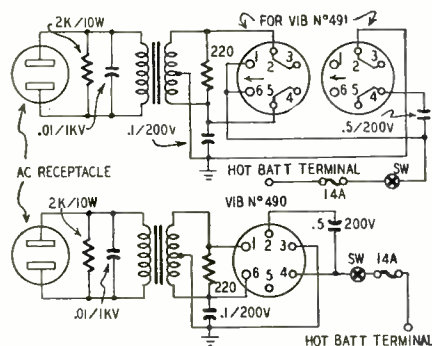

Fig. 1—Two versions of the converter. One is intended for a C-D vibrator No. 490, the other for No. 491. Any similar 60-cycle, 6-volt vibrator can be used.

heavy leads. Since the transformer in this case depends upon the vibrator to reverse the flow of d.c. through it at a rapid rate, it also means that the transformer core can become saturated if that d.c. hangs around too long before each reversal, with heat and high current resulting in the transformer primary.

We decided that a 25-cycle transformer with a husky core would be the answer, but we didn't have one available. Finally, we tried a 60-cycle transformer under reduced input current, with gratifying results; and found that

Tristimulus Color Photometer

By ERIC LESLIE

New instrument specifies accurately color components from any source minus the involved computation formerly needed for color specification

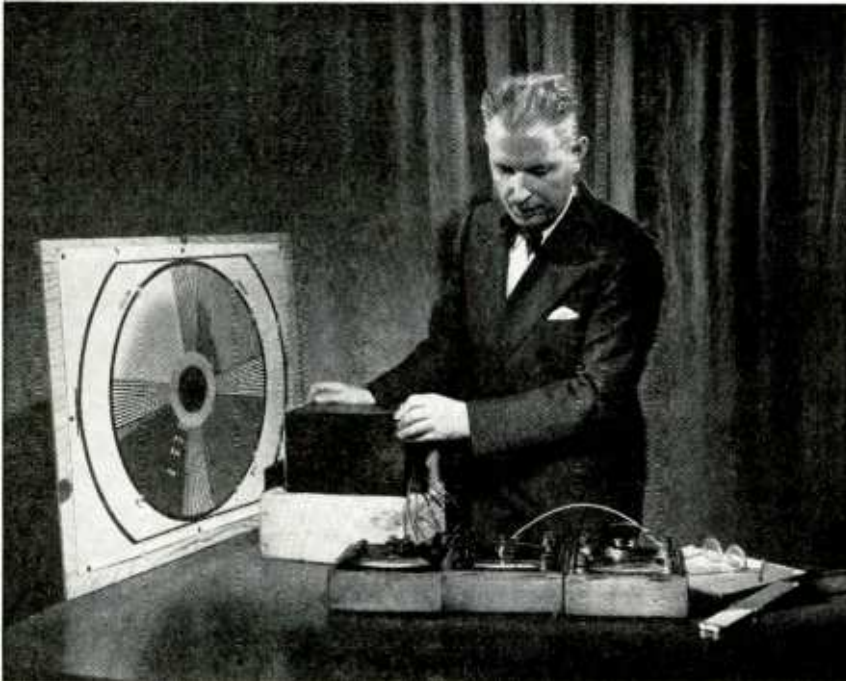

Physicist Geo. C. Sziklai of the RCA Laboratories demonstrates the photometer. The meter itself is mounted on a block pointing at the subject, a color test pattern in this case. Values are read from the three microammeters at right.

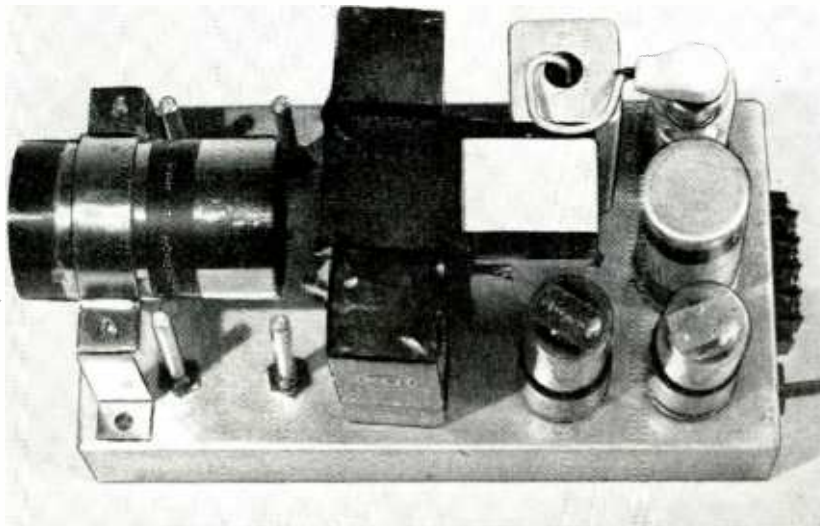

The photometer with case removed. Lens is at left, with the crossed mirrors boxed just to its right. The photocells are to the sides of and behind the mirrors.

WE RADIO-ELECTRONIC technicians have learned more about color in the past few months than we ever learned in our lives before. More important, we are conscious of our ignorance on the subject. To some of us the apparently opposing red-green-blue and red-yellow-cyan are as incompatible as the aims of CBS and RCA. Once we have the additive red-green-blue system in our heads, we learn that a color can be changed by turning one of the color-channel gain controls up or down a little. We find also that the primaries which produce all the colors do not exist as such in nature and that by properly mixing primaries picked at somewhat different points along the color spectrum we can match any color in a televised scene almost perfectly. What seems to be a simple problem of mixing three fixed primaries at the correct intensities to produce or match a given color becomes a very complex problem in which the given color can be matched by an almost infinite number of combinations of primary-intensity components.

The lighting engineers had all these problems years ago. They had to do something about color, and they devised a system of color *specification*, sufficiently accurate so that two colored objects or lights can be matched from the specifications, without actual comparison. This is particularly useful in the commercial world. Colored materials can be ordered according to specification, rather than by inexact color names. The importer was relieved (at least partially) from trying to distinguish between Saxon, Belgian and Copenhagen blue, and the business firm found it simpler to obtain successive printings of its letterheads or other stationery on exactly the same color stock. The printing and paint industries, among others, were also greatly benefited by the adoption of a standard system of color specification.

Color Specification

The method is called the *tristimulus system*. Like television color, it depends on the relative strengths of three components, \bar{x} , \bar{y} , and \bar{z} . They share the visible spectrum much as do the components of color television. See Fig. 1. The \bar{x} component peaks near 6,000 Angstroms, in the red, the \bar{y} near 5,500 A (in the green) and the \bar{z} near 4,500 A (in the deep blue). These are the sensitivities required to reproduce any color with the standard primary colors. They were chosen so that the \bar{y} curve is identical with the visibility curve of a standard observer. This choice however specifies a minor lobe in the \bar{x} curve, far down in the blue.

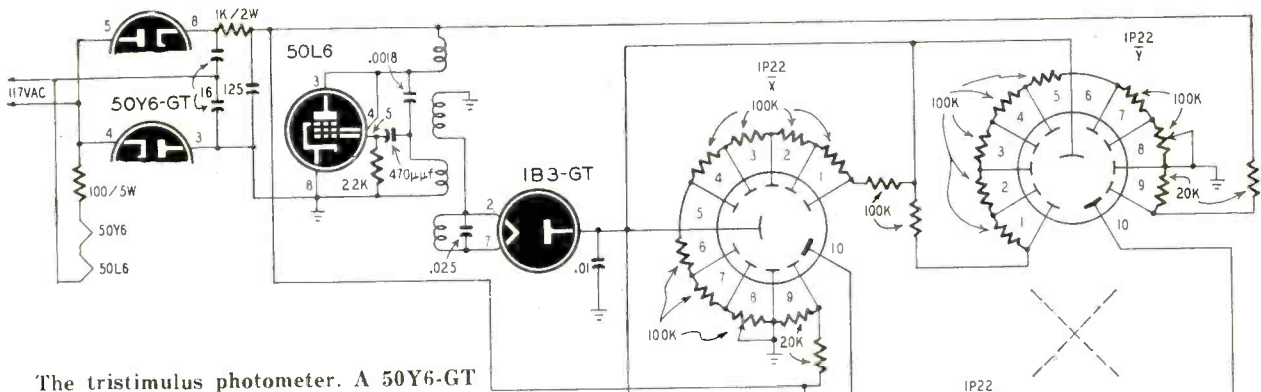

The tristimulus photometer. A 50Y6-GT in a voltage doubler circuit powers and supplements r.f. high-voltage supply.

The system was adopted in 1931 by the International Commission on Illumination and is therefore often referred to as the ICI system.

To specify a color (so that it can be reproduced or matched from the specifications), it is necessary to go through a complicated mathematical process, based on measurements of the light radiated or reflected from the subject, taken at a number of frequencies across the visible spectrum. As many as 30 points may be used for the specification, and the computations require calculus,

C5-3-113, C5-4-111, and C5-5-79 filters, produce \bar{x} , \bar{y} and \bar{z} response respectively. Because much less light reaches the \bar{x} phototube through its heavy filter, a more sensitive meter is used in its circuit (1 micro-ampere as against 10-micro-ampere ranges for the other two channels). The light is distributed to the three phototubes through a crossed semitransparent mirror. A 5-inch lens ahead of the mirror system focuses the light. The gain of each channel can be adjusted with the 100,000-ohm potentiometers, which are placed between two of the multiplier units of each photocell.

to it in the last multiplier stage, where the effect of any residual hum would be negligible.

- END -

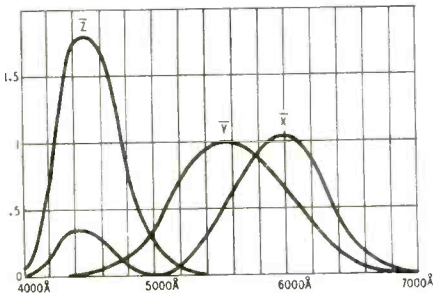

Fig. 1—How the three tristimulus components are distributed in the spectrum. The minor lobe of one of the curves was the problem which had to be overcome in designing an accurate color photometer.

and are time-consuming and tedious.

A number of instruments designed to measure color directly have been developed, but their accuracy is limited. It would seem quite possible to approximate the three curves of the tristimulus system with three photocells and appropriate filters. In practice this is not easy, particularly with the double-looped \bar{x} curve.

An accurate instrument

To solve this problem, physicist Sziklai of the RCA Laboratories injected the idea that made possible an accurate and practical tristimulus meter. Since the minor lobe of the \bar{x} curve is almost under the \bar{z} curve, why not feed a little \bar{z} signal into the \bar{x} circuits and produce a synthetic \bar{x} response. The system worked and was realized in the circuit above. The 100,000-ohm variable resistor and 1N34 rectifier (to prevent back-flow) is the synthetic- \bar{x} circuit.

Three IP22 phototubes, with Corning

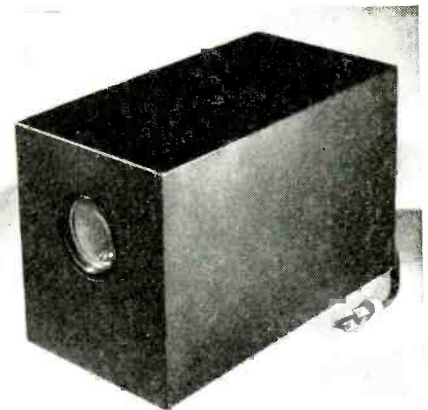

The complete instrument (minus meters).

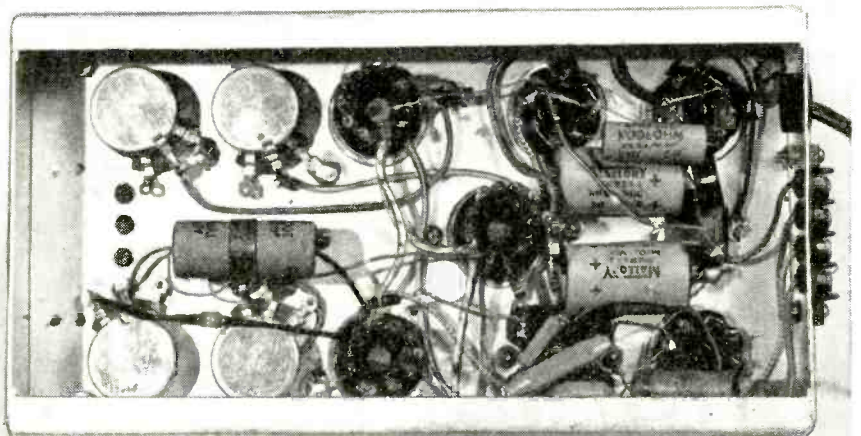

Underchassis view. The microammeters are connected to the strip at right of photo. Position of the phototubes can be seen in this photo. Their sockets are farthest left, next to the four potentiometers whose shafts are seen in photo, page 48.

Signal Corps Radio Training



GI's find many opportunities in the Army's Signal School

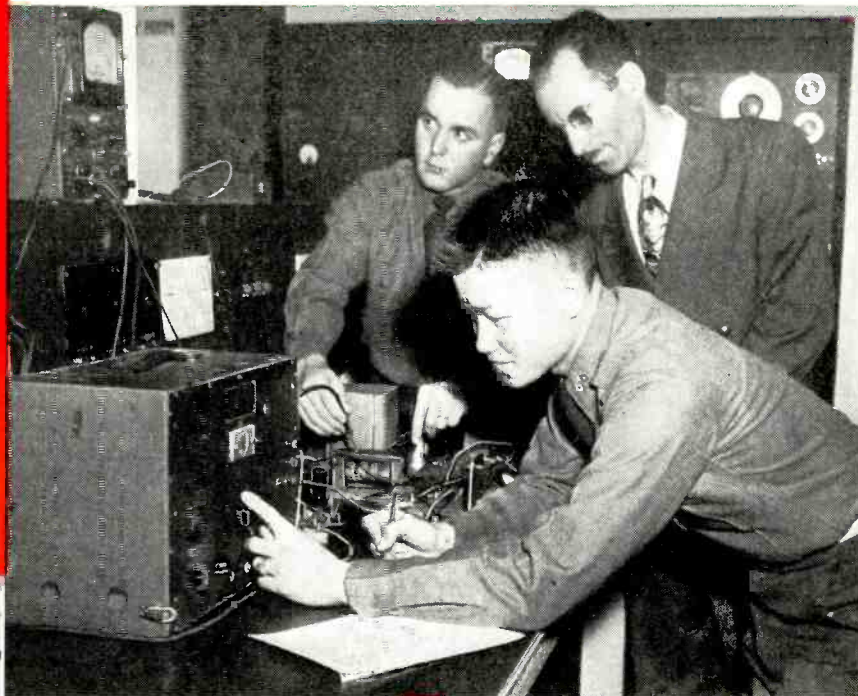

Two officer students learn the intricacies of radio from a civilian instructor. Men from all branches of the army attend the Signal School.

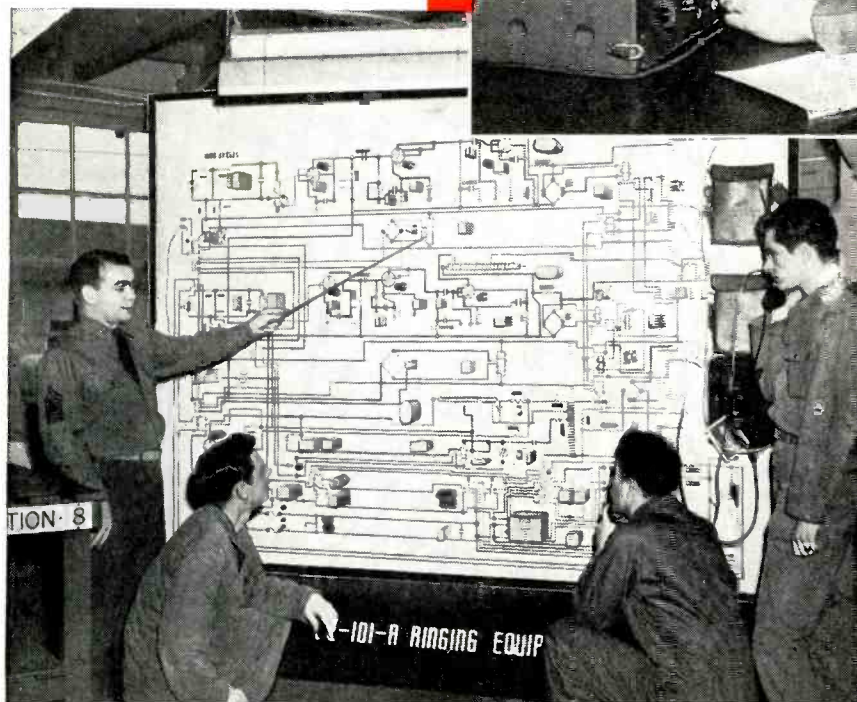

These students are studying the circuits of an EE-101-A Ringing Equipment unit. This is typical of the training aids used at the Fort Monmouth school.

THE serviceman who arrives at The Signal School, Fort Monmouth, New Jersey, soon realizes the broad scope of Signal Corps opportunities. He finds himself in a position to learn practically every phase of the particular branch of signal work he has chosen to follow.

Assignment to the Signal School is not a matter of chance. The student is selected for Signal Corps training and duty according to educational background, civilian experience, and adaptability as shown in classification tests given shortly after entering the Armed Forces. Civilian hobbies play a large

part in the selection of students for the Corps. A ham radio operator or a camera fan stands an excellent chance of becoming a Signal Corps trainee. Once assigned to the Signal School the extent of the student's training is usually limited only by his ambition and capabilities.

The Signal School is divided into Radio, Wire, and Photo Divisions, with a fourth, the Common Division, doing the work of a preparatory school for Radio and Wire Divisions. This first section instructs the student in basic electricity, alternating and direct current, and general shop work. He studies

simple radio circuits here, and is prepared to work on actual field equipment at the next stage of his progress. The Division is reminiscent of a good standard radio school, in which the emphasis is placed on practical work, and much use is made of the demonstration board.

Specialized types of boards are used in elementary teaching. One board, for example, has numerous pieces of radio equipment mounted on its surface. On a desk-like surface below the board are printed the names of each piece of equipment, with an electrical contact beside each name. At the other side of the desk are the symbols representing the same equipment, also with a contact for each item. The student is equipped with a pair of test prods, one of which he must place on the contact opposite the symbol, the other on that opposite the name of one of the components on the board. If he does so correctly, a light appears below the component. If not, a red light appears on the desk.

The Specialized divisions

Leaving the Common Division, the student goes to the AM Receiver Division, where he learns the workings of common military AM receiving equipment. Other divisions through which he must pass are AM Transmitters, FM Transmitters, and FM receivers. When

he has passed through all these groups he is capable of maintaining and repairing all common military radio communications equipment.

Meanwhile his fellow-students in the Common Division who have elected to study wire equipment are learning the specialized techniques of that branch of communications. They may be learning to climb poles, to operate teletype equipment, and how to operate and maintain facsimile apparatus.

The communications graduate may go further on to one of the specialized branches of communications, for example radar. This calls for further specialized training in the Radar Division. Another interesting section is the Radiation Branch, in which the student learns to service the various types of electronic equipment used to detect radiation. Instead of communications equipment, he learns to work with alpha-ray detectors, Geiger counters, and similar instruments.

Classroom progress of the student is limited only by his own ability. Within any course the "individual progression" method of instruction is employed, dif-

may become a central office technician or the student radio operator may go up the scale and qualify as a fixed-station radio repairman or a radar specialist. The equally ambitious photography student can go through the entire field of still and motion picture operations, camera repair, and laboratory techniques.

Inversely, the student who has trou-

him in the school. His record as a student plays a large part in his eventual duty assignment. There is nothing haphazard about the assignment of technically trained personnel. They are detailed to an organization and to duties in keeping with their military occupational specialties. There again the technician is limited only by his own ambition and ability. Under the Armed

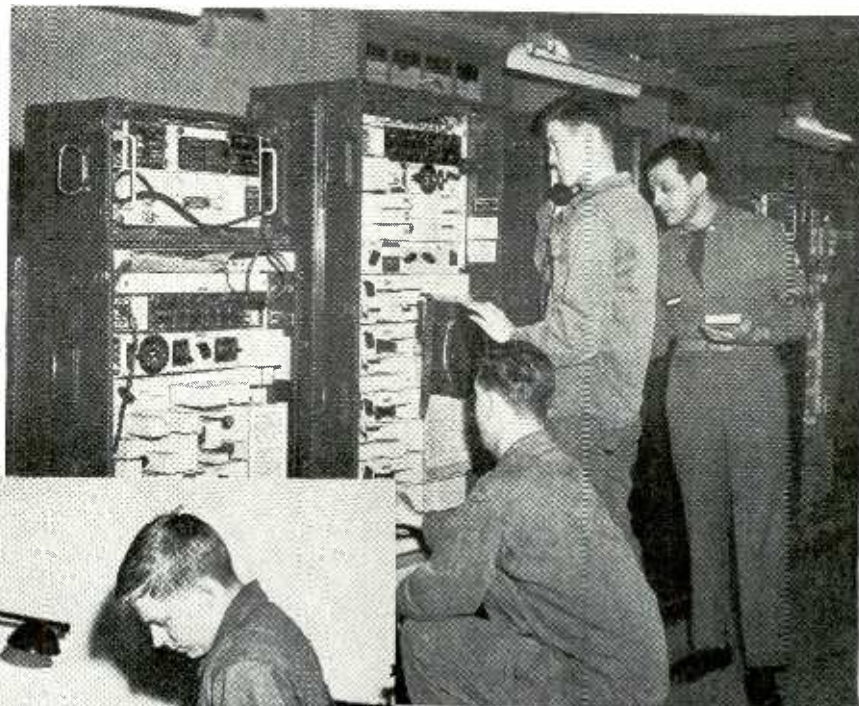

Wire division students learn to handle this field telephone carrier equipment.



Teletype equipment repair is among the many subjects that the GI's can learn.

fering completely from the group or class methods. Those students who absorb and retain instructions more rapidly than others are not held back. The individual is given a lesson to study, a certain amount of laboratory work to perform, and then an examination on that one lesson. After passing the examination he proceeds to the next lesson on the schedule. In case of failure, the student retakes the examination after further study.

Course Assignments

Assignment to a course does not limit the trainee to that particular course. If, after some schooling and testing, he shows the qualifications necessary for a higher level course than the one he is studying, he may be reclassified and moved up the training ladder. Thus the student cable splicer or lineman, by means of his own efforts, eventually

ble completing a course may be reclassified and assigned to the next lower echelon of training in the same field. After successfully passing that course he may again be considered for the more difficult subject.

This method of study and upgrading greatly enlarges the opportunities in the Signal Corps. Through it the ambitious student can learn practically all phases of his chosen field in a minimum of time. The value of these methods can hardly be figured in dollars and cents.

The only exception to the upgrading while in school is in the case of the soldier whose parent organization sends him to the Signal School to be trained for a specific job. In his case, he completes the designated course as rapidly as is consistent with thorough training and is then returned to his own unit.

Postgraduation opportunities for the student are as unlimited as these offered

Forces' career plans, he may, through his efficiency rating and grades scored in competitive tests, gain promotion and higher-level duties.

In addition to the opportunities offered in the field, the graduate of the Signal School may be—and quite often is—considered for duty with the school as a technical worker or instructor. Or, if qualified by reason of experience and schooling, he could be assigned to one of the engineering and research laboratories which are a part of the Fort Monmouth establishment. There he will find himself in the midst of research and development work of the highest caliber. Many of today's improved radio, television, and telephone designs and techniques are a direct result of the work accomplished by the Signal Corps Engineering Laboratories and cooperating private industries.

The opportunities and training offered by the Signal Corps are second to none in the country. Major General Spencer B. Akin, Chief Signal Officer, emphasizes this fact in a letter of welcome addressed to new student personnel, pointing out that the facilities offered the student are backed by the vast technical resources of the country and that his abilities are developed to the fullest by the challenge of the speed necessary to properly maintain the modern communications of the Corps.

—END—



Fig. 1—The hypnotron emanates a random series of signals, represented here by dots. Consecutive signals are never alike.

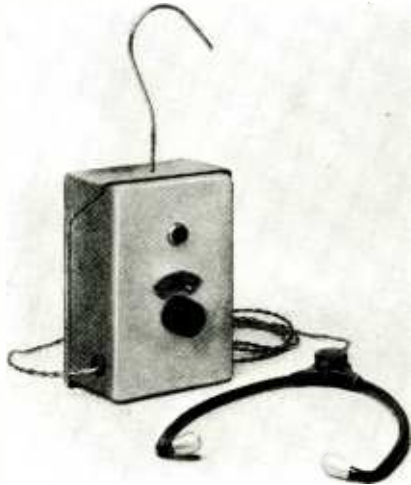

A small portable model of the hypnotron.

The Hypnotron

**A famed Soviet scientist
discovers principles of
an audio insomnia killer**

By MOHAMMED ULYSSES FIPS, I.R.E.*

LAST year on a tip-off from the Russian underground, with a fake passport, I went behind the Iron Curtain to Moscow to investigate one of the most important Russian electronic inventions made during the past decade. This could not have been done had I not known the Russian language perfectly, and if I had not been an I.R.E.* man. I was thus enabled to reach the famed Professor Vladimir Ivanovitch Nikulturno, the inventor of the new device. The news had leaked through to America that here was a most important basic electronic invention which not only had many peace time applications but important military applications as well. It was more than worth while taking the risk. The new device as shown in these pages was reproduced with American components so that anyone can build the Hypnotron. (Hypnos: from the Greek, sleep.)

Most of the inhabitants of the larger Russian cities today are extremely jittery and apprehensive on account of the American atom bomb threat, so much so that not much else is talked about. This jitteriness has made of the Russians a nation of insomniacs, especially in the large centers.

As one of the foremost psychologists in Soviet Russia, Professor Nikulturno set about to rectify the condition so that his insomniac countrymen could get their much-needed sleep.

It so happens that Professor Nikulturno was the favorite pupil of the world-famed psychologist Ivan Petrovich Pavlov. Our readers know it was Pavlov who made the famous "conditioned reflex" experiments by conditioning dogs to certain stimuli, and so making saliva flow when the animals merely looked at electric lights or heard

the sound of electric bells.

Professor Nikulturno set his goal to condition humans, struck with insomnia, in a similar manner, and finally produced the Hypnotron shown here.

The fundamental circuit was smuggled out of Russia by the writer who almost lost his life thereby. The MVD police were always only two jumps behind him, but he finally made it.

Professor Nikulturno, after two years of study and experimentation, devised a new basic electronic idea which has become known to Russian scientists by the name of "Electronic Indeterminacy". Stripped of all superfluous technical verbiage the device resolves itself into a blocked audio oscillator which, however, never gives the same set of signals twice. In other words, the signal keeps changing in a completely random manner continuously. Hence, when you listen—with or without earphones—to the Hypnotron you never can possibly know when the next signal will come.

To show this diagrammatically see Fig. 1 which explains graphically how the oscillator functions. The dots show the signals and the size of the signal also gives its time duration. It will be seen that with this special oscillator the signal is never twice the same, nor has it ever the same time difference between signals.

Fundamentally, the device is an audio oscillator capable of producing a number of notes, the pitch and duration of which may be caused to vary in a random manner.

The fundamental oscillator circuit is a simple plate-tickler with an iron-core oscillation transformer and grid-leak bias. The grid capacitor or leak, or both, may be varied to change the tonal range. The four capacitors (more may be used if desired), in the grid circuit

are selected to give pleasing notes over a suitably wide range. These resistors are inserted into the circuit or disengaged therefrom by means of small thermostatic bimetallic elements in series with them. They are placed near the tube, which in warming up causes them to open the circuit. Adventitious variations in ventilation, etc., have been shown to be sufficient to cause the units to open in a random manner, especially if they are all cut from the same piece of material but made different in length. A special thermostat (blinker) in the filament circuit of the tube opens it briefly at more or less irregular intervals, causing slight cooling and thereby introducing a further random element in the timing of the notes.

A small triode was found to produce signals of more than sufficient loudness for the application. To adapt the volume to the individual's requirements, a 50,000-ohm variable resistor is shunted across the phones. A 1½-volt "A" and hearing-aid type "B" battery complete the equipment.

In practice the hypnotron—which can be either a battery-operated oscillator or one attached to the electric network—is used either with or without earphones. The earphone method is the more popular because it will not disturb other sleepers or a non sleeper in the same room. If there is only one sleeper in a room then, of course, a loudspeaker can be used.

We have shown only one model to illustrate the technical working of the hypnotron.

In practice when you go to bed you turn on the device, using the adjuster knob to regulate the strength of the signal to the level most satisfactory to you. You then relax and start listening.

Professor Nikulturno insists that just listening to the signal is not satis-

* International Radio Electroneer.

factory. You must count each signal, just as if you were counting sheep. You start with 1 and keep on counting.

The psychological effect of the hypnotron now reveals itself perfectly.

If the signal came always with the same frequency and spaced the same, you would not become drowsy. The important point is that in trying to count with the irregular sequence of the signal, you perform work, i.e. the mind tries to follow the signals. This in itself is tiring. The psychological explanation for this is that you never know when the next signal comes. There may be a quick succession of signals or there may be long lags. In any event you are kept on the jump always and this is tiring.

Within 15 minutes, at the latest, the mind becomes so tired that it refuses to do any further work—you fall asleep.

Does the signal go on when you sleep? No. The canny Professor has seen to this too. Attached to your chest is a mercury switch. After you have fallen asleep you start turning or tossing—as has been proven by many experiments—and the mercury switch therefore acts and breaks the circuit. If you should wake up and need the instrument again, it will have to be reset.

Experience has shown that the hypnotron is perhaps the most efficient sleep inducer ever produced. Millions of hypnotrons were used in Russia at the height of its popularity, before the authorities stepped in—for reasons which will become apparent at the end of this article.

When the Hypnotrons first appeared on the Russian market, people grabbed them up like crazy—they caught on like wildfire. Made at a low price, the device was within the reach of most of the workers. Due to the crowded living conditions in Russian homes, where an average of four people sleep in one room, most Hypnotrons were used with loudspeakers, so a number of persons could be put to sleep simultaneously.

Rich and poor used the sleep-inducer—even members of the Politbureau had them in their homes. But after a while there were rumblings against the Hypnotron—rumblings which soon burst into an ugly staccato of denunciations from the men higher up. This finally became so insistent that the government not only stopped making Hypnotrons but forbade their use entirely, making it a criminal offense even to own one! What had happened? Nothing—except that the sleep-inducer was too efficient. It became habit-forming like morphine. The Russians became a nation of doped snoozers. Constantly more and more afraid of atom-bombing, they sought surcease in an exhausting sleep right after dinner, and the longer they used the Hypnotron the more sleep-drugged they became. Alarms no longer woke them in the morning from their stupor. Plant managers reported thousands of workers were late from half an hour to two hours. Russia was being undermined by a sleep-gadget! This sort of thing patently could not go on—it was nothing less than Soviet-suicide.

One morning, in the early spring of 1950—according to advice received via the Russian underground—Stalin summarily summoned before him an astonished Vladimir Ivanovitch Nikulturno. This is the gist of the historic conversation:

“Worthy Comrade Vladimir Ivanovitch Nikulturno! While Russia must be eternally grateful to you for your great scientific accomplishments of the

have foreseen what would happen if millions used your infernal contraption—or are you a psychologist? I gravely doubt it!

“Dog Nikulturno! Not satisfied with these terrible offenses, it has come to our ears that you recently gave out important scientific information on your work—some of which is of a high military nature and therefore secret—to a capitalistic American swine by the

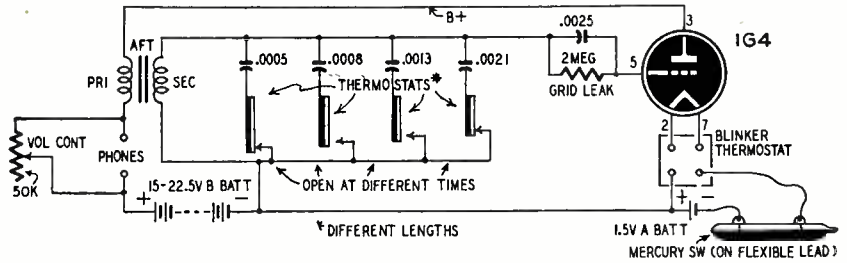

The hypnotron circuit. Grid capacitors are selected to give a pleasing tone.

past which have greatly enriched our country, you must also be quite aware of the sinister situation which has arisen with your fellow Russians, all due to your latest invention—the Hypnotron.

“Tovarich Nikulturno! You know that today millions of Russians have become useless slaves and abject addicts to your wicked sleep-gadget, unable to tear themselves away from their bedsteads. Russians are no longer free men—they are sloths!

“Gospodin Nikulturno! Your Hypnotron has undermined our entire peace and war economy—worse yet, Russians

name of Mohammed Ulysses Fips, whom you even entertained in your own home. You must surely have known that he was only a low American spy bent on destroying your country!

“Pig-Traitor Nikulturno! I charge you with the multiple offenses of having deliberately used your office of Chief Psychologist of Russia to bring your country to the brink of disaster. Your incompetence as a scientist is only matched by your treason to Soviet Russia in dealing with our arch-enemy: The U.S.A.

“I therefore order you—traitor Vladimir Ivanovitch Nilkulturno—shot at

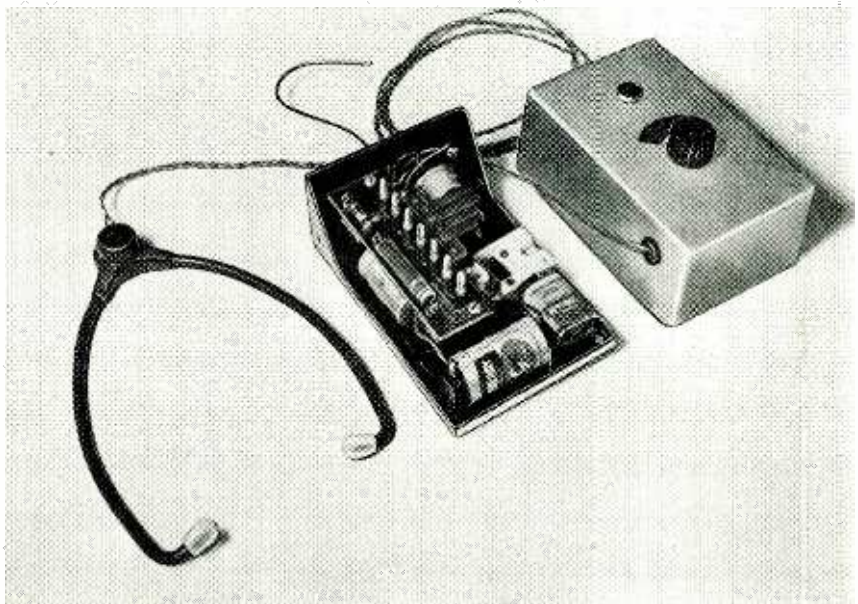

The inside of the unit. It is battery-operated and completely self-contained.

have been bereft of their age-old courage, their inborn stamina, their glorious Slav stoicism—they have become cringing curs like capitalistic dogs! You as Russia's greatest psychologist have completely misled the Government and the people! You of all men should

sunrise, tomorrow. And do you perhaps know what is tomorrow? As a psychologist, you will have a good laugh at this, Hah! Hah! Mister Nikulturno! Tomorrow is

APRIL 1."

How an Electric Brain Works

Part VII—Analysis of Simon as a complete working unit.
How the various sections are made to work together

By EDMUND C. BERKELEY and ROBERT A. JENSEN

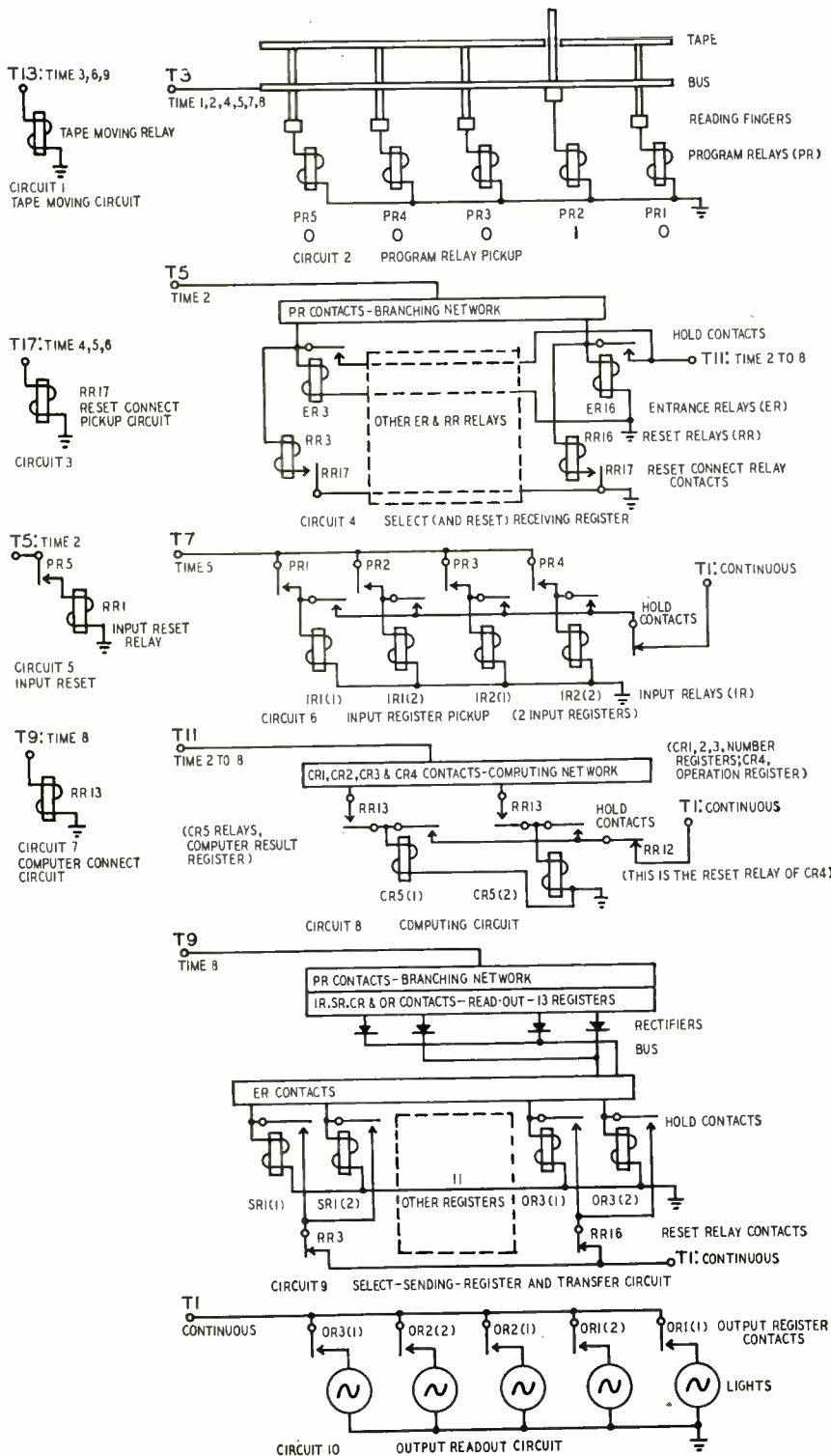

IN THE last article, we began to talk about Simon, a complete baby electric brain, made of relays, a stepping switch, and a paper-tape feed. We anchored down the terms "input," "output," "computer," "storage," and "control," each into a particular set of relays that actually perform that function.

Now, what is the general scheme, and the circuit wiring, whereby this equipment works as a complete electric brain?

This may be seen in Fig. 1, which shows, sketchily and schematically, the 10 essential circuits of Simon, beginning with moving the tape, and ending with putting information out in the output lights.

To explain these circuits, we should start with their timing. Each of the terminals shown, T1, T3, etc., is energized at a certain time or times by means of the stepping switch as the calculation proceeds.

For Simon or any electric brain to operate, things have to happen precisely in succession, in sequence, one after another. This is the heart of automatic control. In Simon the timing is done by the stepping switch. The Clare Relay Co. stepping switch that we bought on the war surplus market when we were constructing Simon, had 20 timing points and 6 levels, but we found that it stepped too fast. The easiest change to make was to wire the points together in pairs, thus effectively giving the stepper 10 timing points. Also, we replaced the stepper's nonbridging wipers (which broke current between each point and the next) with bridging wipers, so that we would have uninterrupted current for holding up relays when desired. The switch was modified by installing a coil to operate on 24 volts d.c., the standard operating voltage for Simon.

As we worked out the circuits of the machine, the points were wired together to give seven terminals that were numbered T3, T5, T7, T9, T11, T13, and T17 (see Fig. 2), carrying currents at different times. The odd numbers were used to indicate that the current was of the same sign, positive, as the source,

Fig. 1—Simon's 10 essential circuits, showing operational sequence and connections to stepping switch terminals.

GET IT!

1951 ALLIED catalog

free!

the only complete
up-to-date catalog for
Everything in Radio, Television
and Industrial Electronics

212 value-packed pages

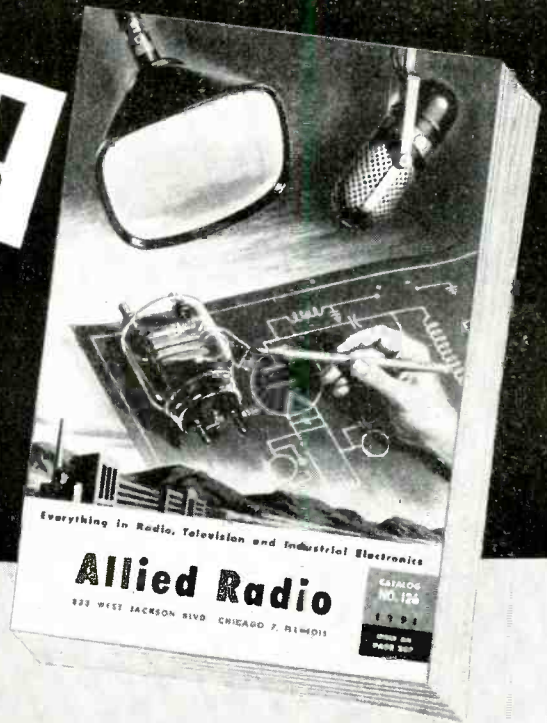

Send for it today!

Here's the only *complete, up-to-date* Buying Guide to TV, Radio and Industrial Electronics—packed with the world's largest selections of quality equipment at lowest, money-saving prices. See the latest in TV, AM and FM receivers; radio-phonos; new Sound Systems and P.A. equipment; High-Fidelity Custom Sound components; recorders and accessories; full selections of newest Amateur receivers and station gear; test instruments; builders' kits; huge listings of parts, tubes, tools, books—the world's *most complete stocks* of quality equipment.

ALLIED gives you *every* buying advantage: speedy delivery, expert personal help, lowest prices, assured satisfaction, liberal time payment terms. Get the latest 1951 ALLIED Catalog. Keep it handy—it will save you time and money. Send for your FREE copy!



THE WORLD'S LARGEST STOCKS

- Radio Parts Unlimited
- Test Instruments
- Television & Home Radios
- P.A. and Hi-Fi Equipment
- Amateur Station Gear
- Supplies for Industry

QUICK, EXPERT SERVICE



SEND TODAY FOR RADIO'S LEADING BUYING GUIDE

free



ALLIED IS YOUR TELEVISION HEADQUARTERS

TV

To keep up with TV, depend on ALLIED! Count on us for the latest releases and largest stocks of picture tubes, component parts, antennas and accessories—plus the latest in TV tuners and kits. If it's anything in TV—depend on ALLIED!

ALLIED RADIO

the World's Largest Radio Supply House

EVERYTHING IN ELECTRONICS

ALLIED RADIO CORP.
833 W. Jackson Blvd., Dept. 2-D-1
Chicago 7, Illinois

Send FREE 212-page 1951 ALLIED Catalog No. 126

Name _____

Address _____

City _____ Zone _____ State _____

in contrast with negative, or the ground, terminal T2.

Timing of the machine

Now, how are these timed currents used to energize the relays and circuits of Simon? This is shown in the timing chart of Fig. 3; it is not altogether complete, but most of the operation of the machine is indicated there, and it will be understandable to readers who have followed the partial diagrams in earlier instalments of this series. Let

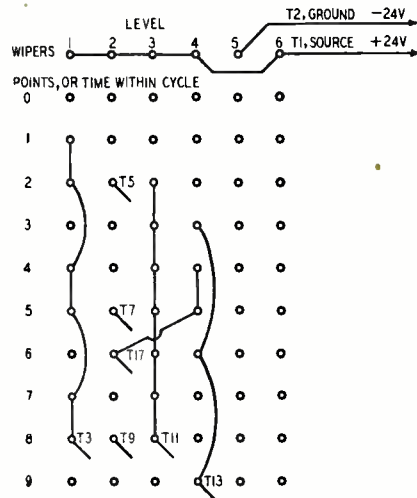

Fig. 2—How the 6-level stepping switch that activates the relay banks is wired.

us go through the timing chart of Fig. 3 and the diagrams of Fig. 1 and see what we can tell from them.

At time 1, there is a red O on the first row, and a red X on the second row, and a red line connects them. This means that at time 1, we read through holes in the paper tape (which at this time is still) and we pick up the corresponding program relays (see Circuit 2 in Fig. 1). At time 2, similarly interpreting the red line, we read through the positioned contacts of program relays to select the receiving register, and pick up its entrance relay, which is held up until time 8 (see Circuit 3). We also optionally (if there is a hole in position 5 on the tape) pick up RR1 (reset relay No. 1), which action re-

sets the input register by interrupting its hold current (see Circuits 5 and 6). At time 3, all that happens is that we move tape (see Circuit 1), and drop out the program relays. At time 4, we read through tape again and pick up the program relays once more, for they are the relays in which the information from the tape is always immediately put (see Circuit 2). Also at time 4, we read through the hold contact of the selected entrance relay and pick up the matching reset relay, which resets the receiving register by interrupting its hold current (see Circuits 3 and 4). At time 5, we read through contacts of the program relays, and pick up the input registers 1 and 2, storing there a number or operation (see Circuit 6). At time 6, we move tape and drop out the program relays. At time 7, we read through holes in the paper tape, and pick up the program relays once more (see Circuit 2), this time to select the sending register.

At time 8, we transfer information (see Circuit 9). We read through, from the source:

1. contacts of the program relays which select a sending register (these relays were energized at time 7);
2. contacts of that sending register (held up by continuous current);
3. the bus;
4. the contacts of the receiving register's Entrance Relay (which have been closed and have been held from time 2 to 8);
5. and the coils of the selected receiving register, to ground.

And at time 9, we move tape preparatory to the next cycle, and drop out the program relays and entrance relay.

Independently of this main sequence of events, computing takes place in Circuit 8. The computer consists of three registers CR1, CR2, CR3 which take in numbers, and a fourth register CR4 which takes in an operation. Suppose that on previous cycles, these registers have been filled with the desired information, and that CR4 is the last one so filled. Then by means of T11, current is passed through the contacts of those four registers. To avoid back circuits, however, the computer is con-

nected only at time 8 to the fifth computer register, CR5, which stores results (see Circuits 8 and 7)

Storing and transferring

The two things that are the first order of business in an electric brain are to store information and to transfer information. In Simon, information is stored in any one of 16 registers, each capable of holding two binary digits. Information is transferred as pulses of current along a two-line bus. The 16 registers of Simon and the codes used for "calling" them (either to transmit information they hold or to receive and store information) are:

Register	Code	Entrance Relay	Reset Relay
IR1	0000	none	RR1
IR2	0001	none	RR1
SR1	0010	ER3	RR3
SR2	0011	ER4	RR4
SR3	0100	ER5	RR5
SR4	0101	ER6	RR6
SR5	0110	ER7	RR7
SR6	0111	ER8	RR8
CR1	1000	ER9	RR9
CR2	1001	ER10	RR10
CR3	1010	ER11	RR11
CR4	1011	ER12	RR12
CR5	1100	none	RR12
OR1	1101	ER14	RR14
OR2	1110	ER15	RR15
OR3	1111	ER16	RR16

In the last article and in previous articles, we told most of the story about the input, output, and storage registers of Simon. The computer registers, however, require some more explanation here.

Computer registers

The computer of Simon consists of relays and wiring by means of which information is operated on and changed into other information. Simon's computer registers (abbreviation CR) are: CR 1 to 3, which take in numbers; CR4, which takes in the operation; CR5, which gives out the result; and CR 6 to 9, which help in the operations involving arithmetical carrying and were recently added.

Simon at present writing has nine operations built into it. For Simon to perform any one of these operations, he must be instructed. How do we instruct him? These operations also have certain codes, and here are the codes and the names of the operations:

No.	Code	Operation
1	0000	Add, No Carry;
2	0001	Negate, No Carry;
		Fours Complement
3	0010	Greater Than
4	0011	Selection
5	0100	Logical AND
6	0101	Logical NOT; Threes
		Complement
7	0110	Logical OR
8	1000	Add, Subject to
		Carry from
		Previous Addition
9	1001	Negate, Subject to
		Carry from
		Previous Negation

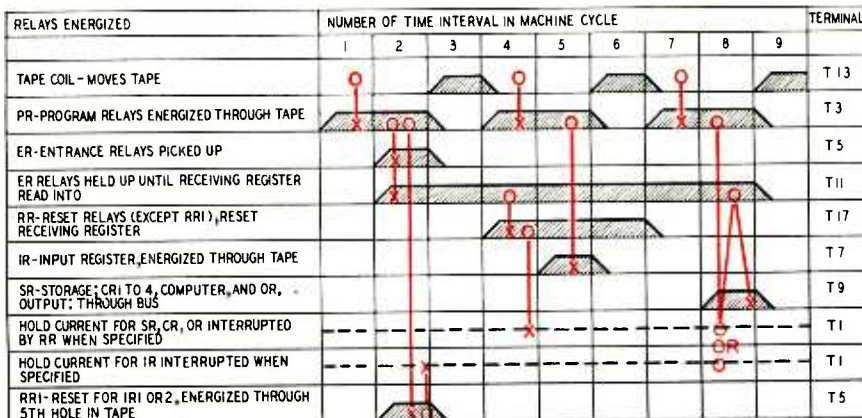

Fig. 3—Timing chart, showing how operations are carried through the machine.

Now!

**MORE POWERFUL
FRINGE AREA
RECEPTION . . .**

**WITH THE
*New Bazuka
antenna!***



**Your skyline re-
mains uncluttered
by oversized
antennas!**

**A matter of seconds
for installation!**

**Designed for strong
reception in fringe
areas!**

**Laboratory tested
for top service and
consistent better re-
ception!**

**For more complete
information about
this new antenna
engineering feat,
write today for illus-
trated booklet.**

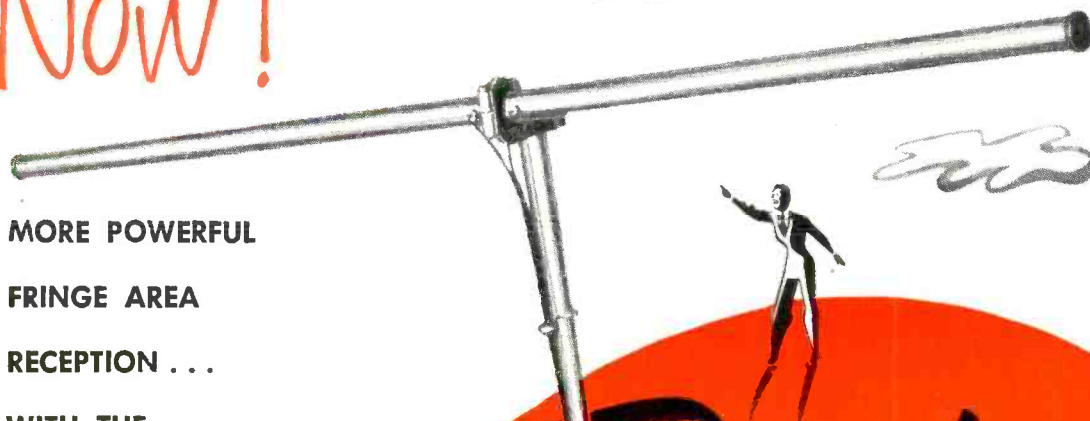

Bazuka antenna

The King  of Antennas.

Here's the antenna that meets your demand for stronger, more efficient TV reception. BAZUKA . . . the new triumph in antenna pioneering is designed for ideal fringe and local area reception. Its compact design makes installations a matter of seconds, regardless of weather or location. Heavy duty construction eliminates all undue vibrations and swaying. Thanks to rigid engineering tests, BAZUKA now provides you with consistent top-notch reception.

Tests have proven that where ordinary antennas receive weak signals at fringe areas, Bazuka, on the other hand maintains a strong, true signal.

VERI-BEST

TELEVISION PRODUCTS, INC.
233 SPRING STREET • NEW YORK 13, N. Y.

Now, what do we mean by these operations? Regularly the complete meaning of an operation is described by giving a table of the outputs for some of the inputs, and then covering the remaining cases of output-input by general statements. This we have done in Chart 1, in rather condensed language. The lower case (not capital) letters a, b, c, refer to numbers that Simon knows, 0, 1, 2, 3. The lower case letters p, q, r, refer to *truth values*: the truth value of a statement is 1 if the statement is true, and 0 if the statement is false. A primitive way of indicating a truth value is with check marks (✓) and crosses (×). But check marks and crosses are not numbers like 1 and 0, and cannot be combined like numbers, and there is no need to bother with them, for using them is like using a crystal set when you could use a console radio. The expression $T(\dots)$, which is read: "T of ...", where ... is some statement, is a nice short way of writing "the truth value of ...". Truth values are becoming more important all the time as a means of designing and economizing electronic computer circuits. For example, the electronic computer Maddida was designed largely by truth value algebra instead of circuit diagrams.

The capital letters P, Q, R refer to statements of which the truth values are p, q, r, respectively. Statements have to be expressed usually with words, and sometimes may be expressed in other ways. But the little letters p, q, r are truth values and are always 1 or 0. It is readily understood that:

$p = T(P)$, $q = T(Q)$, and $r = T(R)$.
 For example, let us consider the fourth operation, that of selection. The general statement for this operation is $c = ap + b(1 - p)$. What will this rule give us in a concrete case? Suppose a is 2, and b is 3, and p is the truth value of the statement "0 is greater than 1."

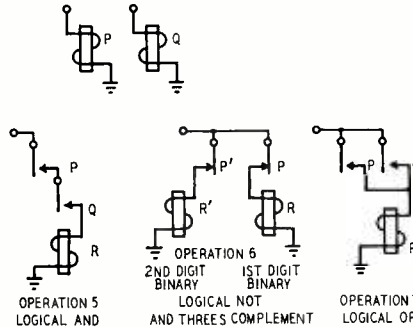

Fig. 4—Logical circuits. "And" circuit outputs a pulse only if both relays are closed; "not" circuit only if both are open; "or" if either or both are closed.

In other words, what we want to do is select 2 if 0 is greater than 1, and select 3 if 0 is not greater than 1. Here the statement that we are interested in is "0 is greater than 1"; this statement is false, and so p, its truth value, is 0. Putting $a = 2$, $b = 3$, and $p = 0$, in the rule,

$$c = a + b(1 - p) = [2 \times 0] + [3 \times (1 - 0)].$$

The arithmetical result of this is 3, which of course agrees with what our common sense tells us. Why do we resort to all this roundaboutness? Because when you want to tell a mechanical brain to do something, you have to be very explicit.

Operations 8 and 9 need some comment. Their purpose is to enable us to handle numbers of more than two binary digits. If we are adding two four-digit binary numbers, for example, first we attend to the two binary digits at the right, using operation 1, Addition Without Carry. Second we attend to the two binary digits at the left, using operation 8, Addition, Subject to Carry, this process remembering whether or not there was a carry from that first step.

The circuits for operation 1 to 4 are given in Chapter 3 of *Giant Brains*, on pages 36 to 38. The circuits for operations 5 to 7 are given schematically

in Fig. 4. We note that "logical NOT" and "three's complement" are the same operation, with the same code 0101. This is because if we use only the right-hand binary digit, we have the logical-NOT operation; and if we use both the left-hand and the right-hand binary digits, we have the three's complement. The circuits for operations 8 and 9 are not hard to design, in one way or another; there is no space to give them here.

Programming and timing

The next thing we have to consider is the programming and timing of the machine as a whole.

In Simon, as constructed, we are using only one tape for both instructions and numbers. It proved to be convenient when constructing Simon to cause the tape to be read three times in each complete machine cycle, at time 2, time 5, and time 8. We call these three readings three *entries* of information into Simon. The first entry, at time 2, specifies the register which is to receive the information. When this entry is read, it causes the entrance relay of the receiving register to be energized, and so connects the coils of the receiving register to the bus, and clears out any information previously in it. The second entry, at time 5, puts any number or operation from the tape into input registers 1 and 2, so that the number or operation can be made use of in the machine. The third entry, at time 8, specifies the sending register, i.e., the register from which information is to be transmitted, and at the same time causes the information in that register to pass through the bus into the receiving register.

In some electric brains, we would have to consider carefully the subsequences of the timing of the routines of such computing operations as multiplication and division. This is not the case however in Simon, because every computing operation is completed in the machine cycle following the designating of the operation in computer register 4. If we should wish to do multiplication or division on Simon, we would need to program it by means of the instruction tape, and the use of arithmetical and logical operations.

For example, what would we punch in the tape if we wanted the operation "selection" (code 0011) to go into computer register 4 (code 1011), the register which chooses the operation the computer is to utilize? We would punch, in three successive lines of tape:

Entry	Punched Holes	Meaning
1	11011	Get ready to receive in CR 4, and clear IR 1 and 2.
2	00011	Put operation selection in IR 1.
3	00000	Transfer out of IR 1.

This description of Simon and its operations is incomplete. We have not touched on the wiring of the front panel, so that different types of automatic or manual operations are possible. We have not covered the two other

Chart 1—Operations of Simon

<p>Operation 1 Addition without carry $c = a + b$</p> <table border="1"> <tr><td>a</td><td>0</td><td>1</td><td>2</td><td>3</td></tr> <tr><td>b</td><td>0</td><td>1</td><td>2</td><td>3</td></tr> <tr><td>c</td><td>0</td><td>1</td><td>2</td><td>3</td></tr> <tr><td>0</td><td>0</td><td>1</td><td>2</td><td>3</td></tr> <tr><td>1</td><td>1</td><td>2</td><td>3</td><td>0</td></tr> <tr><td>2</td><td>2</td><td>3</td><td>0</td><td>1</td></tr> <tr><td>3</td><td>3</td><td>0</td><td>1</td><td>2</td></tr> </table>	a	0	1	2	3	b	0	1	2	3	c	0	1	2	3	0	0	1	2	3	1	1	2	3	0	2	2	3	0	1	3	3	0	1	2	<p>Operation 6 Logical "not" $r = T(\text{not } P)$</p> <table border="1"> <tr><td>p</td><td>0</td><td>1</td></tr> <tr><td>r</td><td>1</td><td>0</td></tr> </table> <p>Three's complement $c = 3 - a$</p> <table border="1"> <tr><td>a</td><td>0</td><td>1</td><td>2</td><td>3</td></tr> <tr><td>c</td><td>3</td><td>2</td><td>1</td><td>0</td></tr> </table>	p	0	1	r	1	0	a	0	1	2	3	c	3	2	1	0
a	0	1	2	3																																																
b	0	1	2	3																																																
c	0	1	2	3																																																
0	0	1	2	3																																																
1	1	2	3	0																																																
2	2	3	0	1																																																
3	3	0	1	2																																																
p	0	1																																																		
r	1	0																																																		
a	0	1	2	3																																																
c	3	2	1	0																																																
<p>Operation 2 Subtraction or negation without carry = four's complement $c = 4p - a$</p> <table border="1"> <tr><td>p</td><td>T(a is 1, 2, 3)</td></tr> <tr><td>a</td><td>0</td><td>1</td><td>2</td><td>3</td></tr> <tr><td>c</td><td>0</td><td>3</td><td>2</td><td>1</td></tr> </table>	p	T(a is 1, 2, 3)	a	0	1	2	3	c	0	3	2	1	<p>Operation 7 Logical "or" $r = T(P \text{ or } Q)$</p> <table border="1"> <tr><td>q</td><td>0</td><td>1</td></tr> <tr><td>p</td><td>0</td><td>1</td></tr> <tr><td>r</td><td>0</td><td>1</td></tr> </table>	q	0	1	p	0	1	r	0	1																														
p	T(a is 1, 2, 3)																																																			
a	0	1	2	3																																																
c	0	3	2	1																																																
q	0	1																																																		
p	0	1																																																		
r	0	1																																																		
<p>Operation 3 Greater than $p = T(a \text{ is greater than } b)$</p> <table border="1"> <tr><td>a</td><td>0</td><td>1</td><td>2</td><td>3</td></tr> <tr><td>b</td><td>0</td><td>1</td><td>2</td><td>3</td></tr> <tr><td>p</td><td>0</td><td>0</td><td>1</td><td>1</td></tr> </table>	a	0	1	2	3	b	0	1	2	3	p	0	0	1	1	<p>Operation 8 Addition, subject to carry $c = a + b + p$</p> <p>$p = T(\text{previous addition was } 1 + 3, \text{ or } 2 + 2, \text{ or } 3 + 2, \text{ or } 3 + 3)$</p> <table border="1"> <tr><td>a</td><td>0</td><td>1</td><td>2</td><td>3</td></tr> <tr><td>b</td><td>0</td><td>1</td><td>2</td><td>3</td></tr> <tr><td>p</td><td>0</td><td>0</td><td>1</td><td>1</td></tr> <tr><td>c</td><td>0</td><td>1</td><td>2</td><td>3</td></tr> </table>	a	0	1	2	3	b	0	1	2	3	p	0	0	1	1	c	0	1	2	3																
a	0	1	2	3																																																
b	0	1	2	3																																																
p	0	0	1	1																																																
a	0	1	2	3																																																
b	0	1	2	3																																																
p	0	0	1	1																																																
c	0	1	2	3																																																
<p>Operation 4 Selection $c = ap + b(1 - p)$</p> <table border="1"> <tr><td>p</td><td>0</td><td>0</td><td>0</td><td>1</td><td>1</td><td>1</td></tr> <tr><td>a</td><td>0</td><td>1</td><td>2</td><td>3</td><td>0</td><td>1</td><td>2</td><td>3</td></tr> <tr><td>c</td><td>0</td><td>1</td><td>2</td><td>3</td><td>0</td><td>1</td><td>2</td><td>3</td></tr> </table>	p	0	0	0	1	1	1	a	0	1	2	3	0	1	2	3	c	0	1	2	3	0	1	2	3	<p>Operation 9 Subtraction or negation subject to carry $c = 3 - a + q(4p - 3)$</p> <p>$p = T(a \text{ is } 1, 2, \text{ or } 3)$</p> <p>$q = T(\text{previous negation without carry was of } 0)$</p> <table border="1"> <tr><td>q</td><td>0</td><td>1</td></tr> <tr><td>a</td><td>0</td><td>1</td><td>2</td><td>3</td></tr> <tr><td>p</td><td>0</td><td>1</td><td>1</td><td>1</td></tr> <tr><td>c</td><td>3</td><td>2</td><td>1</td><td>0</td></tr> </table>	q	0	1	a	0	1	2	3	p	0	1	1	1	c	3	2	1	0								
p	0	0	0	1	1	1																																														
a	0	1	2	3	0	1	2	3																																												
c	0	1	2	3	0	1	2	3																																												
q	0	1																																																		
a	0	1	2	3																																																
p	0	1	1	1																																																
c	3	2	1	0																																																
<p>Operation 5 Logical "and" $r = T(P \text{ and } Q)$</p> <table border="1"> <tr><td>q</td><td>0</td><td>1</td></tr> <tr><td>p</td><td>0</td><td>1</td></tr> <tr><td>r</td><td>0</td><td>0</td></tr> </table>	q	0	1	p	0	1	r	0	0																																											
q	0	1																																																		
p	0	1																																																		
r	0	0																																																		

FREE!

With purchase of ONE Sylvania Picture Tube

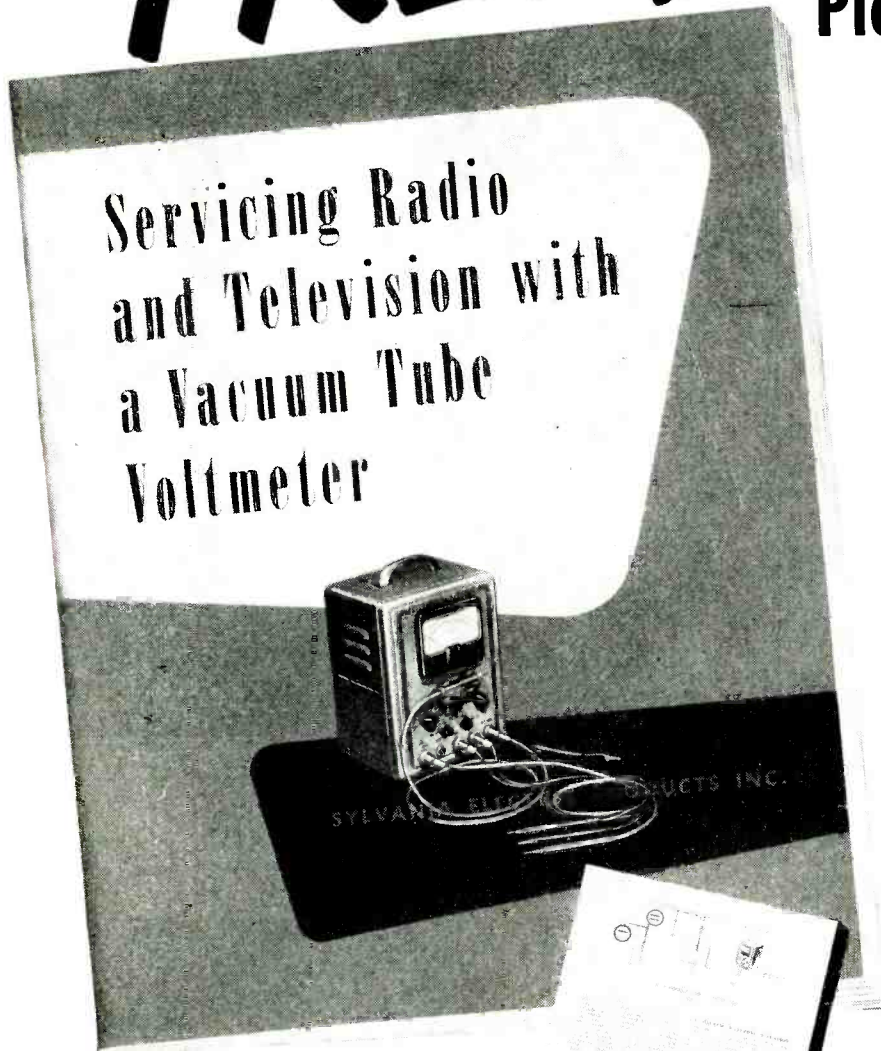

**ACT NOW! Offer good
only April 1st to May 31st**

Here's a book that will save you hours of service time every week. You'll be amazed how it will simplify everyday service problems. You can't buy this book! It comes to you **FREE** with the purchase of just one Sylvania TV Picture Tube from your regular Sylvania Distributor. That's all, simply buy a Sylvania Picture Tube, of any type, and your Distributor will give you a copy free. See or write him today.

- 48 pages of pictures and diagrams.
- **COVERS RADIO SERVICING**—Signal Tracing, Alignment, AVC and AFC Checking, Measurement of Voltages, Signal Levels, Power Output, Bandwidth and much more.
- **COVERS TV SERVICING**—Signal Tracing, Bandwidth Measurements, Wavetrap Checking, Sound Channel Tests and Alignment, Low and High Voltage Checks, Signal and Deflection Voltage Measurements etc.
- **COVERS AUDIO AMPLIFIER SERVICING**—DC, AC, and Signal Level Measurements; Tone Control, Fidelity, and Gain Tests, Distortion, Power Output and Noise Level Measurements; Signal Tracing, Speaker Matching.
- Covers 19 Miscellaneous Applications of VTVM—Detecting Gassy Tubes, Checking Capacitors, Q Measurement, Turns Ratio Measurement, Impedance Checking.

SEE YOUR
SYLVANIA
DISTRIBUTOR
FOR YOUR COPY
TODAY

Sample pages
showing detailed,
easy-to-read
diagrams.



SYLVANIA ELECTRIC

RADIO TUBES; TELEVISION PICTURE TUBES; ELECTRONIC PRODUCTS; ELECTRONIC TEST EQUIPMENT; FLUORESCENT TUBES, FIXTURES, SIGN TUBING, WIRING DEVICES; LIGHT BULBS, PHOTOLAMPS; TELEVISION SETS



"It's Extra Dollars For Me..."

with **Jensen NEEDLES**

Increase your income 50% annually by selling a needle on every service call. It's easy to suggest a new needle when servicing a TV or radio set... the easiest dollars you ever made!

FREE!

Jensen's New 1951 Needle Wall Chart Tells You What To Use



JENSEN REPLACEMENT NEEDLE KIT

Contains the most popular sellers. Enables you to take care of 90% of all replacements. Get your kit and free wall chart from your jobber today.



Jensen INDUSTRIES, INC.

329 So. Wood St., Chicago 12, Ill.

uses of the 5th hole in the program tape, only mentioning that at time 2 in the machine operation it is used for optional reset of the input register. We have not given the specifications of the rectifiers, capacitors, and the rest of the parts list. The basic relay used is Allied Control or close 24-volt, 300-ohm, d.c., airplane-type, bought on war surplus, with either 4 poles double-throw or as many poles as can be found. We have not discussed the subject of coding problems for the machine, nor the range of problems that the machine can do. We have not discussed the ways in which this machine can be further expanded to do useful work. If there is sufficient interest, these matters may be covered to some extent in the final article of this series.

Construction of Simon

Simon as an idea came into existence at the end of 1947, when, at a meeting of the Association for Symbolic Logic in New York, Simon was discussed by Edmund C. Berkeley, one of the two joint authors of this series of articles. Next Simon became the third chapter in Berkeley's book *Giant Brains or Machines that Think* (John Wiley and Sons, 1949), with the purpose of being a simple introduction on paper to the same type of computing circuits used in the big mechanical brains.

Simon as a real machine was begun in November, 1949, and was finished in April, 1950. The cost of materials was about \$270, and the labor for wiring actually paid for amounted to another \$270. The balance of the labor, design, engineering, mechanical work, etc., was contributed; if it had been paid for, it would have amounted to about \$3,000. Simon was actually constructed by three men: William A. Porter, a skilled technician who had much to do with the construction at Harvard University of two big mechanical brains built there, Mark II and Mark III, and Robert A. Jensen and Andrew Vall, two Columbia University graduate electrical engineering students. Jensen is the joint author of this series of articles.

In the next article we shall begin the discussion of electronic brains. —END—

Over 43,000 Technicians Have Learned

HOW TO GET THE MOST OUT OF BASIC TEST EQUIPMENT

Why Not You, Too?

SERVICING by SIGNAL SUBSTITUTION

A BEST SELLER FOR OVER 9 YEARS! (NEW, UP-TO-DATE, 11TH EDITION)

The Simple, Modern, Dynamic Speed Approach To Receiver Adjustment and Alignment Problems, AM-FM-TV.

- Nothing complex to learn
- Universal — non-obsolete
- No extra equipment to purchase
- Employs Only Basic Test Equipment

Ask for "S.S.S." at your local Radio Parts Jobber or order direct from factory.

only 40¢

100 pages. Invaluable information that will help you re-double the value of your basic test equipment.

PRECISION APPARATUS COMPANY, INC. • 92-27 Horace Harding Blvd., Elmhurst 4, N. Y.



Suggested by Richard Rogers, Brighton, Mass.

"John had to be converted too. He's color blind."

"The Set the Experts Own"

hallicrafters

precision television



TELEVISION CAMERAMAN
Steve Wagner, Chief Cameraman
Leading Chicago TV Station

TELEVISION NEWS EDITOR
Ted Materna, Writer and Editor,
Publisher "National TV Directory"



MODEL 17819

17" Rectangular Tube. Sleek new styling in a performance-price leader. Wood cabinet with mahogany finish. Polished brass trim around front. With the Dynamic Tuner.



the **ONLY** set with the \$2,000,000 *dynamic* tuner

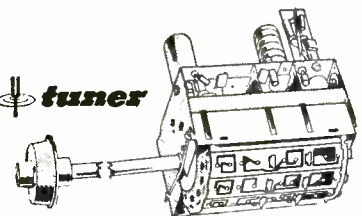

hallicrafters TV
THE SET THE EXPERTS OWN!

WORLD'S LEADING MANUFACTURERS OF PRECISION RADIO & TELEVISION • CHICAGO 24, ILLINOIS

Use The **HANDBOOKS**
the **EXPERTS USE**



GET AHEAD FASTER IN RADIO TELEVISION ELECTRONICS

The Library set assists you in every operation in radio, television and electronics. Gives you the fundamentals, complete ground work, understanding of all types of radio, television, electronic gear and their circuits, including theory of operation.

Shows you expert methods of planning, building, installing, operating, testing, adjusting, and servicing. The know-how of radio, television and electronics presented in plain language and simple terms with easy to understand pictures and working diagrams.

You get 1800 pages of basic knowledge, methods and data of radio, television, electronics completely illustrated with over 2000 pictures, drawings, codes, charts and graphs.

Written by the Boyce-Roche experts who make electronic manuals for the U.S. Signal Corps.

SPECIAL OFFER—Save one dollar. Send for the **RADIO & TELEVISION LIBRARY SET** and get **The RADIO & ELECTRONICS HANDBOOK** and **The VIDEO HANDBOOK** in handsome slip case as shown above for**\$10.90**

RADIO & ELECTRONICS HANDBOOK provides instruction and reference on fundamentals, parts, tubes, circuit elements, receivers, transmitters, amplifier systems, power supplies, antennas, meters, test equipment, and accessories, with complete Data Section**\$5.95**

VIDEO HANDBOOK teaches television and provides complete handbook reference on all phases with full sections on principles of television, receivers, antennas, test equipment, servicing, pattern interpretation, transmitters, show production and more**\$5.95**

SEND NO MONEY

10 DAY FREE EXAMINATION COUPON
(Good only while special Library Set offer lasts)

BOYCE-ROCHE BOOK CO.
Caldwell 44, New Jersey

Send Library Set @ \$10.90
 Radio & Electronics Handbook @ \$5.95
 Video Handbook @ \$5.95

In ten days I will send you price plus postage or I will return book(s) postpaid. (Offer good only in U. S.)

Name

Address

City, Zone, State

Employed By

Save Postage. We pay postage if you enclose full price(s) now. Money back on same return privilege.

Electronics and Music

Part X—Construction details and tuning procedure of the Thyratone

By **RICHARD H. DORF***

IN LAST month's article we described the principles on which the Thyratone operates. In that article the complete schematic diagram and

some photographs appeared. This month we shall discuss construction, adjustment, operation, and modifications. It is therefore a good idea to have the March article on hand for reference while this is being read.

*Audio Consultant, New York

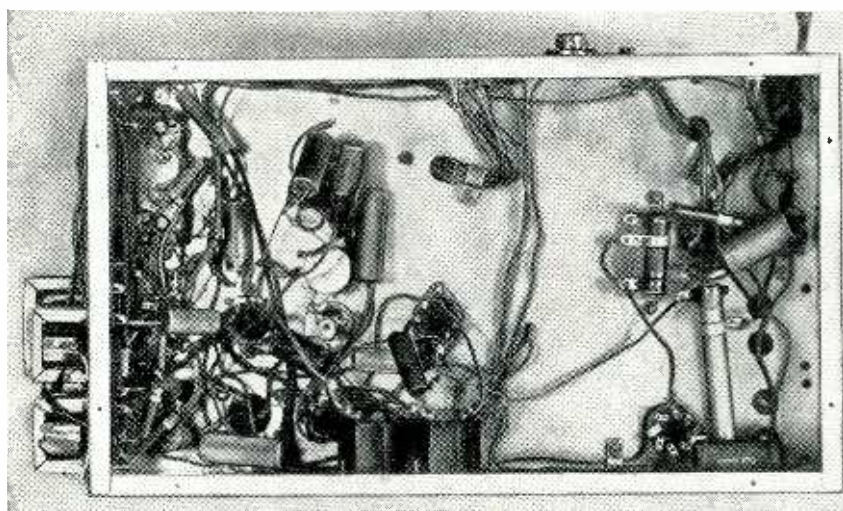

Photo A—Underside of the Thyratone's chassis. Other constructors may find that a somewhat different layout will make the wiring considerably easier.

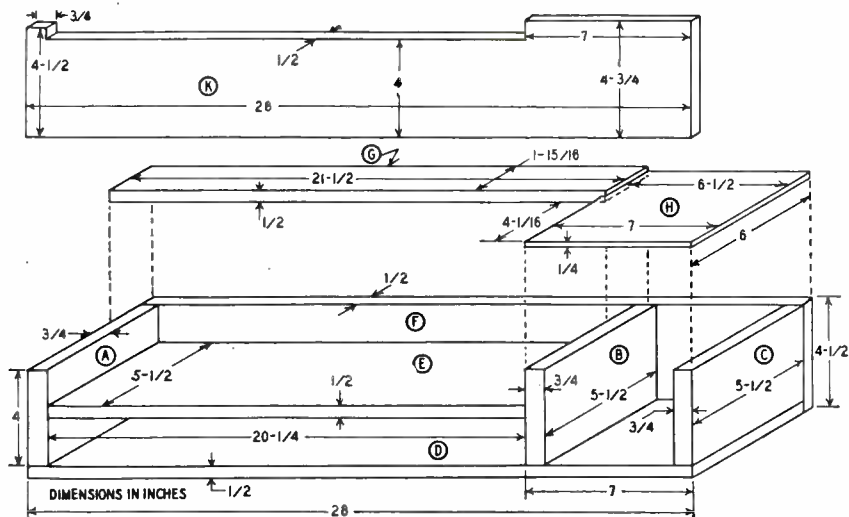

Fig. 1—Exploded diagram of the keyboard housing showing assembly details.

A, B, C—sides and partition— $4 \times 5\frac{1}{2} \times \frac{3}{4}$
D—bottom— $28 \times 5\frac{1}{2} \times \frac{1}{2}$
E—contact board— $20\frac{1}{4} \times 5\frac{1}{2} \times \frac{1}{2}$
F—back— $28 \times 4\frac{1}{2} \times \frac{1}{2}$
G—key mask— $21\frac{1}{2} \times 1\frac{15}{16} \times \frac{1}{2}$
H—switchboard— $6 \times 7 \times \frac{1}{4}$ (note slot)
K—front— $28 \times 4\frac{3}{4} \times \frac{1}{2}$ (note shape)
All dimensions in inches

Housings

The instrument is in two principal parts, the electronic chassis and the keyboard unit. The chassis is a 10 x 17 x 3-inch aluminum unit which, after completion of all the construction and adjustment, can be mounted in a suitable wooden cabinet used for the speaker.

The keyboard unit was especially constructed of wood. While it serves the purpose well, it is a trifle large and heavy; that could probably be cured by using lighter wood.

A three-dimensional drawing of the keyboard unit appears in Fig. 1. This sketch, handed to a cabinetmaker, will result in a satisfactory unit. If the reader builds his own, the list of wood pieces in the figure should be helpful. Comparing the drawing with the keyboard unit photograph in last month's story should make the scheme clear.

Referring to the photo of the chassis top in last month's issue, the power supply—transformer, can capacitor, rectifier, two chokes, and voltage-regulator tube—are at the right end of the chassis. At the left end, from front to rear, are the three tone generator 884's, 8-, 16-, and 32-foot, and the 6SN7-GT which amplifies the outputs of the 8- and 16-foot generators. To the right of the latter is the vibrato choke, and in front of it the second 6SN7-GT. Next to the right, from front to rear, are the 6SJ7, the present volume control, the neon lamp, and one 6G6-G. The output

transformer is at rear center, with the other 6G6-G in front of it. All the tone filter components (except for the inductors) are mounted on the three double terminal boards atop the chassis. The inductors had to be kept far from the power supply, so are mounted on the left side of the chassis.

On the front chassis apron are four connectors. The leftmost is a 20-pin female for the cable running to the keyboard unit. Next is a 2-prong (and grounded shell) connector for the expression pedal. An ordinary phone jack follows for the speaker, and at the right is a 2-prong female for the a.c. switch on the keyboard unit.

Photo A shows the underside of the chassis. The wiring under the tone-generator side is rather complex and crowded, which is one reason a change in placement of some components (as discussed later) may be advisable.

Construction steps

The first order of business is to prepare the keyboard unit so that as each portion of the chassis circuit is completed it can be tested and made final.

After obtaining the wood specified in Fig. 1 and cutting it all to shape and to fit, assemble the rear and the two sides and partition, pieces A, B, C, and F. The keys used in the original model were obtained from an old reed organ which was scrapped after being removed from a church to make way for a Baldwin electronic. The individual keys were removed and cut down as in

JFD "Little Giant" TWIN LEAD LIGHTNING ARRESTER
Protects TV Sets Against Lightning and Static Charges



UL Underwriters Laboratories Approved
No. AT105 \$7.25 per lb.
For Regular Twin Lead

BEING IS BELIEVING!
ONLY JFD Lightning Arresters offer you these exclusive patented features . . .

1. Patented strain-relief Retaining Lip which prevents julling or straining against contact points.
2. You actually see positive contact made with lead-in wire.
3. Lead-in contact remains fully visible at all times.
4. No wire stripping. No Arrester Cover to Hide Poor Contacts!

At Your Jobber or Write Direct

JFD MANUFACTURING CO., Inc.
6101D 16th AVENUE, BROOKLYN 4, N. Y.
FIRST in Television Antennas and Accessories

It's New! IT'S A "MUST" FOR RADIO-TV MEN!

IT'S YOURS FOR 7 DAYS FREE TRIAL

BRAND NEW 1951 PUBLICATION

HERE'S WHAT YOU GET IN THIS GREAT CYCLOPEDIA

- TV from A to Z for "in a flash" reference
- 1951 Publication
- Shop & Field Tested Servicing Data
- Dozens of Picture Tube Patterns
- Complete Set of Wave Forms
- Color TV and UHF
- Over 450 Illustrations
- 750 Pages of "How and Why" in Practical Terms

FREE TRIAL COUPON

COYNE ELECTRICAL & TELEVISION-RADIO SCHOOL, Dept. 41-D1, 500 S. Paulina St., Chicago 12, Ill.

I'm interested. Send me a copy of the COYNE TELEVISION CYCLOPEDIA for 7 days FREE EXAMINATION per your offer.

NAME AGE

ADDRESS

CITY ZONE STATE

Check here if you are enclosing \$5.95 or wish the book sent COD (you pay the postman \$5.95 plus COD fee when delivered). You save postage. Same 7 day examination and money back satisfaction guarantee.

COYNE ELECTRICAL AND TELEVISION-RADIO SCHOOL An Institution Organized Not for Profit
500 SO. PAULINA ST. • DEPT. 41-D1 • CHICAGO 12, ILL.



NO SHADOWS

with new
DUAL SPOTLIGHT
Soldering Gun

Pull the trigger of your new light-duty Weller Soldering Gun, and *instantly* twin spotlights focus on the job—banish every shadow. Five seconds later the tip is at soldering heat! No waiting. No wasted current. This streamlined 135-watter—newest of the famous Weller line—is *fast!* Built compactly for working in crowded chassis, too. And the time and power you save pays for your Weller Gun in a few months.



New
135-Watt
Weller
Soldering
Gun

Specially Designed
for TV and Radio Work

- **DUAL SOLDERLITE**—Two prefocused spotlights completely eliminate shadows.
- **OVER/UNDER DESIGN**—Tube construction braces tip and improves visibility.
- **5-SECOND HEATING**—Pull the trigger and you solder!
- **LONGER REACH**—Slides easily into deep chassis; reaches the tightest corners.
- **GREATER CAPACITY**—Smaller, lighter, with greater soldering capacity.
- **TRIGGER-SWITCH CONTROL**—Adjusts heat to the job. No need to unplug gun between jobs.
- **DUAL HEAT**—Single heat 100 watts; dual heat 100/135 watts; 120 volts; 60 cycles. Handles all light-duty soldering.

See new Models WS-100 and WD-135 at your distributor, or write for bulletin direct.

• **SOLDERING GUIDE**—Get your new copy of "Soldering Tips"—revised, up-to-date, fully illustrated 20-page booklet of practical soldering suggestions. Price 10¢ at your distributor, or order direct.

WELLER
ELECTRIC CORP.

828 Packer Street, Easton, Pa.

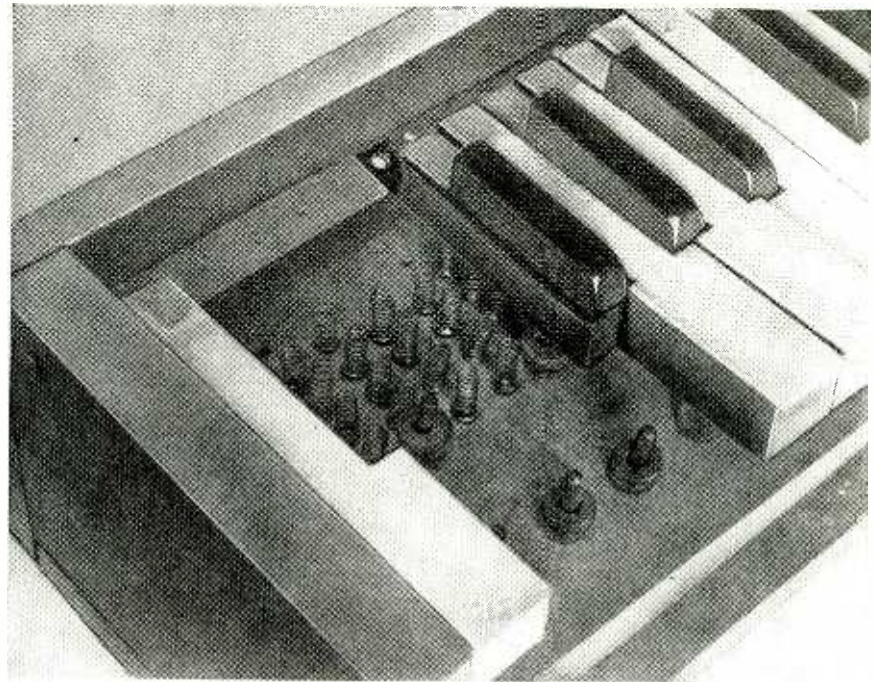

Photo B—Closeup of the keyboard assembly showing the keys and contacts.

Photo B, so that each was about $4\frac{3}{4}$ inches long. The raised portions of the black keys also must be cut down about another $\frac{3}{4}$ inch, so that when the black keys are in place with the white ones, the raised portions stop 4 inches back from the tips of the white keys. This allows the key mask (piece G in Fig. 1) to be put in place eventually, holding all keys at the same height.

Now refer to Photo C, showing the undersides of some of the keys. Along the bottom of each key is a piece of spring metal extending about $\frac{3}{4}$ inch out from the rear. This is a springy metal and serves two purposes. It acts as the contact which electrically connects all the contact springs under each key to ground when the key is pressed, and it is the method by which each key is mounted to the $\frac{5}{8}$ -inch square hollow bar of brass which extends the length of the keyboard ($20\frac{3}{4}$ inches). The bar can be seen in Photo B. It is drilled and tapped at each key location (or self-tapping screws can be used) and the metal extension under each key is fastened to it. When the key is pressed, the metal contacts the four springs; when it is released, the springiness of the metal brings it up again. The writer used transformer laminations for the job.

Now assemble the lowest and highest keys, with their metal strips, and fasten them to the ends of the brass bar. Hold the assembly so that with the keys perfectly horizontal the key tops are even with the top edges of the sides (pieces A and B in Fig. 1). Set in place the contact board (piece E) so that it will hold the bar in this position. Then remove the bar and keys.

The next job is to place the guide pins at the front of each key so that when the key is in place the guide slot underneath it (see Photo C) will engage the pin to prevent any sideways motion of the key. The pins will be found in

the original keyboard assembly and can usually be pulled right out with a pair of strong pipe pliers. Each key must be held in place, the hole in the brass bar drilled and threaded, the key fastened to that, then the guide pin position marked. Drill a hole for each guide pin, then push it in place. When the keys are mounted permanently, a pair of small rubber grommets are slipped over each pin so the keys will hit bottom without a thud and will not go down too far.

After all the keys are mounted and working mechanically, detach them one by one and mark the contact board to show the area covered by the metal strip under each key where the contact springs will be located.

The contact springs used in the original model were cut down from copper motor brush springs obtainable at motor repair shops. A hole was drilled through the contact board at each spring location and the spring held down with a round-head machine screw. Small solder lugs were placed between the nut and the board underneath. Quarters are close, so careful measurement is necessary.

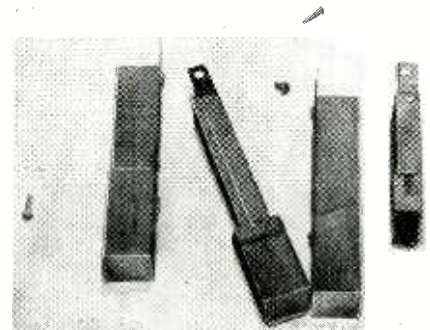
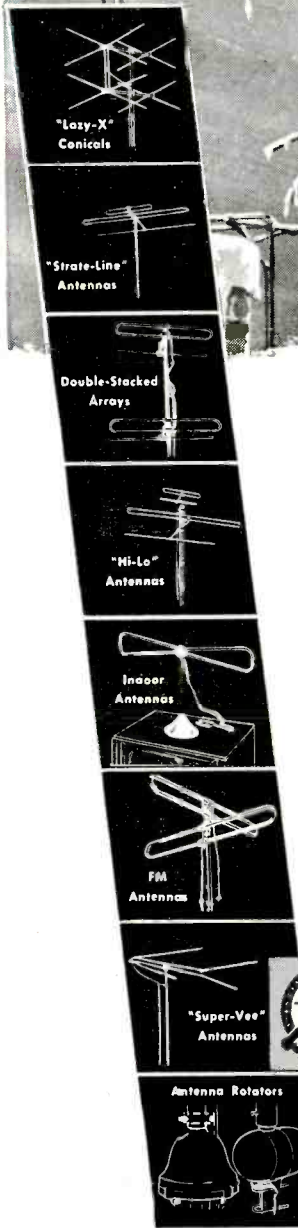
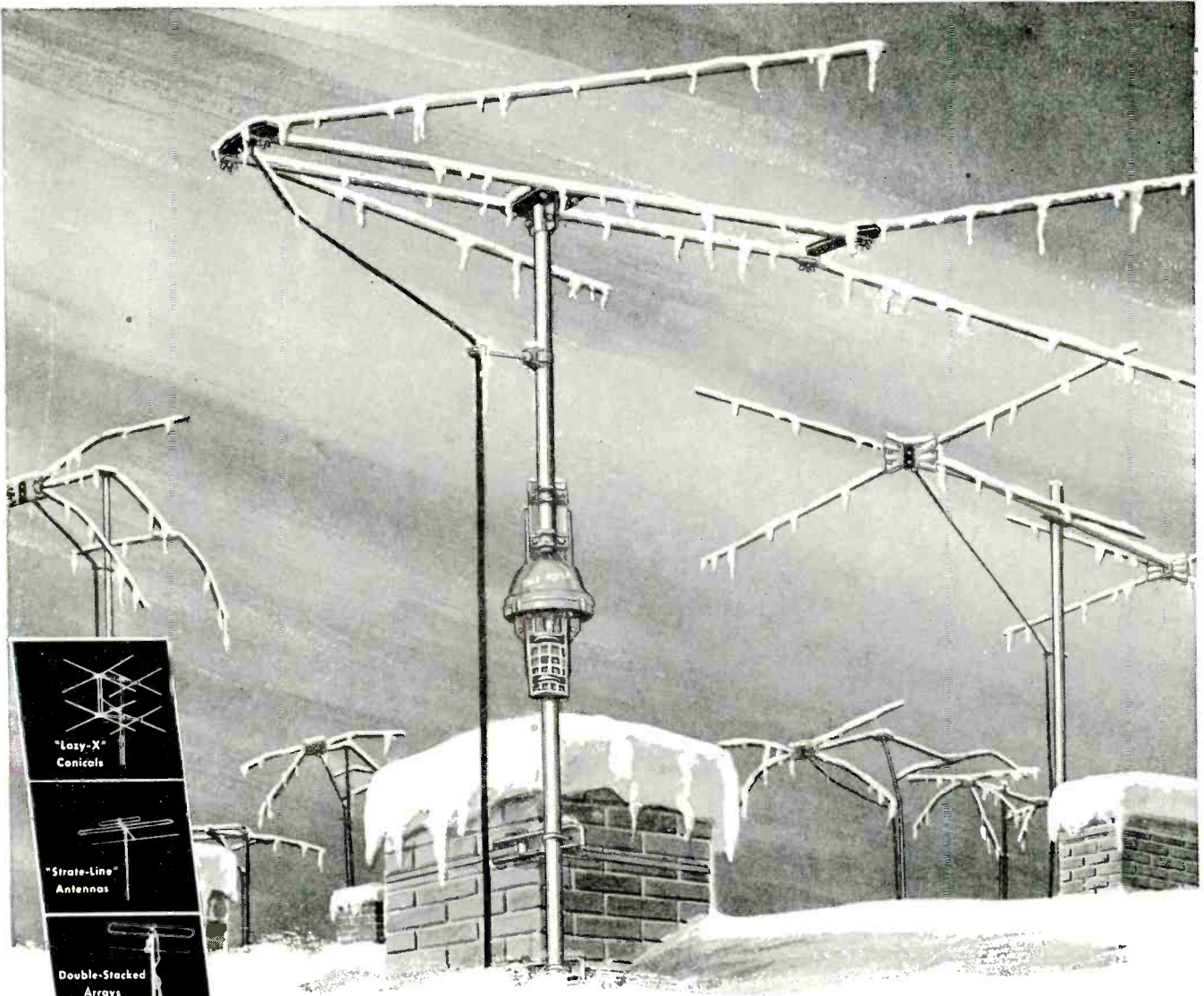

Photo C—Springy metal strips fitted to the keys return them to rest position and make electrical contact to the four metal springs mounted below them.



When It's Needed the Most...

RADIART Quality Meets the Challenge

TELEVISION viewers expect a crystal clear picture always... in fair weather or foul! The antenna installation must be secure... and the antenna itself rugged far beyond ordinary requirements. Storms mean little in the life of a RADIART antenna. Recent severe winter weather wrecked havoc with many, many antennas... but not so with RADIART! Layers of ice and snow... winds of gale proportions... BUT NOT A SINGLE CASE OF DAMAGE DUE TO INFERIOR DESIGN OR QUALITY WAS REPORTED ON RADIART ANTENNAS. This is even further proof of RADIART superiority. AND, performance-wise... their superb engineering design delivers the ultimate in performance. Again... RADIART quality meets the challenge!



SUBSIDIARY OF



THE RADIART CORPORATION CLEVELAND 2, OHIO

VIBRATORS • AUTO AERIALS • TV ANTENNAS • ROTATORS • POWER SUPPLIES

Learn Circuits from
A to Z... and Watch Service
Troubles Disappear!

Read This
**NEW GHIRARDI
BOOK FOR 10
DAYS at our risk!**



A. A. GHIRARDI

Here—just out—is the latest and greatest of the famous A. A. Ghirardi books, "RADIO AND TELEVISION RECEIVER CIRCUITRY AND OPERATION"! Actually, despite the many circuit variations, there are only a few really basic circuits in modern radio, FM and television receivers. Let this big, illustrated book teach you all about these—and you'll be able to handle all types of service faster, better and more profitably.

**HANDLE TOUGH JOBS IN 1/2
THE USUAL TIME!**

Starting with a clear explanation of AM and FM, RADIO AND TELEVISION RECEIVER CIRCUITRY AND OPERATION then progresses to a complete understanding of ALL basic circuits. You learn how each circuit operates—what it consists of—how to recognize it quickly—how to trace troubles with a minimum of laborious testing—how to make repairs promptly. By making it easy for you to understand each circuit and its relation to other circuits, this great book helps you go right to the seat of the trouble with far less time and effort. It speeds up your work. It makes it easy to understand new receivers—to know just how they function and how to service them quickly and accurately.

NO OTHER BOOK LIKE IT!

Prepare yourself for bigger jobs, better pay! Send coupon today. Read this great book for 10 full days under our MONEY-BACK GUARANTEE offer.

10 DAY MONEY-BACK GUARANTEE

Dept. RE-41, Rinehart Books, Inc.
Technical Division

232 Madison Ave., New York 16, N. Y.

Enclosed find \$6 for A. A. Ghirardi's new RADIO AND TELEVISION RECEIVER CIRCUITRY AND OPERATION book; or send C.O.D. and I will pay postman this amount plus postage. If book is not satisfactory, I will return it after 10 days and you guarantee to refund my \$6. (Price \$6.50 cash only outside U.S.A.—same return privilege)

Name _____

Address _____

City, Zone, State _____

The keys must be remounted next, and the contact springs adjusted by bending, pulling, and cutting them off, so that an ohmmeter shows positive contact when the key is pressed and no contact when it is released. The key mask (piece K in Fig. 1) should be mounted before the final ohmmeter check is ended.

One very important point is to adjust the springs so that with each key the rearmost spring is not contacted until the key hits almost the very bottom. This spring controls the keying of the output stage; that stage should remain inoperative until all the tuning contacts have

ply bleeder, but do not place this so far up that the OD3 does not glow. The 5,000-ohm, 10-watt series regulator resistor also requires adjustment for this purpose; if the supply voltage is low, it will probably have to be shorted out entirely. If attack characteristics are not perfect, experimenting with all the resistors and capacitors of the delay network at the center-tap of the interstage transformer will supply the answer. The arm of the present 100,000-ohm potentiometer may have to be moved down to prevent the audio tone from overriding the cutoff bias on the final stage with the key up.

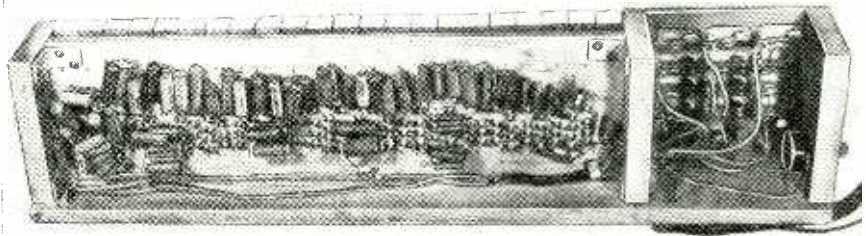

Photo D—The keyboard unit with bottom cover removed. The compartment at right contains the stop buttons; the capacitors at left tune the three ranges.

been made and should cut off again before any tuning contacts are broken.

Before going back to the chassis, the stop buttons may be mounted on a thin board (piece H in Fig. 1). The cable leading to the chassis should be made up. It consists of 20 shielded wires bound together with Scotch electrical tape and terminated in a 20-prong male Amphenol connector. Numbered connections are indicated in last month's Fig. 3. The keying (pin 3) and ground (pin 20) leads may be connected to the terminal lugs under the springs as indicated in that diagram. For that purpose, all rear contact springs are connected together. The cable comes out of the rear in the right-hand compartment, as shown in Photo D.

Chassis assembly

The construction of the chassis assembly as indicated in last month's photos and diagrams and in this month's Photo A is next on the agenda. Begin by wiring all the filaments. Then complete the 8-foot generator and its amplifier (but *not* the synchronizing connection from the plate of the amplifier to the grid of the 16-foot 884), the 8-foot flute stop filter, the 6SJ7 and 1/2 6SN7-GT voltage amplifiers, and the 6G6-G output stage. Short out the expression pedal receptacle SO-2, and plug a speaker into the phone jack.

In the keyboard unit, wire temporarily the first 8-foot tuning capacitor, using the .008- μ f value shown in last month's Fig. 3. Now, when the lowest key is pressed, some tone should be heard in the speaker. Wire up the vibrato circuit and test it. Press the key several times to see that there are no clicks or pops. If there are, or if there is too much delay in tone buildup, experiment with the tap on the 8,000-ohm, 25-watt section of the power sup-

ply bleeder, but do not connect amplifier plates to 884 grids for synchronization. One each of the 16- and 32-foot filters also may be wired.

The next step is to tune the 8-foot range. The capacitor values suggested in last month's Fig. 3 are not exact and will vary with different 884's. It is simply a matter of having a good stock of capacitors on hand and substituting for each note until the right value is found.

Begin with the lowest note. It is essential to have a piano or a well-tuned organ for this job, and not the least of the required equipment is a good ear. As the correct capacitor is found for each pitch, wire it in place and proceed to the next note. Every few minutes, recheck the pitches of the preceding ones, readjusting the main tuning control if necessary. There will not be significant drift while the Thyra-tone is in operation, but the initial tuning should be very exact, which is why any drift at all should be corrected.

After tuning the 8-foot generator throughout the range, tune the 16-foot generator. Pull the 16-foot stop which has been wired and select the capacitor value which, when the lowest key is pressed, will tune the 16-foot generator to a shade *lower* than an octave below middle C. Then connect temporarily a 1-megohm potentiometer (in series with a .0025- μ f capacitor) between the plate of the 8-foot amplifier and the grid of the 16-foot generator. Pressing the lowest key, reduce the resistance until the tone just pops into synchronism and hits the C exactly. Now press the next keys up through F, each time reducing the resistance until the 16- and 8-foot tones synchronize an octave apart. In each case, recheck the lower tones to see that they are still where they should be.



in the southeast
RELIABILITY

sold
2215 EXPERTS

renew
with **N.U.**

premium quality tubes

SAYS BILL GRIGSBY

Southeastern Radio Parts Co.

Georgia: Atlanta, Savannah

Alabama: Montgomery

South Carolina: Columbia

We don't guess when we stock tubes. We meet the demand of our 2,215 Servicemen and Service Dealers who have made N. U. tubes their first choice. These experts know from actual experience that N. U. tubes meet the strictest service requirements... that N. U. tubes are uniform, reliable, properly designed for interchangeability. The confidence of our customers in N. U.'s quality control and advanced research makes N. U. tubes profit-makers for all of us.

- **RADIO and TELEVISION RECEIVING TUBES**
- **VIDEOTRON TELEVISION PICTURE TUBES**
- **PANEL LAMPS**
- **TRANSMITTING and SPECIAL PURPOSE TUBES**



NATIONAL UNION RADIO CORP.

Main Office: 350 Scotland Rd., Orange, N. J.

Research Division: Orange, N. J. Plants: Newark, N. J. - Hatboro, Pa.

American Beauty
ELECTRIC SOLDERING IRONS
for the most
RUGGED or
DELICATE
Jobs

USED THROUGHOUT
 THE WORLD FOR
 MORE THAN
 A HALF
 CENTURY

5
 SIZES

from 50 Watts
 to 550 Watts

**THERMO-
 STATICALLY
 CONTROLLED
 TEMPERATURE
 REGULATING
 STAND**

● A device for regulating the heat of an electric soldering iron while at rest—Thermostat may be set to maintain iron at working temperature, ready for instant use, or at a lower heat.



**AMERICAN ELECTRICAL
 HEATER COMPANY**
 DETROIT 2, MICHIGAN
 established 1894

It may or may not be possible, depending on the tubes and the wiring, to go as far as F with one resistance value keeping all tones in sync. If not, stop at a lower note. Insert a fixed resistor and go on to the next group of notes in the same way. Tuning the 32-foot range duplicates the same process. When it is finished, pushing any key should produce three octavely related notes. The one or ones heard will depend on the stop buttons pulled.

The rest of the filters may now be wired up. There is an opportunity for the individual to express himself here, for by experimenting with values the

made to turn the pad through its full rotation, that is not ideal, since the pedal should not be allowed to cut volume down to zero. Selecting a knob with the correct diameter is the easiest way to control the amount of total rotation.

Modifications

The Thyratone, as described in these two articles, is an experimental instrument. While it was first designed on paper, many changes were made during the course of construction and there is no doubt that ingenious constructors will have many more excellent ideas to

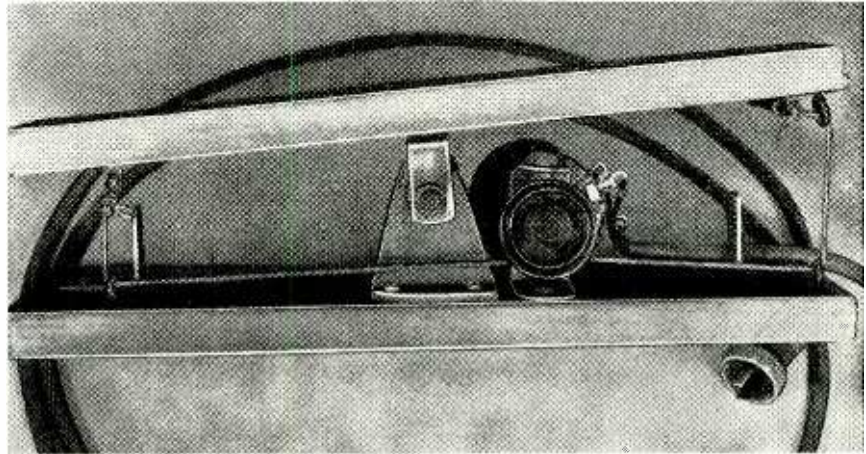

Photo E—View of the expression pedal. A cable connects it to the main chassis.

tone quality of each stop can be altered to suit a whim. The ones shown in last month's Fig. 2 use values found in W. E. Kock's Patent No. 2,233,948 and are fairly well imitative of the organ stop qualities with which they are labelled. The woodwind stops really should be fed square waves, as is provided in the patent, but we have not bothered with that in the Thyratone. The inductors in the filters were made by removing cores and windings from old audio chokes and transformers and checking values with a bridge. For less exact results, the same thing can be done by ear.

In the keyboard unit, the hollow brass bar acts as the common ground connection so that when a key is pressed the strip of metal under it grounds all four contact springs.

Expression pedal

Photo E is a side view of the expression pedal. It consists principally of two pieces of wood 4 x 10 inches and 1/2 inch thick. A pair of angles attached to the center outside of each and a threaded 1/4-inch bar going through all four pivot it. A wire-wound, 8-ohm T-pad is mounted on an angle on the bottom piece and is turned by a string-pulley arrangement with screw-eyes. Three turns of the string around the knob is sufficient, but one end of the string arrangement should be terminated in a spring to keep tension fairly constant. A pair of angles at the ends of the bottom board provide stops to prevent the pedal from being pushed too far in either direction.

Though this arrangement can be

contribute to their own versions.

One good idea, for example, might be to alter the keyboard unit so as to place in it the tone generators. This would eliminate a healthy amount of wire and make for less cross-talk.

Addition of the "woodwind device" explained in the Kock patent would add to the realism of the woodwind tones.

There is a slight amount of gliding when a key is pressed; that is, the tone is not sounded squarely but slides up to pitch. That is caused by the use of a thyratron as a master oscillator, and it could be eliminated (and stability improved) by using some other kind of oscillator for at least the 8-foot range. For good tone shaping with the Kock system, however, the oscillator should provide a sawtooth waveform.

A separate tube for the triode amplifier which follows the 6SJ7 probably would help to eliminate cross-talk.

The present design, in any case, does give the electronic music designer a few interesting ideas and certainly provides a satisfying solo musical instrument. Since the stops are imitative of existing acoustic instruments and can be used individually or in any desired combination, a very large range of tone qualities is available to prevent the listener and player from tiring of the sound. It does, of course, sound rather "electronic" because each pitch is so steady, without the minute, random waverings caused in acoustic instruments by variations of air pressure and swelling of sound cavities. Later in this series methods of overcoming the "electronic-ness" of many such instruments will be discussed. —END—

A REAL AUTOMATIC PHONO

Many of the newer record changers have an automatic switch which cuts off the motor after the last record has played. Thus you are spared the weary repetition of the last record on the stack. The automatic shutoff feature is a big improvement over older changers but its major advantage is that the changers can be readily adapted to automatically switch the set from phono to radio at the end of a stack of records. The service technician will find it somewhat simpler to add these changers to sets which do not have a record player because he does not have the problem of finding a satisfactory spot to install a phono-radio switch. The diagram shows how the changer is connected.

An inexpensive d.p.d.t., 117-volt, a.c. relay replaces the usual radio-phono switch. Its coil is wired so the armature pulls in when the phono motor is turned on. The contacts silence the radio and connect the pickup to the audio amplifier in the set.

The audio leads should be shielded and kept as short as possible to avoid hum pickup from the r.f. In this circuit, we ground the audio line from the second detector. Other technicians may prefer to cut the screen or plate voltages to the r.f. and i.f. sections of the set while records are being played.

With the relay installed, just load the changer and turn on the motor. The relay switches the circuits and the records are played in order. After the last record has played, the motor shuts off and your favorite radio station comes in automatically.—L. Earl Jones, W7JCC

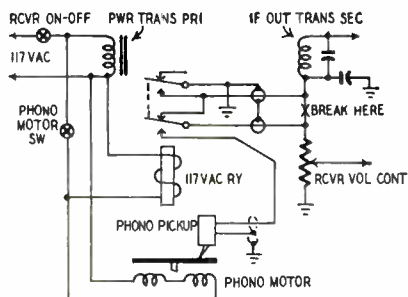

AUDIO FEEDBACK DESIGN

We regret the omission of "Audio Feedback Design" from this issue. Mr. Cooper's manuscript—which comes to us from Scandinavia—was delayed in transit, and arrived too late to be included. It will appear in the May issue of RADIO-ELECTRONICS, and the series will continue as usual.

Readers may be interested to know that Mr. Cooper's subject for the installment is the use of positive feedback in audio amplifiers. He shows that positive feedback, if properly applied, will give a marked reduction in amplifier distortion for a given gain. He also describes how this type of feedback can be included in an amplifier circuit and how it can be used to bring about a saving in components.

Valuable guides for television technicians

Just published!
MOVIES FOR TV



This complete, practical book gives you all the information you need to choose the best equipment, operate it most efficiently, and make the most effective use of movies on TV programs. It explains the operation of all leading makes of cameras, projectors, sound and kinescope recording equipment, different types of lenses, etc., giving the advantages, disadvantages, and relative costs of each. It shows what may go wrong and how to avoid trouble, what type of picture is good on television and what is not, how to light movies for best TV reception, how to insure good shots on location, combine live scenes with movies, produce special effects, titles, newsreels, different types of commercials, and much else that will be of utmost practical aid to station personnel and program planners. *By J. H. Battison.*

A practical how-to-do-it guide for technician and program director alike.

TELEVISION & FM ANTENNA GUIDE



This excellent handbook will save you much testing and readjusting and insure the best reception from any antenna system. It gives you the characteristics, dimensions, advantages and disadvantages of all VHF and UHF antennas and allied equipment, including heretofore unpublished information on new types recently tested by the authors. It tells how to determine the right type of antenna for a specific location, locate space loops, determine signal strength, etc.; how to mount various types of antennas on different kinds of roofs or window sills; how to minimize noise and avoid standing waves in transmission lines, and all other installation procedures. Handy tables give comparative data, and there is full, clear instruction in all fundamental antenna principles. *By Noll & Mandl.*

How to get the most out of the antenna system at any location.

Outstandingly helpful references

TELEVISION FOR RADIOMEN

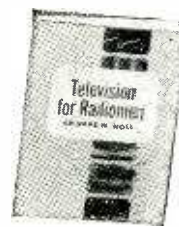

The outstanding book on television for servicemen. Explains in clear, non-mathematical terms the operating principles and function of every part and circuit in today's TV receivers, and the chief principles of transmission. Complete, practical instruction in installation and alignment procedures, testing equipment and how to use it, adjustment, and trouble-shooting. *By E. M. Noll.*

RADIO & TELEVISION MATHEMATICS



This unique handbook of 721 problems and solutions shows you what formulas to use, what numerical values to substitute, and each step in solving any problem you are likely to encounter in radio, television, or industrial electronics. Conveniently arranged and fully indexed for quick reference. *By Bernhard Fischer.*

USE THIS COUPON
to get FREE examination copies. If you're not fully satisfied, you may return them without further charge.

The Macmillan Company, 60 Fifth Avenue, New York 11

Movies for TV \$4.25
 Television & FM Antenna-Guide. \$5.50
 Television for Radiomen \$7.00
 Radio & Television Mathematics \$6.00

Please send me the books checked. I will either remit in full or return the books in 10 days.

Signed

Address

New Printed Circuits Make for Compactness

By H. E. MOORE*

THE printed circuit technique, first used by early experimenters who applied carbon ink on an insulating surface to make crude resistors even before the day of Edison and De Forest, was discarded in favor of fixed carbon resistors because of the instability of the carbon ink deposits. Early superregenerative radio receivers used a high-resistance grid resistor made simply by a carbon lead pencil mark across an insulated surface. This early printed circuit could be controlled, within limits, by building up carbon for less resistance and erasing part of it for more. To get the proper resistance value, a certain amount of "cut and try" was necessary. This resistor was not constant in value for any appreciable time.

In 1925, the first graphite-type volume control was developed, using the printed technique, spraying or depositing through a screen or mask a controlled amount of carbon. This volume control was the forerunner of today's carbon-type volume controls and potentiometers rated under 2 watts. These early developments were the basis for

the modern printed circuit network.

At the beginning of the last war the armed forces needed a circuit that would fit in the nose of small caliber shell, yet was rugged enough to withstand the shock of firing. Centralab, Division of Globe-Union, Inc., working closely with the National Bureau of Standards, Ordnance Division, solved this problem with a circuit using no conventional components. The wires were silver paths printed on a steatite base. Resistors were carbon elements printed directly to the base and connecting the silver wires. Capacitors made of thin wafers of high dielectric ceramic, silver-coated on both sides to get capacitance, were sweat-soldered directly to the silver path. The result was a complete, one-piece circuit with practically no third dimension-thickness.

The complete printed circuit was first used commercially in small, lightweight hearing aids. One of the pioneers, the Allen-Howe Co., began using a three-stage resistance-coupled amplifier, measuring $1\frac{1}{8} \times 2\frac{1}{4} \times \frac{3}{32}$ inches. The latest models of this standard circuit now measure $1\frac{1}{8} \times 1\frac{1}{4} \times .340$ inch. Such a circuit is shown in Photo A. At the present time, 90% of all hearing-aid manufacturers use printed circuits

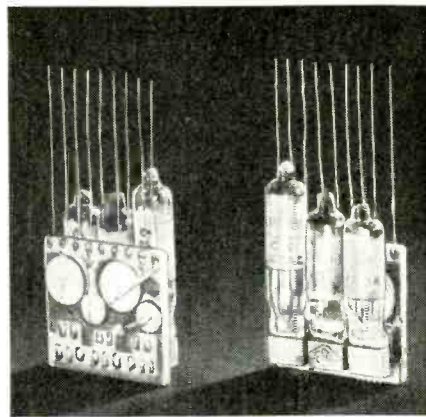

Photo A—A printed-circuit hearing-aid.

in one form or another in the production of very powerful subminiature amplifiers.

The only limitation to the power output of these small amplifiers is the subminiature tubes designed for this

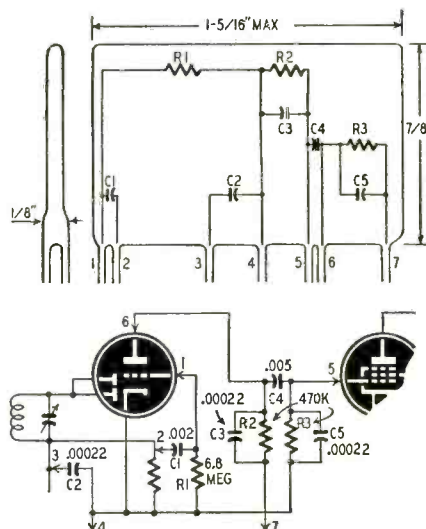
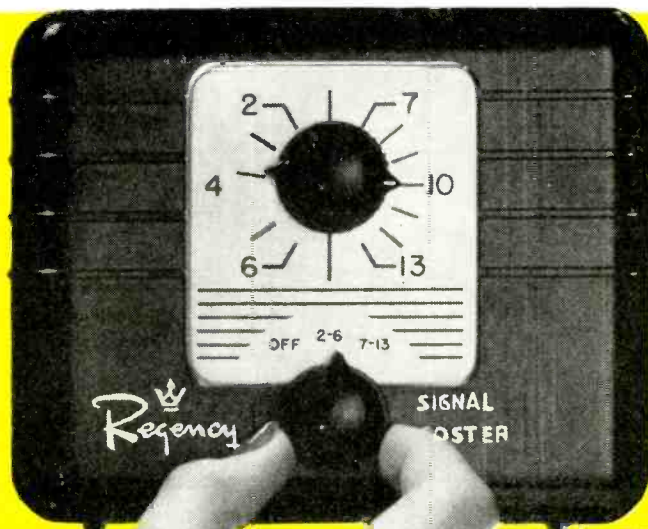

Fig. 1—An R-C audio coupling network.

*Capacitor and Printed Circuits Division, Centralab, Milwaukee, Wisc.

Largest Selling Booster

AT ANY PRICE !



Regency

application. At present subminiature tubes are available from Raytheon, type CK518, rated at 9.5 milliwatts. The common hearing aids use output tube type CK525, rated at 2.2 milliwatts.

Several different types of printed circuit are in use today. One type, used in television tuners and developed by RCA and Standard Coil Products, utilizes a 2-mil copper plate on a phenolic or plastic plate photo-etched to a specially designed circuit pattern. The tie points or connections are riveted to the plate and the entire plate is dipped in solder to obtain the final circuit. A modification of this process using grooved plates was originally used by John Sargrove, Ltd., London, England, (See RADIO-CRAFT, September, 1947) to mass-produce small radio receiver circuits.

Printed plates

The latest development—and one of the most promising—is the use of high dielectric constant plates with a printed silver pattern controlling the capacitor values and having resistors deposited to form the complete circuit on a single plate. These plate circuits are used by most television and radio manufacturers not so much because of their small size, but because they represent a saving in manufacturing cost.

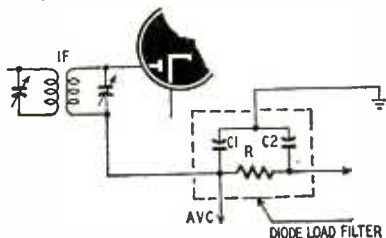

Fig. 2—Circuit of a Filpec diode filter.

These plates often improve electrical performance over standard wired components, as well as simplify assembly connection. Their greatest value is in replacing conventional resistors and capacitors making up a "common" circuit. A common circuit, for the purpose of this article, is one that is standardized and used by practically all manufacturers as the best combination of resistors and capacitors for a particular function in a radio or television set. A good example of a common circuit is

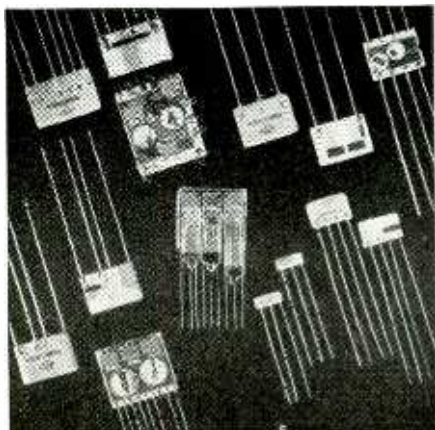
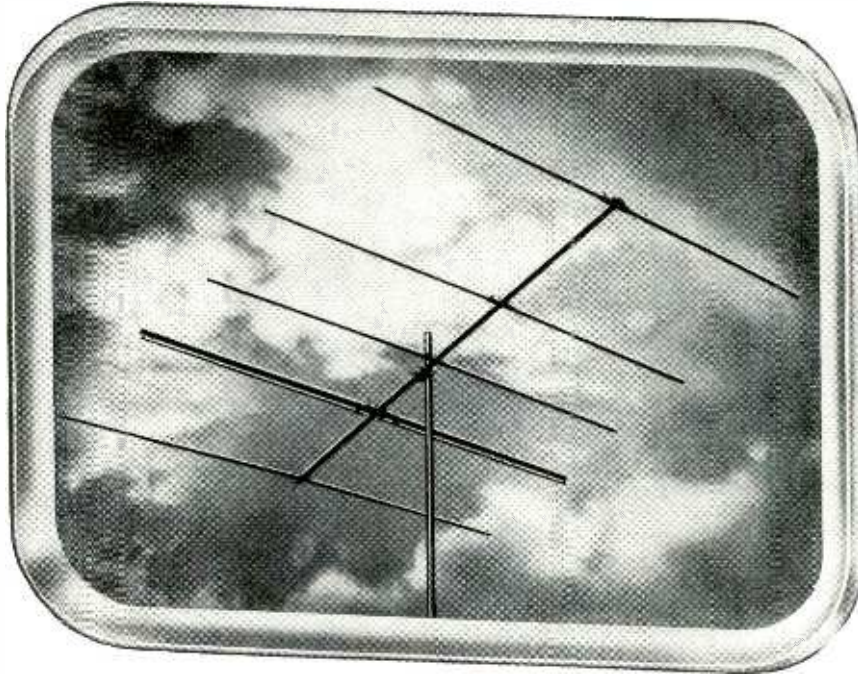

Photo B—A few of the many PEC plates.

APRIL, 1951

**OFTEN COPIED
— NEVER EQUALED**



**The One and Only
VEE-D-X "JC" YAGI**

The Vee-D-X "JC" is by far the world's most popular Yagi. It outperforms and outsells all others. It is the pioneer pre-assembled Yagi — and still by far the best. Provides powerful signal at lowest cost . . . with minimum installation time. Why accept inferior copies when you can get the one and only "JC" Yagi?

**HERE IS YOUR GUIDE TO THE
WORLD'S FINEST ANTENNA SYSTEMS**

It's the big new 1951 VEE-D-X catalog — a single source for all antenna requirements. For your copy write to The LaPointe-Plascomold Corp., Windsor Locks, Connecticut.



VEE-D-X

THE WORLD'S MOST POWERFUL ANTENNAS

the television vertical integrator plate consisting of a bridge network of three resistors and three capacitors. Only three external wire leads connect to the plate, yet 10 solder connections are eliminated by this plate. This vertical integrator will operate satisfactorily in any television receiver even though the television set has not been designed for this plate, or if the components previously specified are of different values. Photo B shows a number of such plates.

Other circuits presently manufactured are the triode and pentode audio "Couplate", a triode and pentode interstage coupling network. (Fig. 1); the "Audet", an audio-detector-coupler network common to most a.c.-d.c. receivers;

and a diode load filter called "Filpec" (Fig. 2).

Printed circuits offer several advantages over conventional circuits in addition to their smaller size:

Being ceramic, the dielectric does not deteriorate. It is basically impervious to moisture and humidity, and, in addition, the circuit is coated with Bakelite resins and is vacuum wax impregnated to prevent surface moisture from changing the electrical characteristics.

The PEC (Printed Electronic Circuit) can be operated to maximum voltage and temperature without any loss in electrical characteristics with age.

Few soldered connections are needed when using the PEC in the completed

assembly. This lessens the chance of equipment failure due to cold solder joints, improper wiring, capacitance coupling between components, and other troubles common to electronic circuits.

Printed circuit amplifiers and plates can be assembled of matched components. This matching of capacitors and resistors allows a circuit to be made on the basis of performance in the application for which it is designed, thus eliminating the need for matching relatively wide tolerance components, as in conventional wired circuits, and then hoping that the performance will be "good enough".

The printed connections are short, thus providing excellent high-frequency performance. Change in lead inductance and capacitance is prevented as the leads are bonded directly to steatite.

Tolerances

Resistors used in PEC are presently available rated as high as 50 megohms with a stability and noise level comparable to the best composition resistors on the market today. The standard load ratings vary between $\frac{1}{10}$ and $\frac{1}{8}$ watt. The resistance tolerance is $\pm 20\%$.

The capacitance rating and the number of capacitors in the circuit controls the size of the PEC amplifier or allied circuit. Capacitors of 5,000 μf require an area $\frac{3}{8}$ inch in diameter. Capacitors below 1,500 μf require an area $\frac{1}{4}$ inch in diameter. The standard capacitance tolerance, except when matched in a circuit is $+80\%$ -20% for capacitance greater than 1,000 μf . For this value, and below, the tolerance is $+50\%$ -20% .

As a rule of thumb, the design of a PEC amplifier can be laid out, using the above design constants, by determining the capacitance area and then multiplying this value by two to obtain the complete plate area.

Printed inductance coils are practical for circuits involving frequencies above 25 megacycles. Inductance measuring up to 0.1 mh is presently being manufactured and higher values are available for specific requirements.

The PEC industry is relatively undeveloped and the future is wide open. It is conceivable that complete radio receivers will be only as large as the speaker and tubes, the chassis being a plug-in unit similar in size to a present-day tube, which can as easily be replaced if any defect develops. Television sets will be produced in which complete i.f. stages are removed and tested much as tubes are today.

In the v.h.f. range of tomorrow's television and commercial and citizens radio, printed circuits will have wide application because it is only by use of fixed, low-inductance wiring that frequency drift can be controlled and signal strength maintained. We have come a long way from the early experimenter who drew grid leak resistors with a lead pencil. The remarkable possibilities of printed circuits are just beginning to be realized, and for the future the sky is the limit.

—END—

RADIO-ELECTRONICS for



Yes, the revolutionary new TRIO TV Yagi — the only yagi that provides 10 DB gain on each of two channels — is America's most wanted antenna in weak signal areas.

This lightweight, compact array, which gives metropolitan quality TV reception in fringe areas, is available for channels 4 and 5 in the low band, and channels 7 and 9 in the high band.

OUTSTANDING FEATURES

- Provides gain on both channel 4 and 5 (or 7 and 9). Equal to any two conventional 4-element yagis!
- One bay replaces bulky stacked array!
- One lead replaces old-style 2-lead systems!
- Less weight-per-gain than any other TV antenna!
- Greatly reduced installation costs for complete TV coverage!
- Can be stacked for additional gain.

HOW IT WORKS

Antenna consists of 4 elements whose function is different on the two channels. In Model 445, the elements, on Channel 4, act as reflector, dipole, director, director, in that order. On Channel 5, the same elements act as reflector, reflector, dipole and director. Careful design insures proper impedance match with standard 300ohm lead.

Eliminates Co-Channel Interference - Venetian Blind Effect . . . When Used With Trio "Controlled Pattern" System

This unique, "Controlled Pattern" system uses 2 bays, off-set stacked and tuned with the remarkable TRIO "Phasitron". High gain and front to back ratio of the new single or stacked yagi eliminates most co-channel interference.

When the TV receiver is located in the center of several TV stations operating on the same channel, co-channel interference CAN BE COMPLETELY eliminated with the use of the "Controlled Pattern" system.

When other antennas fail, try TRIO — America's MOST WANTED TV Antenna!

- Model 445 - Single bay Yagi for Channels 4 and 5.
- Model 445-2 - Conventional 2 bay stacked array for Channels 4 and 5.
- Model 479 - Single bay Yagi for Channels 7 and 9.
- Model 479-2 - Conventional 2 bay stacked array for Channels 7 and 9.
- Model 645 - "Controlled Pattern" System for Channels 4 and 5, and Model 679 for Channels 7 and 9.



Single 4-element yagi with dual purpose elements. Provides high gain on two channels.



Two of the new TRIO yagis may be stacked to get up to 12 DB forward gain.

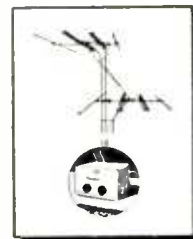

The "Controlled Pattern" System—eliminates "Venetian-Blind effect" when caused by co-channel interference.



IN TUNE WITH THE TUNER!

NEW...IMPROVED

"STANDARD TV BOOSTER"

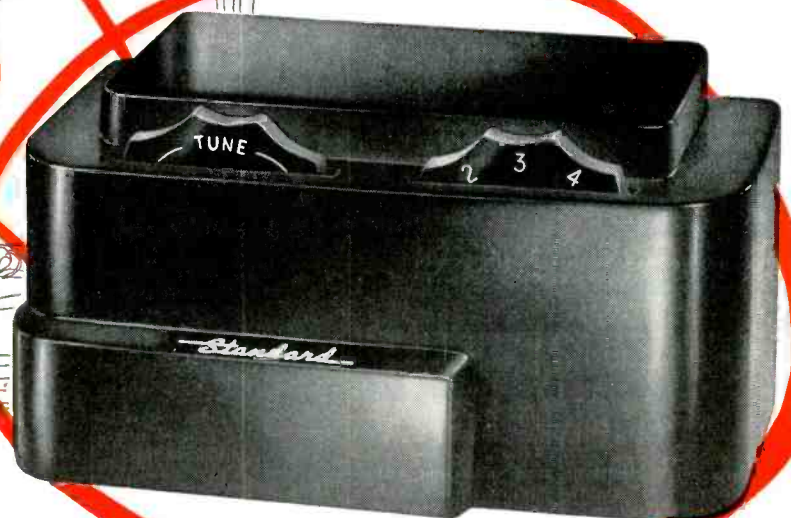
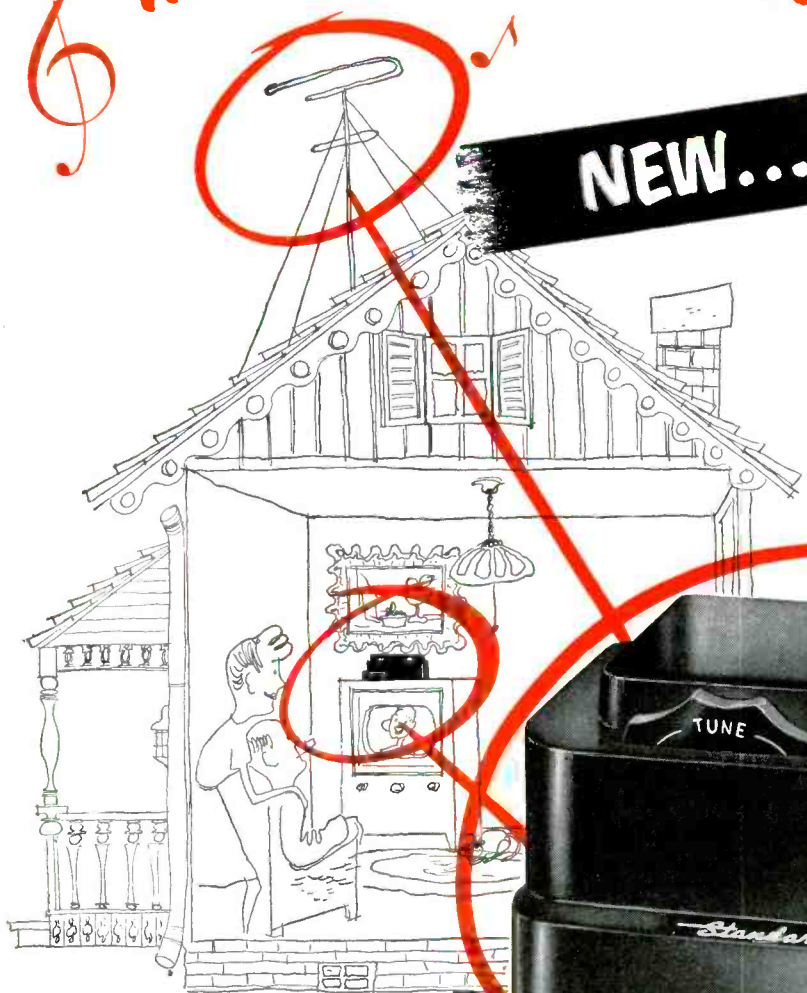

MODEL B-51

Millions of "Standard Tuners"

Now In Use

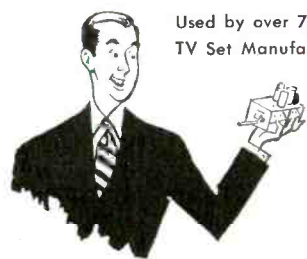

Used by over 75 TV Set Manufacturers

The new "Standard Booster" will increase the TV signal strength to a degree that will make possible "city" reception in areas remote from the TV transmitter. It reduces the "snow" or noise and interference to give a clearer, sharper picture and improved sound reception. It also makes possible receiving a picture in very remote areas or "blind" areas in close-to-transmitter locations where the TV set alone will not — makes a TV set a real enjoyment!

Standard COIL PRODUCTS CO. INC.
CHICAGO • LOS ANGELES • BANGOR, MICH.



SUPERIOR'S
new model 770 **AN ACCURATE POCKET-SIZE**
VOLT-OHM MILLIAMMETER
(SENSITIVITY: 1000 OHMS PER VOLT)

FEATURES

- ★ Compact-measure 3 1/8" x 5 7/8" x 2 1/4".
- ★ Uses latest design 2% accurate 1 Mil. D'Arsonval type meter.
- ★ Same zero adjustment holds for both resistance ranges. It is not necessary to readjust when switching from one resistance range to another. This is an important time-saving feature never before included in a V.O.M. in this price range.

★ Housed in round-cornered, milled case.

★ Beautiful black etched panel. Depressed letters filled with permanent white, insures long-life even with constant use.

The Model 770 comes complete with self-contained batteries, test leads and all operating instructions.

SPECIFICATIONS

6 A.C. VOLTAGE RANGES:
0—15/30/150/300/1500/3000 VOLTS

4 D.C. CURRENT RANGES:
0—1.5/15/150 MA. 0—1.5 AMPS.

6 D.C. VOLTAGE RANGES:
0—7.5/15/75/150/750/1500 VOLTS

2 RESISTANCE RANGES:
0—500 OHMS 0—1 MEGOHM

\$14⁹⁰
NET

Superior's new model 670

SUPER-METER

A COMBINATION VOLT-OHM MILLIAMMETER PLUS CAPACITY REACTANCE
INDUCTANCE AND DECIBEL MEASUREMENTS

SPECIFICATIONS:

D.C. VOLTS: 0 to 7.5/15/75/150/750/1,500/7,500 Volts
A.C. VOLTS: 0 to 15/30/150/300/1,500/3,000 Volts
OUTPUT VOLTS: 0 to 15/30/150/300/1,500/3,000 Volts
D.C. CURRENT: 0 to 1.5/15/150 Ma. 0 to 1.5 Amperes
RESISTANCE: 0 to 500/100,000 Ohms 0 to 10 Megohms
CAPACITY: .001 to .2 Mfd. .1 to 4 Mfd. (Quality test for electrolytics)
REACTANCE: 700 to 27,000 Ohms 13,000 Ohms to 3 Megohms
INDUCTANCE: 1.75 to 70 Henries 35 to 8,000 Henries
DECIBELS: -10 to +18 +10 to +38 +30 to +58

ADDED FEATURE:

The Model 670 includes a special GOOD-BAD scale for checking the quality of electrolytic condensers at a test potential of 150 Volts.

The Model 670 comes housed in a rugged, crackle-finished steel cabinet complete with test leads and operating instructions. Size 5 1/2" x 7 1/2" x 3".

\$28⁴⁰
NET



The New
Model 200

AM and FM SIGNAL GENERATOR

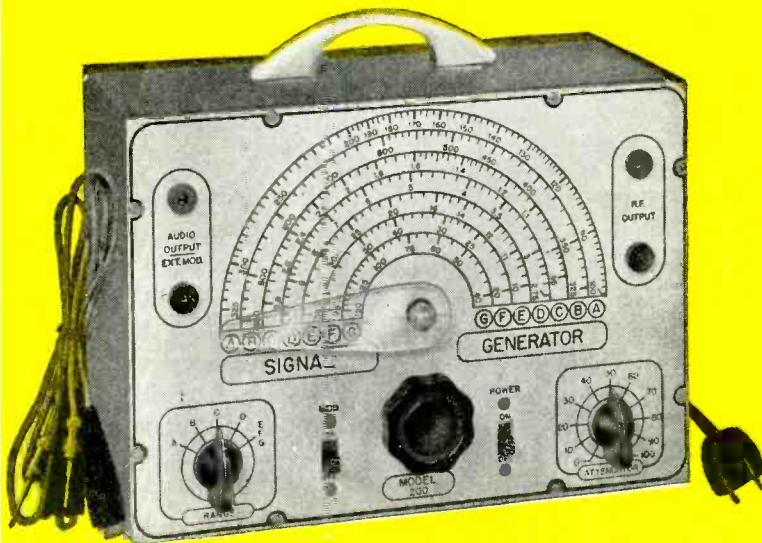
**SPECIFICATIONS**

- ★ **R.F. FREQUENCY RANGES:** 100 Kilocycles to 150 Megacycles.
- ★ **MODULATING FREQUENCY:** 400 Cycles. May be used for modulating the R.F. signal. Also available separately.
- ★ **ATTENUATION:** The constant impedance attenuator is isolated from the oscillating circuit by the buffer tube. Output impedance of this model is only 100 ohms. This low impedance reduces losses in the output cable.
- ★ **OSCILLATORY CIRCUIT:** Hartley oscillator with cathode follower buffer tube. Frequency stability is assured by modulating the buffer tube.
- ★ **ACCURACY:** Use of high-Q permeability tuned coils adjusted against 1/10th of 1% standards assures an accuracy of 1% on all ranges from 100 Kilocycles to 10 Megacycles and an accuracy of 2% on the higher frequencies.
- ★ **TUBES USED:** 12AU7—One section is used as oscillator and the second is modulated cathode follower. T-2 is used as modulator. 6C4 is used as rectifier.

The Model 200 operates on 110 Volts A.C. Comes complete with output cable and operating instructions.

\$21⁸⁵
NET

USE CONVENIENT RUSH ORDER FORM ON OPPOSITE PAGE

GENERAL ELECTRONIC DISTRIBUTING CO. DEPT. RG-4, 98 PARK PLACE
NEW YORK 7, N. Y.

Superior's New Model TV-11

TUBE TESTER



Specifications

- Tests all tubes including 4, 5, 6, 7, Octal, Lock-in, Peanut, Bantam, Hearing-aid, Thyatron, Miniatures, Sub-Miniatures, Novals, Sub-Minars, Proximity Fuse Types, etc.
- Tests for "shorts" and "leakages" up to 5 Megohms.
- Uses the new self-cleaning Lever Action Switches for individual element testing. Because all elements are numbered according to pin-number in the RMA base numbering system, the user can instantly identify which element is under test. Tubes having tapped filaments and tubes with filaments terminating in more than one pin are truly tested with the Model TV-11 as any of the pins may be placed in the neutral position when necessary.
- The Model TV-11 does not use any combination type sockets. Instead individual sockets are used for each type of tube. Thus it is impossible to damage a tube by inserting it in the wrong socket.
- Free-moving built-in roll chart provides complete data for all tubes.
- Newly designed Line Voltage Control compensates for variation of any line voltage between 105 Volts and 130 Volts.

Extra Service

The Model TV-11 may be used as an extremely sensitive Condenser Leakage Checker. A relaxation type oscillator incorporated in this model will detect leakage even when the frequency is one per minute.

***NOISE TEST**

Phono Jack on front panel for plugging in either phones or external amplifier will detect microphonic tubes or noise due to faulty elements and loose external connections.

The Model TV-11 operates on 105-130 Volt 60 Cycles A.C. Comes housed in a beautiful hand-rubbed oak cabinet complete with portable cover. Size 11 1/2" x 13" x 6". Shipping Weight 15 lbs.

\$47⁵⁰ NET

MONEY BACK GUARANTEE!!

GENERAL ELECTRONIC DISTRIBUTING CO. DEPT. RC-4, 98 PARK PLACE, NEW YORK 7, N. Y. Phone REctor 2-1677
GENTLEMEN: PLEASE RUSH THE MATERIAL LISTED BELOW:

QUANTITY	MODEL	PRICE	TOTAL

Name _____
 Address _____
 City _____ Zone _____ State _____
 \$ _____ (Payment in Full Enclosed)
 \$ _____ (Deposit Enclosed—Ship Balance C.O.D.)

22 YEARS and 28 Manuals TELL THIS STORY

Most servicemen inform us that they prefer RIDER MANUALS for their absolute reliability. Daily, they depend upon our Factory-Authorized, Factory-Accurate servicing information (from the service departments of the receiver manufacturers themselves) to speed repairs . . . remove all guesswork . . . and assure the satisfactory completion of repair jobs, whatever their nature.

Others favor the completeness of RIDER MANUALS . . . and the fact that, from this SINGLE SOURCE, they can get everything they need . . . original production runs, subsequent production runs—with all the changes.

And still others say it's the ease with which they are able to locate the exact data they want . . . and the ease with which they can make full use of this information.

Whatever their individual reasons may be, they all agree

Rider Manuals ARE BEST

The Latest in Television!

Rider TV Manual Vol. 6



Despite severe production difficulties, this new "BIG" TV Manual is ready for you. However, due to extreme paper shortages, we were unable to produce as many as we feel will be required. So make sure of your copy . . . order it from your jobber TODAY! This is another

LARGE SIZE manual, with the equivalent of 2320 of our former 8 1/2 x 11" page size, all filed in place. **\$24.00**

The Latest in Radio!

Rider Manual Vol. XXI



FACTORY-AUTHORIZED servicing material from 61 manufacturers . . . AM-FM—Auto Radios—Record Changers—Disc and Tape Recorders. Coverage from Dec. 1949 through Oct. 1950. 1648 Pages PLUS Cumulative Index Volumes XVI through XXI. **\$21.00**

Make sure that your Working Library of RIDER MANUALS is complete . . . with ALL of these indispensable volumes on hand.

Television Manual Volume 6 (Plus Index)	\$24.00
Television Manual Volume 5 (Plus Index)	24.00
Television Manual Volume 4 (Plus "How It Works" Book and Index)	24.00
Television Manual Volume 3 (Plus "How It Works" Book and Index)	24.00
Television Manual Volume 2—In new, larger page size, 12" x 15". (Plus "How It Works" Book and Index)	24.00
Television Manual Volume 1 (Plus "How It Works" Book and Index)	19.80
Volume XXI	21.00
Volume XX	21.00
Volume XIX	22.50
Volume XVIII	22.50
Volume XVII	19.80
Volume XVI	9.99
Volume XV	22.50
Volume XIV to VII (each volume)	19.80
Volume VI	15.00
Abridged Manuals I to V (one volume)	19.80
Master Index, Covering Manuals Vol. I to XV	1.50
PA Equipment Manual, Volume I	18.00

JOHN F. RIDER PUBLISHER, INC.
480 Canal St. New York 13, N. Y.

tube. An arrow shows that the magnet may be rotated through 90 degrees to control tube gain. Gain versus rotation of magnet is drawn in *b*. Since the degeneration is greatest at higher frequencies (due to the capacitor), bass boost is greater at low gain. This is usually a desirable characteristic for audio circuits.

COLOR TV TUBE

Patent No. 2,529,485

Thornton W. Chew, United States Navy
(May be used by the United States Govt. without royalty payment)

An improved tri-color tube, this kinescope has parallel, closely-spaced horizontal wires, one for each scanning line on its screen. Each wire is coated with a phosphor strip to produce color under electron bombardment. The phosphor colors are alternately green, red and blue. For example, the top line produces green, the second red and the third blue. The fourth wire produces green again, etc. As the figure shows, each conductor is insulated from the two adjacent and those of the same color are connected together.

The video image is scanned as usual line by line. The phosphors are so thin and close to-

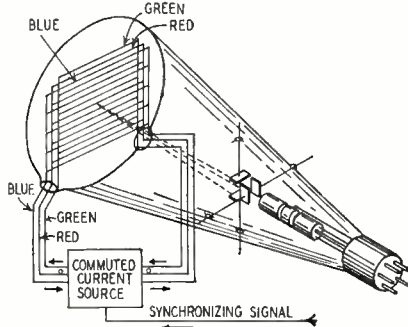

gether that it is important to accurately control the path of the scanning beam. This is done here by a magnetic field generated by currents through the horizontal wires.

At a given instant the 2nd, 5th 8th . . . wires carry no current. The 1st, 4th, 7th . . . carry current in one direction. Current flows in the opposite direction through the 3rd, 6th, 9th . . . wires. The wires which carry current are surrounded by magnetic fields. These urge the scanning beam away from these wires and towards a conductor which carries no current. For example, in the figure the beam is deflected to scan the 8th line. Due to irregularities in the screen structure or deflecting system the beam may not be accurately centered on the 8th line. However, at this particular instant the 8th wire carries no current while the 7th and 9th do. Therefore the beam will be guided to follow the 8th wire during this line period.

During the next line period the beam will tend to scan the next lower line. This time the 9th wire will be current-free while the 8th and 10th carry currents in opposite directions. Therefore the beam will scan accurately again as required. Current switching may be done electronically or mechanically by any desired method.

This type of tube can also reproduce stereoscopic images. For this purpose two colors are needed, each associated with a different stereoscopic camera. The viewer may use a color filter to permit each eye to see only one of the colors. The picture blends to appear in three dimensions.

SENSITIVE CONTROL RELAY

Patent No. 2,515,314

Raymond T. Pierce, Millburn, N. J.
(Assigned to Weston Electrical Instr. Corp.)

Far more sensitive than conventional armature types, this relay is essentially a d'Arsonval microammeter with a pointer that carries an iron rider. When the pointer is deflected, the rider touches a fixed contact and closes a circuit. Many control instruments can use this type of relay. As an example, a temperature control arrangement will be described.

In this case the microammeter coil is fed by a thermocouple which measures temperature. The thermocouple circuit is adjusted for mid-deflection of the pointer at the desired temperature. If the temperature drops for any reason the pointer falls back to the left. When R approaches the magnetic contact A, it is drawn forward with considerable force and a good electrical contact

BEAT THE TUBE SHORTAGE!

Receiving tubes are getting scarcer every day! This book shows you how to keep sets working . . . even though exact replacements are unavailable.

RECEIVING TUBE SUBSTITUTION GUIDE BOOK

BY H. A. MIDDLETON
for TV-AM-FM Receivers and Allied Equipment!

★ 2500 Radio and TV Substitutions are Listed! ★ TV Receiver Filament Wiring! ★ Heater Substitution Wiring Instructions! ★ Tube Types Classified by Functions! ★ Other Priceless Data!

Place your order today! First printing sold within 21 days! Second printing is now on press and will sell as fast! Make sure of your copy!

224 pages. 8 1/2 x 11 inches. Heavy, durable paper cover. Only \$2.40

BE EXPERT with OSCILLOSCOPES

This practical book tells you everything you should know about an oscilloscope! WHAT it is . . . what it can DO . . . and HOW to use it properly!

ENCYCLOPEDIA ON CATHODE-RAY OSCILLOSCOPES AND THEIR USES

by John F. Rider and Seymour D. Uslan

The FIRST and ONLY book that so fully and clearly describes the 'scope . . . its construction . . . its capabilities . . . its applications in servicing, engineering, research . . . with thousands of time-saving and labor-saving references, charts, waveforms, etc.



All oscilloscopes produced during the past ten years, a total of more than 70 different models, are accurately described—with specifications and wiring diagrams.

Planning to buy a 'scope? This book will help you select the type best suited to your needs! If you already own one, the book will

show you how to increase your instrument's usefulness and, naturally, its value to you!

We GUARANTEE that it will SAVE and EARN many, many times its cost for you!
992 Pages • 500,000 Words • 3,000 Illustrations
8 1/2 x 11" Size • 22 Chapters • Completely Indexed
Easy to Read • Cloth Bound And only \$9.00

with ANTENNAS

TV and OTHER RECEIVING ANTENNAS



(Theory and Practice)
by Arnold B. Bailey

Tells you . . . WHAT each type can do . . . and HOW to use it . . . and WHICH is best!

This is a text book on all types of receiving antennas. If you have any questions—you'll find the answers in this book! Teacher, engineer, student, service technician—all can use this text. WE GUARANTEE IT! Antenna data never before published anywhere will be found in it. And it's readable—because mathematics has been translated into charts and graphs.

Everything you hoped for . . . and asked for!
606 Pages . . . 310 Illustrations And only \$6.00

10-DAY MONEY-BACK GUARANTEE—Make these books PROVE their value! Unless you agree they are the best investments you've ever made—return the books, in good condition, for refund.

RUSH THIS COUPON TODAY

JOHN F. RIDER PUBLISHER, INC.
480 Canal Street, New York 13, N. Y.

Please send me the following books on your 10-day MONEY-BACK GUARANTEE.

RECEIVING TUBE SUBSTITUTION GUIDE BOOK \$2.40
"ENCYCLOPEDIA ON CATHODE-RAY OSCILLOSCOPES AND THEIR USES" 9.00
"TV and OTHER RECEIVING ANTENNAS" 6.00

Name
Address
City Zone State
SAVE POSTAGE. If you enclose check or money-order WITH coupon, we will prepay postage charges. Money back if you return books within 10 days.

Check Encl. Money-Order Encl. C.O.D.

PRESCRIPTION FOR THE TV SERVICING EPIDEMIC!

tremendously increased load of Service calls—now turning to OAK RIDGE! Designed and developed by TV Service Engineers, Oak Ridge Portable Laboratory of Four Test Instruments permits servicing with or without station on the air, supplies substitution signal for all TV circuits: Pix, Sound, Synch, Sweep, Linearity, etc. TV troubles now quickly, easily found and corrected right on the job, by the only fool-proof method: Signal Tracing by Signal Substitution!

Four OAK RIDGE Precision Portable TV TEST INSTRUMENTS

... Solve 95% of TV Servicing Problems
RIGHT ON THE JOB!



**MODEL 101
SUBSTITUTION
TESTER**

Has Test Speaker with voice coil and transformer connections, range of resistors, paper, ceramic, electrolytic condensers, variable pot; and simple

sig. tracer—can be used as audio signal tracer for Radio & TV. Dealer's Net... **\$17.95**

**MODEL 103
SIGNAL GENERATOR**

Combines small size, sturdiness, ACCURACY and dependability. Locates trouble fast, from antenna to CRT or speaker. Packed with features to make TV servicing easier, faster, more

profitable! Dealer's Net... **\$33.50**



**MODEL 104
"SYN-
CHRO-
SWEEP"**

Pat.App.For

New invention for TV testing, widely endorsed by experts. Supplies own synch. and sweep pulses for signal tracing synch. and sweep circuits with or without test pattern, scope, or bench equipment! Dealer's Net... **\$44.50**



**MODEL 102
HIGH
VOLTAGE
TESTER**

Contains 4 instruments described here. Each individually removable.

**Model
A-100
Net Price
\$122.40**

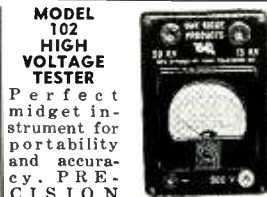

Perfect midget instrument for portability and accuracy. PRECISION MOVEMENT has 3 ranges: 0-500V, 0-150KV, 0-30KV and 10,000 ohm-per-volt sensitivity. Ideal for hi-voltage testing of TV sets right in the home! Dealer's Net... **\$17.95**

*Write today for YOUR FREE COPY of New Oak Ridge Technical Booklet "TV SERVICING TODAY" A GOLDMINE of information. Detailed description of new improved servicing techniques. You can't afford to be without it—and it's yours for the asking!

OAK RIDGE PRODUCTS

Mfg. Div. of Video Television, Inc.
37-01-C Vernon Blvd.,
Long Island City 1, N. Y.



POLIC-ALARM
RADIO APPARATUS CORPORATION
DEPT. RE-4 310 FOUNTAIN SQUARE THEATRE
BLDG., INDIANAPOLIS 3, INDIANA

Get
**EMERGENCY BAND
CALLS At Home!**

• Many fans spend hundreds of happy hours listening to city and state police calls on their Polic-Alarm radios. ... Polic-Alarm Model PR-31 is a quality radio which will give years of trouble-free service on the 30-50 mc. band. Can be used on either AC or DC current of 115 volts.

Besides police calls, the 30-50 mc. band also is used by fire departments, ambulances, border patrol, forestry, maritime, railroads, bus lines, and other services. Enjoy the thrill of listening to these vital messages at home. Model PR-31 (illustrated) **\$44.95**

Polic-Alarm Model PR-8 is available for 152-162 mc. band reception. **\$44.95**
Price, complete

is made. Now current flows through the positive terminal of the d.c. source, through A, the pointer, solenoid S, a limiting resistor and back to the negative terminal. S pulls up on its armature with the following results:

The d.p.s.t. solenoid contacts are permitted to close. One pole closes the heater circuit (not shown) to increase the temperature. The other pole connects S across the d.c. without need to flow through the pointer.

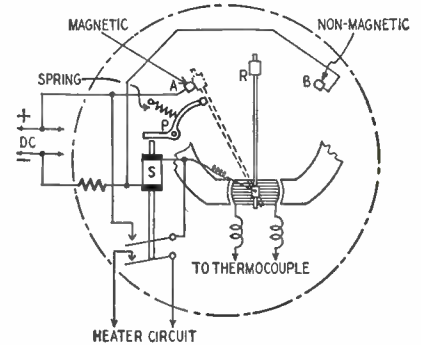

The armature applies pressure against a re-setting arm pivoted at P. This arm kicks the pointer (dotted line position) to free R from the magnetic contact A. This leaves the pointer free to deflect to the right when the thermocouple output is sufficient.

As the temperature rises more current flows into the microammeter coil and the pointer deflects to the right. Finally R contacts B and the pointer shorts out S to release its armature and open the solenoid contacts. The heater circuit is broken and the temperature begins to fall. Also, S is disconnected from the d.c. supply. The entire cycle repeats as above when the temperature reaches its lower limit.

COMPENSATOR FOR CATHODE EMISSION

Patent No. 2,523,468

Donald G. C. Hare, Greenvale, N. Y.
(Assigned to United States of America as represented by the Secy. of Navy)

Emission from a cathode is irregular because the heated particles are not shot off uniformly. These fluctuations are especially important when an input signal is relatively weak (as in a preamplifier). This invention utilizes a 6L7 as an amplifier which is stabilized against such fluctuations.

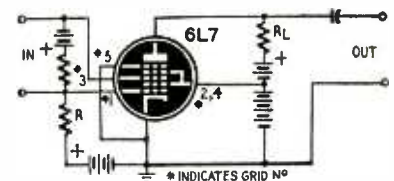

The first grid of the pentagrid tube is the compensating element. It is connected through R and a battery to ground. When cathode current is above normal, more electrons reach this element and the negative drop across R is increased. The negative bias on the control grid 3 therefore becomes greater and the tube amplification is reduced. This tends to balance out the greater cathode emission.

When the emission is below normal, there is a smaller negative voltage drop across R. Due to smaller bias on grid 3 the tube amplification is increased. This opposes the emission loss and tends to maintain a constant plate current.

The compensation is complete when R is properly chosen.

GRID EMISSION DETECTOR

Patent No. 2,523,487

Zigmond W. Wilchinsky, Washington, D. C.
(Assigned to United States of America as represented by the Secy. of Navy)

Grid emission occurs if active material from the cathode of a tube contaminates the grid in some way. The contaminated element, when heated, becomes a virtual cathode and emits electrons. Grid emission may lead to erratic oper-

ation and possible damage to components. This indicator operates continuously and shows both the presence and amount of grid emission that occurs in a tube.

The figure shows a triode Hartley oscillator in a pulsed circuit. Its plate supply is rapidly and regularly switched on and off by a modulator (not shown). In a typical radar, the on period might be several microseconds. The off interval may be several hundred times as long.

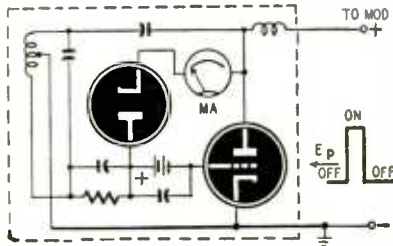

During the on period, the diode is blocked because its cathode is at high positive potential. Therefore the oscillator operates normally. During the off interval the triode plate voltage is near zero and the diode may conduct. If the triode grid emits electrons, it continues to do so during this off period because the grid remains warm during this very short time. Electrons from the grid reach the plate, and current flows through the meter, the diode, battery, and back to the grid of the triode.

By noting the meter periodically, the operator may replace the triode as soon as grid emission reaches a predetermined level and before it affects the operation of the equipment.

STORAGE TUBE

Patent No. 2,527,652

John R. Pierce, Millburn, N. J.

(Assigned to Bell Telephone Labs, Inc.)

An entire field of a video signal may be recorded in this storage or recording type cathode-ray tube for subsequent reproduction. The tube has a conventional electron gun and deflectors, but it also includes a special grid G and a target T. T is a thin layer of diamond dust which has its rear surface coated with metal.

Normally diamond is a good insulator, but when bombarded with electrons, it becomes conductive. The bombardment releases other inner electrons

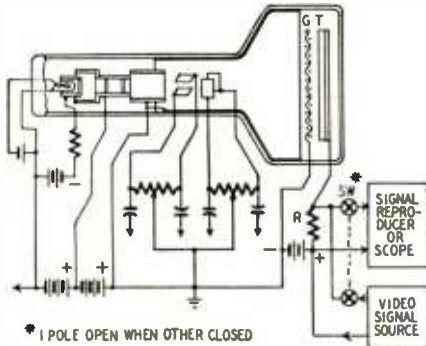

which may be influenced by an electrostatic field. This principle is used in the new tube to store a full video field.

To store a signal, the upper section of ganged switch S is left open. The deflecting plates cause the electron beam to scan layer T line by line as usual. At the same time the video signal is applied to T to control its conductivity. For example, if the beam arrives when the signal is positive the released electrons can move through the diamond layer to reach the metal coating. If the signal is negative, however, the released electrons remain as a charge between opposite surfaces of T. The intensity of charge depends upon the video signal voltage.

To reproduce the image, S is thrown to its other position, and T is scanned again by the beam. As electrons fall upon each element of T in turn, that particular point becomes conducting for an instant. If a charge has been stored at that point electrons move through T to the metal coating to flow through R. This produces a voltage drop across the output device (which may be an oscilloscope). The reproduced image is like the original but is delayed until the screen is scanned the second time.

— END —



Engineering Achievement

Since the Eiffel Tower was first opened 62 years ago this month it has thrilled millions and become a world-famous Parisian landmark, standing as a monument to the engineering skill of its builder.

Similarly the "T. E. I." insignie of Thomas is a hallmark of picture tube engineering and production skill known throughout the television industry. More than one-half million homes today enjoy the finest television reception on Thomas picture tubes.

For, manufacturers, distributors, and servicemen alike know that when they buy Thomas, they buy an engineering achievement! See just how good a tube can be—try Thomas!

THOMAS ELECTRONICS, Inc.

118 Ninth Street
Passaic, New Jersey

HAVE YOU A JOB FOR A TRAINED TECHNICIAN?

We have a number of alert young men who have completed intensive training in Radio and Television Repairing. They learned their trades thoroughly by working on actual equipment under personal, expert supervision. If you need a trained man, we invite you to write for an outline of our course, and for a prospectus of the graduate. No fees, of course. Address:

Placement Manager, Dept. P108-4

COMMERCIAL TRADES INSTITUTE

1400 Greenleaf Chicago 26

BUILD YOUR OWN 5 TUBE SUPERHET RADIO...

2⁹⁵

ONLY

We furnish all but the components.

- A Beautiful Plastic (Buterine) Cabinet
- A Copper Plated Chassis—Stamped for Mounting Parts
- A Name Plate
- A Calibrated Tuning Dial
- A Volume Control Knob
- A Stamped Jute Back
- 3 Rubber Grommets
- 4 Sheet Metal Screws—For Chassis & Back Mounting
- 5 Miniature Tube Sockets.

All yours to get you started on your own radio. \$1.00 Deposit with C.O.D. orders. You pay postage. Send only \$2.95 and we will pay postage.

THE LORMEL PRODUCTS CO.

10408 Superior Ave. Dept. RE Cleveland 6, Ohio

INDISPENSABLE!

PHOTOFACT BOOKS



Photofact Television Course. Covers TV principles, operation and practice. 216 pages; profusely illustrated; 8½ x 11". Order TV-1 Only \$3.00

Television Antennas. New 2nd edition. Describes all TV antenna types; tells how to select, install, solve troubles. Saves time; helps you earn more. 200 pages; illustrated. Order TAG-1 Only \$2.00

Television Tube Location Guide. Accurate diagrams show position and function of all tubes in hundreds of TV sets; helps you diagnose trouble without removing chassis. 200 pages; pocket-size. Order TGL-1 Only \$1.50

1949-1950 Record Changer Manual. Vol. 3. Covers 44 models made in 1949, including multi-speed changers and wire and tape recorders. Original data based on actual analysis of equipment. 286 pages; 8½ x 11"; paper-bound. Order CM-3 Only \$3.00

1948-1949 Changer Manual. Vol. 2. Covers 45 models made in 1948-49. Paper bound. Order CM-2. Only \$4.95

1947-1948 Changer Manual. Vol. 1. Covers 40 post-war models up to 1948. Order CM-1 Only \$4.95

Recording & Reproduction of Sound. A complete authoritative treatment of all phases of recording and amplification. 6 x 9". Order RR-1 Only \$5.00



Post-War Audio Amplifiers. Vol. 2. A complete analysis of 104 well-known audio amplifiers and 12 well-known tuners made in 1949-50. 368 pages, 8½ x 11". Order AA-2 Only \$3.95

Post-War Audio Amplifiers. Vol. 1. Covers 102 amplifiers and FM tuners made through 1948. 352 pages. Order AA-1 Only \$3.95

Auto Radio Manual. Complete service data on more than 100 post-war auto radio models. Covers over 24 mfgs. 350 pages, 8½ x 11". Order AR-1 Only \$4.95

Communications Receiver Manual. Complete analysis of 50 popular communications models. 246 pages, 8½ x 11". Order CR-1 Only \$3.00

Radio Receiver Tube Placement Guide. Accurate diagrams show where to replace each tube in 5500 radio models, covering 1938-1947 receivers. 192 pages, pocket-size. Order TP-1 Only \$1.25

Dial Cord Stringing Guide. Vol. 2. Covers receivers made from 1947 through 1949. Shows you the one right way to string a dial cord in thousands of models. Pocket-size. Order DC-2 Only \$1.00

Dial Cord Guide. Vol. 1. Covers sets produced 1938 through 1946. Order DC-1 Only \$1.00

Radio-TV Industry Red Book. 2nd Edition. Complete data on replacement parts for 22,000 sets made 1938-1950, including valuable TV information. Covers all major replacements. Over 600 pages. Only \$3.95



Making Money in TV Servicing. Tested, proved methods of operating a profitable TV service business. Written by Eugene Ecklund, B. E. E., former manager of the National Service Department, Allen B. DuMont Laboratories, Inc. Covers planning, financing, work control, purchasing, service charges, advertising—plus much more. Over this practical guide to success now. Over 130 pages. Order MM-1 Only \$1.25

Order from your Parts Jobber or write direct to
HOWARD W. SAMS & CO., INC., 2201 E. 46th St., Indianapolis 5, Indiana

HOWARD W. SAMS & CO., INC.

VOLUME CONTROL FOR THEREMIN

I am building the Theremin shown on the enclosed circuit. (See Fig. 1—Editor.) Note that no provisions have

volume-control rod, the oscillator is loaded, thus reducing its output and the bias voltage on the 6AT6.

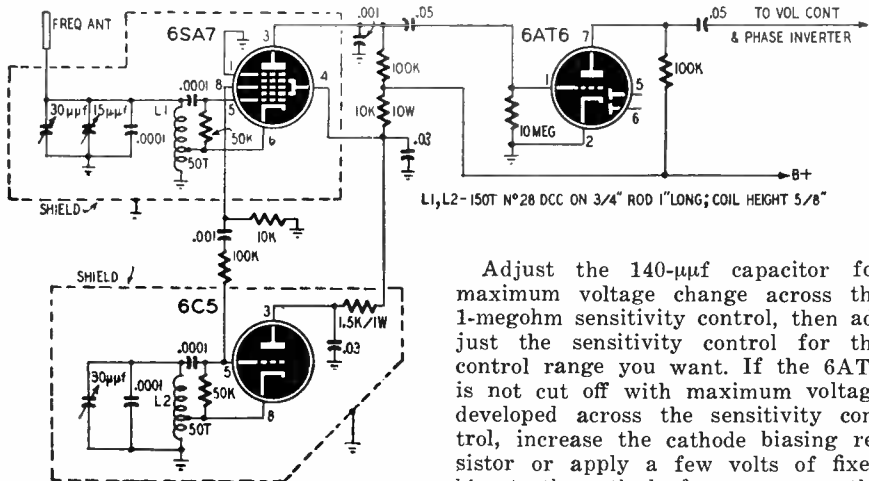

Fig. 1—The schematic of the Theremin.

been made for controlling its output by moving one's hand closer to a volume-control plate or rod. Will you show how the volume can be controlled manually? —J. W. S., Philadelphia, Penna.

A. Fig. 2 shows how a capacitance-operated volume control can be added to your Theremin.

The triode section of the 6S8-GT—or 6T8 if you like miniature tubes—is an oscillator similar to those in the tone circuits. The diode section of the tube is a rectifier which develops a negative bias which is applied to the control grid of the 6AT6 audio amplifier. Under normal conditions, the 6S8-GT is oscillating heavily. The developed bias is adjusted so the 6AT6 does not amplify the signal applied to it. When you bring your hand close to the

Adjust the 140-µf capacitor for maximum voltage change across the 1-megohm sensitivity control, then adjust the sensitivity control for the control range you want. If the 6AT6 is not cut off with maximum voltage developed across the sensitivity control, increase the cathode biasing resistor or apply a few volts of fixed bias to the cathode from a tap on the high-voltage supply.

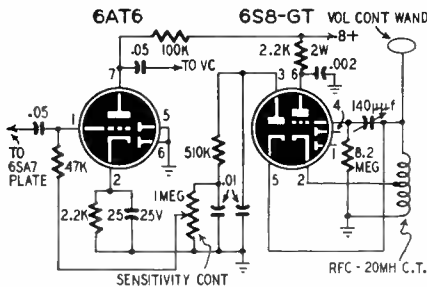

Fig. 2—Hand-operated volume control.

The volume-control oscillator uses a 20-mh, center-tapped r.f. choke. If this circuit resonates close to the other oscillators, shunt it with a small capacitor to shift it away until it won't produce an audible beat.

BASS AND TREBLE CONTROL FOR TV RECEIVER

I have an Admiral (Continental Radio & Television Co.) model 8A receiver. Please show how I can add bass and treble controls without adding more than one tube. The present tone control—a small capacitor cut in between ground and a tap on the volume control—does not work when the phono is in operation. I want the new control to work on radio and phono.—L. R. S., Jr., Braintree, Mass.

A. The basic circuit of the first a.f.

amplifier and phase inverter are shown at a, and a one-tube equalizer which boosts or attenuates bass or treble to 20 db is shown at b. If the controls have logarithmic tapers, equalizer response is flat when they are centered in their arcs.

To connect the equalizer, break the lead to the arm of the volume control between A and B. Connect the input of the equalizer to A and the output to B. Disconnect the phono input lead from the grid of the 75 and connect it to C, the hot side of the volume control. This puts the phono input on the input side of the tone control.

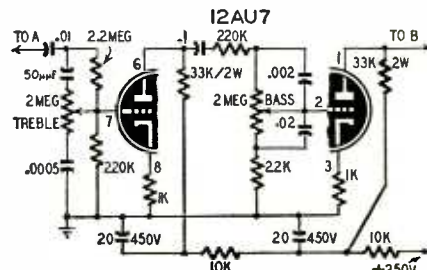
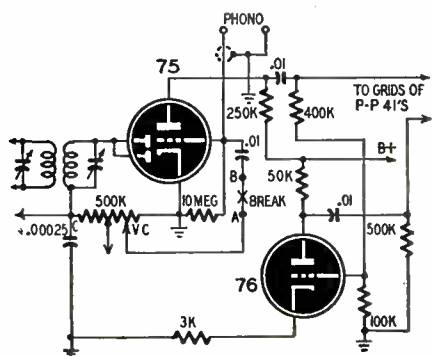

DESIGN DATA FOR 5-ELEMENT YAGI

? Please show plans for constructing a Yagi-type five-element beam antenna for TV channel 3. I would like to have design data for constructing similar antennas for other channels. Does an antenna of this type increase the gain or does it decrease pickup from the rear?—A. W., N.S. Pittsburgh, Penna.

A. The diagram shows the antenna arrangement. Dimensions for the elements are:

- A—Third director.....86.8 inches
- B—Second director.....87.6 inches
- C—First director.....88.4 inches
- D—E—Radiator92.4 inches
- G—Reflector98.0 inches

If a simple dipole is used, the antenna array will have an impedance of approximately 9 ohms. By using a

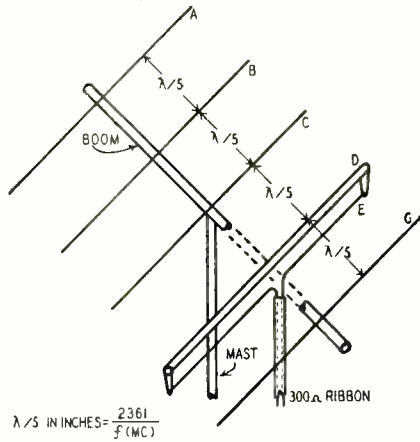

folded-dipole radiator having different size conductors, the antenna impedance is stepped up to nearly 300 ohms to match a 300-ohm transmission line. The larger conductor is 1-inch tubing and the smaller is No. 12 wire. These conductors are spaced 1 inch apart with ceramic or polystyrene spacers. The wire is broken approximately 2 inches in the center so the transmission line can be connected.

The lengths of the third, second, and first directors, radiator, and reflector in inches are found by dividing 5208, 5256, 5304, 5344, and 5880, respectively, by the frequency in megacycles. Because antennas of this type perform better if they are off resonance on the high side rather than on the low, we advise cutting the antenna for the low-frequency end of a given channel for best results.

Elements other than the radiator can be made from tubing 1/2 inch in diameter or smaller, depending on the length.

Antennas of this type cannot be simultaneously adjusted for maximum forward gain and maximum front-to-back ratio. The lengths of the parasitic elements and the spacing between them is so critical that 0.2 wavelength spacing is used between all elements to effect a compromise which will produce a gain of approximately 10 db while maintaining a good front-to-back ratio for most installations.

TWIN LEAD, TELEVISION LIGHTNING ARRESTER

APPROVED for OUTDOOR-INDOOR Use \$2²⁵
Protects Television Sets
Against Lightning and Static
Charges

JFD SAFE TV GUARD

Simple to install everywhere and anywhere
...no stripping, cutting or spreading of
wires. More than 300,000 in use today!

SEE YOUR JOBBER OR WRITE TO

JFD MANUFACTURING CO., Inc.
6101 D 16th Avenue, Brooklyn 4, N. Y.
First in Television Antennas & Accessories

FREE! BOOK OF TV PICTURE PATTERNS & WAVE FORMS

Quick Reference TV Servicing Book Yours Free Just For Examining Coyne's New 5-Volume Set APPLIED PRACTICAL RADIO-TELEVISION

ON 7 DAYS' FREE TRIAL!

OFFER LIMITED—SEND COUPON TODAY!
Mail coupon for 7 days' FREE TRIAL on COYNE'S 5-volume set. I'll include the book of TELEVISION PICTURE PATTERNS. If you keep the set you pay \$3.00 after 7 days trial and \$3.00 a month until \$16.50 plus postage is paid (Cash price \$15.00). If no 100% satisfied with the set send it back and you OWE NOTHING. EITHER WAY, HOWEVER, THE BOOK OF TELEVISION PICTURE PATTERNS IS YOURS FREE TO KEEP. Coupon is just a request to see the set and get the FREE book of picture patterns. This sensational offer is limited—SEND THE COUPON NOW.

SEND NO MONEY • MAIL COUPON NOW!

COYNE ELECTRICAL & TELEVISION-RADIO SCHOOL, Dept. 41-T1
500 S. Paulina St., Chicago 12, Ill.

O.K.! Rush "APPLIED PRACTICAL RADIO-TELEVISION" for 7 days' FREE TRIAL as per offer above. INCLUDE COPY OF TELEVISION PICTURE PATTERN BOOK AS MY FREE GIFT FOR EXAMINING THE SET.

NAME.....AGE.....
ADDRESS.....
CITY.....ZONE.....STATE.....
WHERE EMPLOYED.....
 Check here if you want set sent COD. You pay postman \$15.00 on delivery. Same money-back guarantee of satisfaction.

COYNE ELECTRICAL AND TELEVISION-RADIO SCHOOL
An Institution Organized Not for Profit
500 SO. PAULINA ST. • DEPT. 41-T1 • CHICAGO 12, ILL.

QUAM

Adjust-A-Cone

SPEAKERS

FIRST in Replacement Field FIRST for Original Equipment



with the ADJUSTABLE VOICE COIL

NO RUBBING VOICE COILS

There is nothing more annoying than a squawking speaker with a rubbing voice coil! It can easily happen to any conventionally built speaker where the spider is cemented in place with no means of adjustment.

But not on a Quam Adjust-A-Cone Speaker. Just before it is packed for shipment, as the last production operation, the Quam Adjustable Voice Coil is carefully and exactly centered. Rubbing Voice Coils are unheard of on Quam Speakers, and dissatisfied customers will be equally rare when you "REPLACE WITH QUAM"

WRITE FOR COMPLETE QUAM CATALOG

Also Makers of Quam Focallter Units and Ion Traps

QUAM-NICHOLS COMPANY

521 E. 33rd Place Chicago 16, Illinois

MAKERS OF QUALITY SPEAKERS FOR 27 YEARS UNDER THE SAME MANAGEMENT

BUY DIRECT SAVE!!
From Factory

New Improved 32 tube—630TS type chassis \$175⁹⁵
Fed. Tax Incl. (Less CRT)

Complete with:
• New Electro-Scope Magic Eye Tuning Indicator
• Completely wired and aligned by expert technicians.
• Newly developed keyed automatic gain control.
• Latest type Standard Coil tuner.

NEW SENSATIONAL MODEL 622 \$144⁹⁵
Tax Incl. (Less CRT)

22 Tube Chassis with co-channel sound (not inter-carrier) AVAILABLE
ALL SIZES—BRAND NAME PICTURE TUBES

Both Chassis for 16", 17", 19" or 20" Tubes
Regular RMA guarantee on all tubes and chassis
Beautiful cabinets for above—available
Terms: \$25.00 deposit on all orders—Balance C.O.D.
F.O.B.—N. Y. Factory
Prices subject to change without notice
IMMEDIATE DELIVERY Visit our showrooms

AD-RITZ MFG. CORP. 158 Grand Street New York, N. Y. Phone WO 4-6763

HIGH-GAIN CONVERTER HAS CRYSTAL CONTROL

? I need a crystal-controlled converter for use in the 37-to-40 mc band. I have tried a number of circuits without much luck. The signal-to-noise ratio has been too low in some and the sensitivity too low in others. Can you design a circuit which might work? The converter should work into a 5-mc i.f. strip or a receiver.—R. E. D., Fort Worth, Texas

A. The two high-gain, low-noise r.f. amplifiers should boost the signal to a point where it swamps the shot noise in the mixer. The popular "R-9'er"

wire 3/4 inch in diameter and 5/8 inch long. L6 has 5 turns of No. 18 wire 3/16 inch in diameter and 5/16 inch long. These may be cut from B & W type 3011 Miniductors.

After selecting the correct crystal, use a wavemeter to peak L5 to the second and L6 to the sixth harmonic of the crystal. Use a good grade of 52-ohm coax to connect the antenna to the input and receiver or i.f. strip to the output. Keep the coaxial as short as practical. Set slugs in L1, L2, L3, and L4 by peaking a signal on the desired fre-

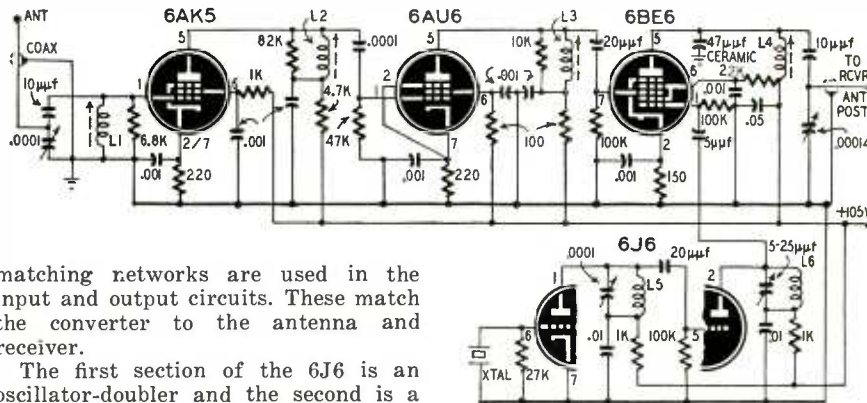

quency. Adjust the input and output variable capacitors to further peak the signal. If either circuit peaks at maximum or minimum capacitance, add a few inches of coax so the circuits peak with the capacitors at mid-range.

Use shields between the individual circuits of L1, L2, L3, and L4. Construct the oscillator-multiplier circuits in a separate compartment.

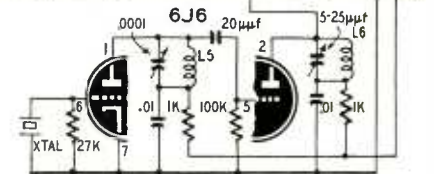

OSCILLATOR CIRCUIT FOR 60-WATT TRANSMITTER

? I constructed the 60-watt transmitter described on page 42 of the March, 1950, issue and have had many nice QSO's with it. It will be nearly a year before I can qualify for a class A license so I would like to modify the transmitter for 10-meter phone. Can you give me any dope on multiplying down to 10? Can this rig be operated with 750 volts on the final plate?—J. P., Dade City, Fla.

the tube to be run at 75 watts input from a 750-volt supply. Maximum phone ratings are 600 volts at 100 ma. For phone operation under these conditions, change the screen-dropping resistor to 50,000 ohms, 10 watts. Adjust the drive to the 807 so its grid current is approximately 6.5 ma.

Any audio amplifier delivering 30 watts or more will do as a modulator. Replace the output transformer with a 30-50 watt modulation transformer having a 6,000-ohm secondary and a primary which will match the modulator tubes. Connect the secondary to the 807 plate coil through an r.f. choke.

A. If you built the rig exactly as shown in the photograph, you will probably have a hard time finding sufficient space for a multiplier stage. We suggest that you rewire the oscillator to conform to the circuit shown in the diagram. This circuit is easy on crystals and operates on the fundamental as well as the second, third, and fourth harmonics.

For 10-meter phone you can use crystals between 7.128 and 7.421 or between 9.503 and 9.896 mc. The 10-meter coil in the oscillator may consist of 10 turns of No. 14 enameled wire close-wound on a 3/4-inch form. This midget coil and its tuning capacitor may be mounted in a small plug-in shield mounted close to the plate of the 6AG7.

ICAS c.w. ratings for the 807 permit

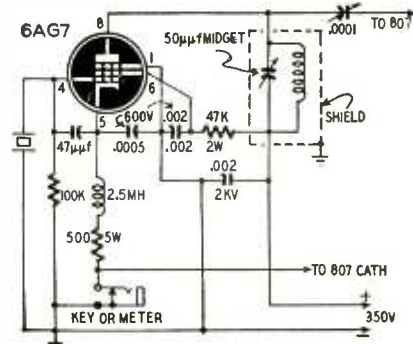

TUBE SUBSTITUTIONS

? I have an a.c.-d.c. set which has a 35W4, 50B5, 12BA6, 12BE6, and 12AT6 connected across the line in that order. I cannot find a replacement for the 12BA6, so I want to install a 6BA6. What changes are necessary in the circuit of the heater string?—F. H. R., Vicksburg, Miss.

A. The diagram shows the usual heater arrangement at a and the modifications at b. R1 provides a drop of 6 volts

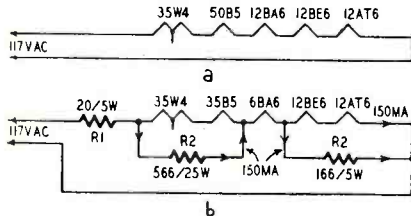

when the 12BA6 is replaced by its 6-volt equivalent. The 6BA6 draws 300 ma which would pass through all the tubes in the string if it were not for the shunt resistors R2 and R3. Shunt resistors are required around the heaters of all tubes which draw less current than others in the string.

To find the value of a shunt resistor, divide the voltage across the tube or tubes on one side of the high-current tube by the difference in heater currents in amps. The difference in current drawn by the high- and low-current tubes is passed by the shunt resistor.

The total voltage across the 35W4 and 50B5 is 85 and that across the 12BE6 and 12AT6 is 25.2. Therefore R2 equals $85/0.15$ or 566 ohms and R3 equals $25.2/0.15$ or 166 ohms.

The power dissipated in R1, R2, and R3 is 1.9, 12.7, and 3.7 watts respectively. For factors of safety, use the next larger commercial wattage rating that may be available.

SAWTOOTH GENERATOR

? I constructed the 5-inch scope described on page 58 of your November, 1947, issue. What are the maximum and minimum frequencies corresponding to the settings of the coarse frequency control?—E. A., Iberville, P. Q.

A. The circuit is printed here. The exact ranges depend on the plate and cath-

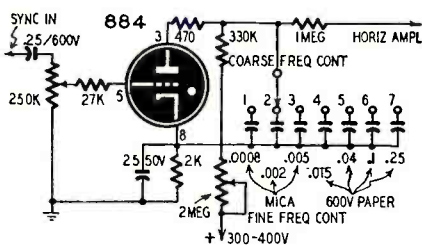

ode voltages and the condition of the capacitors and aging in the 884 tube. The approximate ranges covered by the fine frequency control when the course control is in positions 1 through 7 are: 3,500-11,500, 1,500-5,000, 700-2,200, 300-900, 100-350, 40-150, and 20-60 cycles respectively. The maximum frequency corresponds to the minimum resistance setting of the fine frequency control.

—END—

FIRST BECAUSE THEY LAST

TEL-A-RAY — the antenna of unquestioned quality — eliminates "antenna shopping." Skillfully engineered to meet every TV need, the TEL-A-RAY antenna system insures outstanding fringe area performance the first time. The Reception Master antenna coupled with the new antenna mounted Pre-Amplifier brings strong, clear pictures to the weakest areas. One call . . . one installation is all that's needed. Replacement is eliminated. Reception Master antennae are built of the finest dural to resist corrosive weather damage. The element ends are sealed by the exclusive TEL-A-Roll process.

TEL-A-RAY is right the first time!

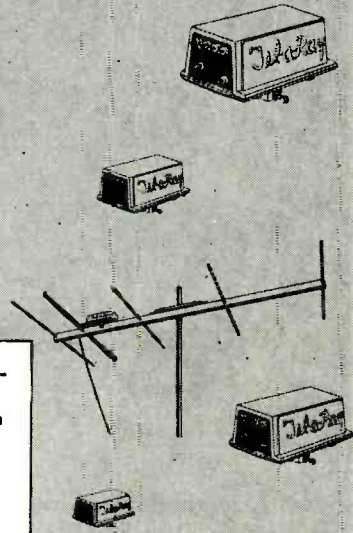

Tel-a-Ray

ENTERPRISES INCORPORATED
BOX 332E - HENDERSON - KENTUCKY

Let MILTON S. KIVER Help You Prepare For **COLOR TV** And...

TELEVISION SERVICING

Easy to TRAIN AT HOME This Practical Way!

Men with the right training in Television Servicing are in big demand . . . pull down big pay. T.C.I. TRAINS YOU RIGHT with easy-to-follow technical training designed by servicemen, for servicemen! You learn practical, professional type Television Servicing without leaving your present job. Included are money-making extras such as set conversion, master antenna installation, COLOR TV and field servicing short cuts. You can start earning Television money after the first few lessons. You learn to test, trouble shoot and repair all types of TV sets. You learn **COLOR CONVERSION** too!

HERE'S HOW YOU GET EXPERIENCE!

You train on your own large screen modern television receiver, furnished as part of your course. This set is yours to keep! As an optional feature you can get two weeks of actual field experience out on service jobs and on the repair bench for Chicago's largest independent servicing organization. You learn Television Servicing by actually doing Television Servicing . . . you get the practical know-how you need to qualify for BIG MONEY in this fast-growing field! Age is no barrier. Many TCI students are over 40!

ACT NOW! Fill out and mail coupon for FREE Catalog and SAMPLE LESSON. Write TODAY!

TELEVISION COMMUNICATIONS INSTITUTE

205 W. Wacker Dr., Dept. RE-2 Chicago 6, Ill.

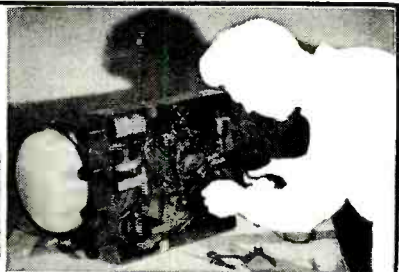

YOU GET and keep famous RCA 630 TS type Television receiver.

YOU DO actual testing, servicing, trouble shooting and repairing.

FOR THE BEGINNER
TCI offers a low-cost Pre-Television Course in Radio, especially designed to prepare you for television in just 5 to 7 weeks. Everything you need from basic radio through servicing . . . to Television.

MAIL NOW FOR FREE BOOKLET

MILTON S. KIVER, President
TELEVISION COMMUNICATIONS INSTITUTE
205 W. Wacker Dr., Dept. RE-2, Chicago 6, Ill.

O. K. Mr. Kiver! Rush FREE Catalog on your practical home study course in Television Servicing, including COLOR TV. Include FREE Sample Lesson. I am not obligated. Salesman will not call.

Name Age
Address
City Zone State
() BEGINNERS check here for information on Pre-Tel Radio Course.

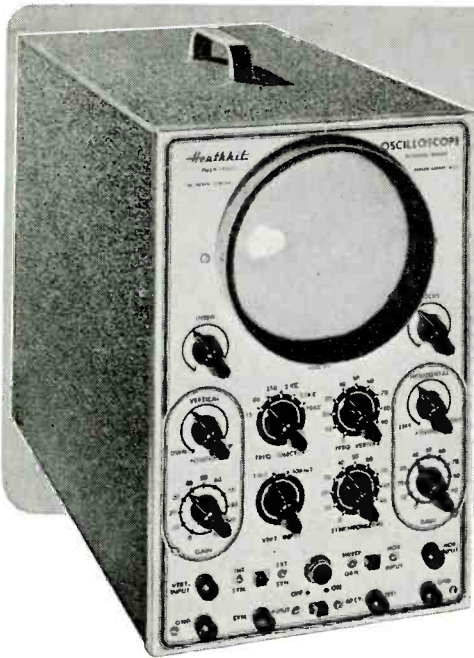

Heathkit MODEL 0-6... PUSH-PULL... 5" OSCILLOSCOPE KIT

The new Heathkit 5" Push-Pull Oscilloscope Kit is again the best buy. No other kit offers half the features—check them.

Measure either AC or DC on this new scope—the first oscilloscope under \$100.00 with a DC amplifier.

The vertical amplifier has frequency compensated step attenuator input into a cathode follower stage. The gain control is of the non frequency discriminating type—accurate response at any setting. A push-pull pentode stage feeds the CR tube. New type positioning control has wide range for observing any portion of the trace.

The horizontal amplifiers are direct coupled to the CR tube and may be used as either AC or DC amplifiers. Separate binding posts are provided for AC or DC.

The multivibrator type sweep generator has new frequency compensation for the wide range it covers; 15 cycles to over 100,000 cycles.

The new model 0-6 scope uses 10 tubes in all, including 5" CR tube. Has improved amplifiers for better response useful to 2 megacycles. Tremendous sensitivity .04V RMS per inch horizontal—.09V RMS per inch vertical. Only Heathkit Scopes have all the features.

New husky heavy duty power transformer has 50% more laminations. It runs cool and has the lowest possible magnetic field. A complete electrostatic shield covers primary and other necessary windings and has lead brought out for proper grounding.

The new filter condenser has separate sections for the vertical and horizontal screen grids and prevents interaction between them. An improved intensity circuit provides almost double previous brilliance and better intensity modulation.

A new synchronization circuit allows the trace to be synchronized with either the positive or negative pulse, an important feature in observing the complex pulses encountered in television servicing.

The magnetic alloy shield supplied for the CR tube is of new design and uses a special metal developed by Allegheny Ludlum for such applications.

The kit is complete, all tubes, cabinet, transformer, controls, grid screen, tube shield, etc. The instruction manual has complete step-by-step assembly and pictorials of every section. Compare it with all others and you will buy a Heathkit.

Model 0-6..... Shipping Wt. 24 lbs.

\$3950

NEW INEXPENSIVE Heathkit ELECTRONIC SWITCH KIT

The companion piece to a scope—Feed two different signals into the switch, connect its output to a scope, and you can observe both signals—each as an individual trace. Gain of each input is easily set (gain A and gain B controls), the switching frequency is simple to adjust (coarse and fine frequency controls) and the traces can be superimposed for comparison or separated for individual study (position control).

Use the switch to see distortion, phase shift, clipping due to improper bias, both the input and output traces of an amplifier,—as a square wave generator over limited range.

The kit is complete; all tubes, switches, cabinet, power transformer and all other parts, plus a clear detailed construction manual.



Model 5-2
Shipping Wt. 11 lbs.

\$1950

New MODEL V-4 A

Heathkit VTVM KIT

The new Heathkit Model V-4A VTVM Kit measures up to 30,000 Volts DC and 250 megacycles when used with accessory probes—think of it, all in one electronic instrument more useful than ever before. The AC Voltmeter is so flat and extended in its response (± 1 db from 20 cycles to 2 megacycles) that it eliminates the need for separate expensive AC VTVM's.

The new 200 microampere, $4\frac{1}{2}$ " streamline meter with quality Simpson movement (five times as sensitive as the commonly used 1 MA meter) has a shatter proof plastic meter face for maximum protection. Meter has all the desirable scales and indicates AC volts, DC volts, ohms, db (direct reading), and even has a special zero center marking for quick FM alignment.

There are six complete ranges for each function. Four functions give total of 24 ranges. The 3 volt range allows 33 $\frac{1}{3}$ % of the scale for reading 1 volt, as against only 20% of the scale on the 5 volt types.

New $\frac{1}{2}$ % ceramic precision resistors are the most accurate commercial type available—you find the same make and quality in the finest laboratory equipment selling for thousands of dollars. The entire voltage divider decade uses these $\frac{1}{2}$ % resistors.

Both AC and DC voltmeter measurements use a push-pull electronic voltmeter circuit, and the meter circuit makes the meter burn-out proof. Electronic ohmmeter circuit measures resistance over the amazing range of 1/10 ohm to one billion ohms, all with internal 3 volt battery. Ohmmeter batteries mount on the chassis in snap-in mounting for easy replacement.

Voltage ranges are full scale—3 Volts, 10 Volts, 30 Volts, 100 Volts, 300 Volts, 1000 Volts. Complete decading coverage without gaps.

The DC probe is isolated for dynamic measurements. Negligible circuit loading. Gets the accurate reading without disturbing the operation of the equipment under test. Kit comes complete: cabinet, transformer, Simpson meter, test leads, complete assembly and instruction manual.

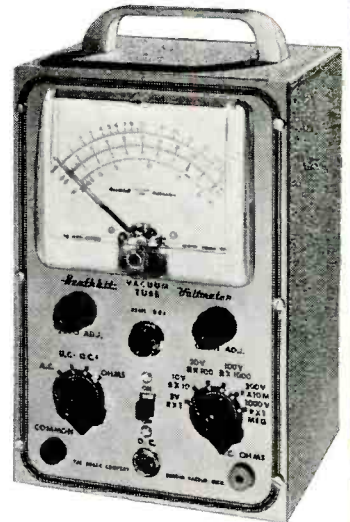

Model V-4A Shipping Wt. 8 lbs.

Note New Low Price

\$2350



Heathkit 30,000V DC PROBE KIT

A new 30,000 V DC Probe Kit to handle high voltages with safety. For TV service work and all other high voltage applications. Sleek looking—Two color molded plastic—Red body and guard—jet black handle. Comes with connector, cable, and PL55 type plug. Plugs into Heathkit VTVM so that 300V scale is conveniently multiplied by 100. Can be used with any standard 11 megohm VTVM.

\$550

No. 336 High Voltage Probe Kit..... Shipping Wt. 2 lbs.

Heathkit RF PROBE KIT

This RF Probe Kit comes complete with probe housing, crystal diode detector, connector, lead and plug and all other parts plus clear assembly instructions. Extends range of Heathkit VTVM to 250 Mc. $\pm 10\%$. Works on any 11 megohm input VTVM. Specify No. 309 RF Probe Kit.



Shipping Wt. 1 lb.

\$550

EXPORT AGENT
ROCKE INTERNATIONAL CORP.
13 40th ST.
NEW YORK CITY (16)
CABLE: ARLAB, N.Y.

The HEATH COMPANY

... BENTON HARBOR 20, MICHIGAN

NEW Heathkit TV ALIGNMENT GENERATOR KIT

Here is an excellent TV Alignment Generator designed to do TV service work quickly, easily, and properly. The model TS-2 when used in conjunction with an oscilloscope provides a means of correctly aligning television receivers.

The instrument provides a frequency modulated signal covering, in two bands, the range of 10 to 90 Mc. and 150 to 230 Mc. — thus, ALL ALLOCATED TV CHANNELS AS WELL AS IF FREQUENCIES ARE COVERED.

An absorption type frequency marker covers from 20 to 75 Mc. in two ranges — therefore, you have a simple, convenient means of frequency checking of IF's, independent of oscillator calibration.

Sweep width is controlled from the front panel and covers a sweep deviation of 0-12 Mc. — all the sweep you could possibly need or want.

And still other excellent features are: Horizontal sweep voltage available at the front panel (and controlled with a phasing control) — both step and continuously variable attenuation for setting the output signal to the desired level — a convenient instrument stand-by position — vernier drive of both oscillator and marker tuning condensers — and blanking for establishing a single trace with base reference level. Make your work easier, save time, and repair with confidence — order your Heathkit TV Alignment Generator now!

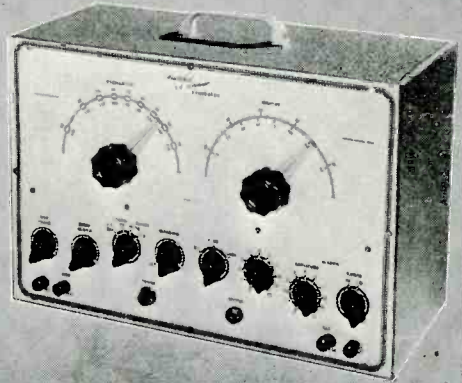

\$3950

Model TS-2
Shipping Wt. 20 lbs.

Heathkit SIGNAL GENERATOR KIT

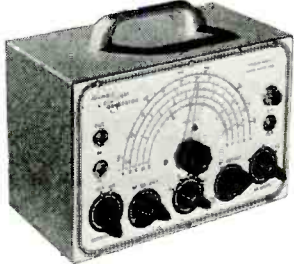

Model SG-6
Shipping Wt. 7 lbs.

\$1950

The new Heathkit Signal Generator Kit has dozens of improvements. Covers the extended range of 160 Kc to 50 megacycles on fundamentals and up to 150 megacycles on useful calibrated harmonics; makes this Heathkit ideal as a marker oscillator for TV. Output level can be conveniently set by means of both step attenuator and continuously variable output controls. Instrument has new miniature HF tubes to easily handle the high frequencies covered.

Uses 6C4 master oscillator and 6C4 sine wave audio oscillator. The kit is transformer operated and a husky selenium rectifier is used in the power supply. All coils are precision wound and checked for calibration making only one adjustment necessary for all hands.

New sine wave audio oscillator provides internal modulation and is also available for external audio testing. Switch provided allows the oscillator to be modulated by an external audio oscillator for fidelity testing of receivers. Comes complete, all tubes, cabinet, test leads, every part. The instruction manual has step-by-step instructions and pictorials. It's easy and fun to build a Heathkit Model SG-6 Signal Generator.

Heathkit SIGNAL TRACER

and UNIVERSAL TEST SPEAKER KIT



Model T-2
Shipping Wt. 7 lbs.

\$1950

The popular Heathkit Signal Tracer has now been combined with a universal test speaker at no increase in price. The same high quality tracer follows signal from antenna to speaker — locates intermittents — finds defective parts quicker — saves valuable service time — gives greater income per service hour. Works equally well on broadcast, FM, or TV receivers. The test speaker has an assortment of switching ranges to match either push-pull or single output impedances. Also tests microphones, pickups and PA systems. Comes complete: cabinet, 110V 60 cycle power transformer, tubes, test probe, all necessary parts, and detailed instructions for assembly and use.

Heathkit TUBE CHECKER KIT

Test your tubes the modern way — dynamically — the simplest, yet fastest and surest method — your Heathkit has a switch for each tube element and measures that element — no chance for open or shorted elements slipping by, all the advantages of the mutual conductance type without the slow cumbersome time consuming setups. Checks for opens, shorts, each element individually, filament and filament tap continuity, and emission.

This Tube Checker has all the features — beautiful 3 color BAD-?-GOOD meter — complete selection of voltages — roller chart listing hundreds of tubes including the new 9 pin miniatures — finest quality Centralab lever switches — high grade birch, counter-type cabinet — continuously variable line adjust control — every feature you need to sell tubes properly. The most modern type tube checker with complete protection against obsolescence. Uses only the best of parts — rugged oversize 110V 60 cycle power transformer, finest Mallory and Centralab switches and controls, complete set of sockets for all type tubes with blank spare for future types. Fast action, gear driven roller chart quickly locates the setting for any type tube. Simplified switching cuts necessary testing time to a minimum and saves valuable service time. Simple method allows instant setup of new tube types without waiting for factory data. No matter what the arrangement of tube elements is, the Heathkit flexible switching method easily handles it. Order your Heathkit Tube Checker Kit today and see for yourself that Heath again saves you two-thirds and yet retains all the quality. Complete with instructions, all parts, and cabinet.

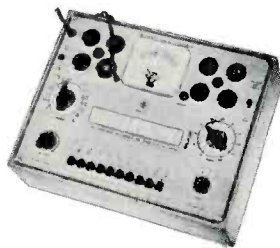

Model TC-1
Shipping Wt. 12 lbs.

\$2950

Heathkit CONDENSER CHECKER KIT



\$1950

Checks all types of condensers — paper, mica, ceramic, electrolytic. All condenser scales are direct reading and require no charts or multipliers. Covers range of .00001 MFD to 1000 MFD. A Condenser Checker that anyone can read. A leakage test and polarizing voltage for 20 to 500 V provided. Measures power factor of electrolytics between 0% and 50% and reads resistance from 100 ohms to 5 megohms. The magic eye indicator makes testing easy.

The kit is 110V 60 cycle transformer operated and comes complete with rectifier tube, magic eye tube, cabinet, calibrated panel and all other parts. Has clear detailed instructions for assembly and use.

Model C-2 Shipping Wt. 6 lbs.

NEW Heathkit HANDITESTER KIT



A precision portable volt-ohm-milliammeter. Uses only high quality parts — All precision 1/2% resistors, three deck switch for trouble-free mounting of parts, specially designed battery mounting bracket, smooth acting ohm adjust control, beautiful molded bakelite case, 400 microamp meter movement, etc.

DC and AC voltage ranges 10-30-300-1000-5000V. Ohms range 0-3000 and 0-300,000 Range Milliamperes 0-10 Ma. 0-100 Ma. Easily assembled from complete instructions and pictorial diagrams.

\$1350

Model M-1 Shipping Wt. 3 lbs.

REPORT AGENT
ROCKE INTERNATIONAL CORP.
13 E. 40th ST.
NEW YORK CITY (16)
CABLE: AREAP-N.Y.

The HEATH COMPANY

... BENTON HARBOR 20, MICHIGAN

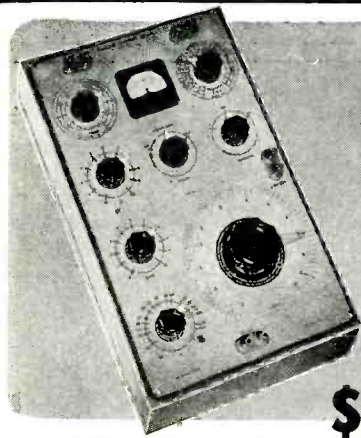

NEW *Heathkit*
IMPEDANCE BRIDGE KIT

This Impedance Bridge Kit is really a favorite with schools, industrial laboratories, and serious experimenters. An invaluable instrument for those doing electrical measurements work. Reads resistance from .01 Ohms to 10 megohms, capacitance from .00001 MFD to 100 MFD, inductance from 10 microhenries to 100 henries, dissipation factor from .002 to 1, and storage factor from 1 to 1000. And you don't have to worry about selecting the proper bridge circuit for the various measurements — the instrument automatically makes the correct circuit when you set up for taking the measurement you want. Bridge utilizes Wheatstone, Hay, Maxwell, and capacitance comparison circuits for the wide range and types of measurements possible. And it's self powered — has internal battery and General Radio 1000 cycle hummer. No external generator required — has provisions for external generator if measurements at other than 1000 cycles are desired.

Kit utilizes only highest quality parts. General Radio main calibrated control. General Radio hummer, Mallory ceramic switches, excellent 200 microamp zero center galvanometer, laboratory type binding posts with standard 3/4 inch centers, 1/2% precision ceramic-body type multiplier resistors, beautiful birch cabinet and ready calibrated panel. (Headphones not included.)

Take the guesswork out of electrical measurements — order your Heathkit Impedance Bridge Kit today — you'll like it.

\$6950

Model IB-1B... Shipping Wt. 15 lbs.

Heathkit LABORATORY
RESISTANCE DECADE KIT

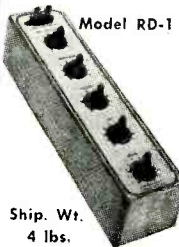

Model RD-1

An indispensable piece of laboratory equipment — the Heathkit Resistance Decade Kit gives you resistance settings from 1 to 99,999 ohms IN ONE OHM STEPS. For greatest accuracy, 1/2% precision ceramic-body type resistors and highest quality ceramic wafer switches are used.

Designed to match the impedance bridge above, the Resistance Decade Kit has a beautiful birch cabinet and attractive panel. It's easy to build, and comes complete with all parts and construction manual.

Ship. Wt. 4 lbs.

\$1950

Heathkit LABORATORY
POWER SUPPLY KIT

Every experimenter needs a good power supply for electronic setups of all kinds. This unit has been expressly designed to act as a HV supply and a 6.3 V filament voltage source.

Voltage control allows selection of HV output desired (continuously variable within limits outlined), and a Volts — Ma switch provides choice of output metering. A large, plainly marked, and direct reading meter scale indicates either DC voltage output in volts or DC current output in Ma. (Range of meter 0-500V DC, 0-200 Ma DC). Instrument has convenient stand-by position and pilot light.

Comes with power transformer, filament transformer, meter, 5Y3 rectifier, two 1619 control tubes, completely punched and formed chassis, panel, cabinet, detailed construction manual, and all other parts to make the kit complete.

LIMITS:
No load..... Variable 150-400V DC
25 Ma..... Variable 30-310V DC
50 Ma..... Variable 25-250V DC
Higher loads..... Voltage drops off proportionally



Model PS-1
Ship. Wt. 20 lbs.

\$2950

Heathkit
BATTERY ELIMINATOR KIT

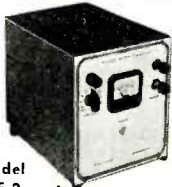

Model BE-2

Ship. Wt. 19 lbs.

\$2250

A few auto radio repair jobs will pay for the Heathkit Battery Eliminator Kit. It's fast for service. The voltage can be lowered to find sticky vibrators or raised to ferret out intermittents. Provides variable DC voltage 5 to 7 1/2 Volts at 10 Amps, continuous or 15 Amps, intermittent.

Also serves as storage battery charger. A well filtered, rugged power supply uses heavy duty selenium rectifier, a husky choke, and a 4000 MFD electrolytic condenser for clean DC. 0-15V voltmeter indicates output which is variable in eight steps. Better be equipped for all types of service — it means more income.

NEW *Heathkit* SINE and SQUARE WAVE
AUDIO GENERATOR KIT

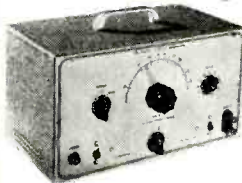

Model AG-7
Ship. Wt. 15 lbs.

\$3450

We proudly present the NEW MODEL Sine and Square Wave Audio Generator Kit. Designed with versatility, usefulness, and dependability in mind, the AG-7 gives you the two most needed waveshapes right at your fingertips — the sine wave and the square wave.

The range switch and plainly calibrated frequency scale give rapid and easy frequency selection, and the output control permits setting the output to any desired level.

A high-low impedance switch sets the instrument for either high or low impedance output — on high to connect to high impedance load, and on low to work into a low impedance transformer with negligible DC resistance.

Coverage is from 20 to 20,000 cycles, and distortion is at a minimum — you can readily trust the output waveshape.

6 tubes, quality 4 gang tuning condenser, power transformer, metal cased filter condenser, 1/2% precision resistors in the frequency determining circuit, and all other parts come with the kit — plus, a complete construction manual. A tremendous kit, and the price is truly low.

TWO HIGH QUALITY *Heathkit* SUPERHETERODYNE
RECEIVER KITS

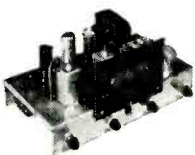

Model BR-1 Broadcast Model Kit covers 550 to 1600 Kc. Shipping Wt. 10 lbs.

\$1950

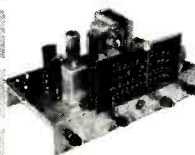

Model AR-1 3 Band Receiver Kit covers 550 Kc. to over 20 Mc. continuous. Extremely high sensitivity. Shipping Wt. 10 lbs.

\$2350

Two new Heathkits. Ideal for schools, replacement of worn out receivers, amateurs and custom installations.

Both are transformer operated quality units. The best of materials used throughout — six inch calibrated slide rule dial — quality power output transformers — dual iron core shielded I.F. coils — metal cased filter condenser. The chassis has phono input jack, 110 Volt output for phono motor, and there is a phono-radio switch on panel. A large metal panel simplifying installation in used console cabinets is included. Comes complete with tubes and instruction manual incorporating pictorials and step-by-step instructions (less speaker and cabinet). The three band model has simple coil turret which is assembled separately for ease of construction.

Heathkit
FM TUNER KIT



Model FM-2

Ship. Wt. 9 lbs.

\$2250

The Heathkit FM Tuner Model FM-2 was designed for best tonal reproduction. The circuit incorporates the most desirable FM features — true FM.

Utilizes 8 tubes: 7E5 Oscillator, 6SH7 mixer, two 6SH7 IF amplifiers, 6SH7 limiter, two 7C4 diodes as discriminator, and 6X5 rectifier.

The instrument is transformer operated making it safe for connection to any type receiver or amplifier. Has ready wound and adjusted RF coils, and 2 stages of 10.7 Mc IF (including limiter). A calibrated six inch slide rule dial has vernier drive for easy tuning. All parts and complete construction manual furnished.

EXPORT AGENT
ROCKE INTERNATIONAL CORP.
13 E. 40th ST.
NEW YORK CITY (16)
CABLE: ARLAB, N.Y.

The **HEATH COMPANY**

... BENTON HARBOR 20, MICHIGAN

Heathkit ECONOMY... 6 WATT AMPLIFIER KIT



\$12.50

Model A-4. Ship. Wt. 8 lbs.

This new Heathkit Amplifier was designed to give quality reproduction and yet remain low in price. Has two preamp stages, phase inverter stage, and push-pull beam power output. Comes complete with six tubes, quality output transformer (to 3-4 ohm voice coil), husky cased power transformer and all other parts. Has tone and volume controls. Instruction manual has pictorial for easy assembly. Six watts output with response flat $\pm 1\frac{1}{2}$ db from 50 to 15,000 cycles. A quality amplifier kit at a new low price. Better build one.

No. 304. 12 inch Speaker.....\$6.95

Heathkit HIGH FIDELITY... 20 WATT AMPLIFIER KIT



Model A-5
Shipping Wt. 15 lbs.

\$21.50

The finest amplifier kit we have ever offered—check the features. This inexpensive amplifier compares favorably with instruments costing five times as much. Nothing has been spared to provide the best reproduction—an ideal amplifier for the new Heathkit FM Tuner.

Dual tone controls for control of both treble and bass. Bass control is of the boost type for maximum listening pleasure. Has inverse feedback to give excellent response over entire range. Tube lineup: 6SJ7 amplifier stage, 6J5 phase splitter stage, two 6L6's in push-pull output, and 5Y3 rectifier.

Has highest quality Chicago Transformer Corp. cased output transformer with taps of 3.2, 8, 15, 60 and 500 ohms to match any speaker combination. Tone control gives maximum bass boost of 6 db at 70 cycles. Amplifier has maximum gain of 75 db. Response within ± 3 db 20 to 20,000 cycles. Complete with all parts, tubes and instruction manual.

Model A-5A. Same as above except that a preamplifier stage with compensation has been added—consists of a 6SC7 and associated components for use with G. E. cartridge or microphone.

Model A-5A, Shipping Wt.....15 lbs. \$23.50

Heathkit RECEIVER AND TUNER CABINETS



\$4.95

Blonde birch veneer cabinet for either of the receivers or tuner. The modern styling is an asset to any room. 5" speaker fits in end of cabinet when used with receivers. (Speaker not included.) Size 7 x 13 $\frac{1}{2}$ x 18 $\frac{1}{4}$ inches. Order No. 345 for either receiver model. Specify No. 350 for the FM Tuner.

Shipping Wt..... 5 lbs.

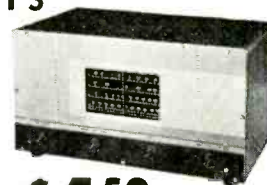

\$4.50

Metal professional type communications receiver cabinet. Finished in deep grey and fits the panel supplied with Heathkit BR-1 and AR-1 Receivers. 5" speaker mounts in end of cabinet. (Speaker and panel shown not included with cabinet.) Gives professional appearance to Heathkit receivers. Size 7 x 14 x 7 $\frac{3}{4}$ inches.

Specify No. 335...Shipping Wt. 6 lbs.



MAIL TO THE
HEATH COMPANY
BENTON HARBOR 20,
MICHIGAN

ORDER BLANK

From _____

SHIP VIA

- Parcel Post
- Express
- Freight
- Best Way

Quantity	Item	Price	Quantity	Item	Price
	Heathkit Oscilloscope Kit — Model O-6			Heathkit R.F. Probe Kit — No. 309	
	Heathkit VTVM Kit — Model V-4A			Heathkit H.V. Probe Kit — No. 336	
	Heathkit FM Tuner Kit — FM-2			Heathkit R.F. Signal Gen. Kit — Model SG-6	
	Heathkit Broadcast Receiver Kit — Model BR-1			Heathkit Condenser Checker Kit — Model C-2	
	Heathkit Three Band Receiver Kit — Model AR-1			Heathkit Handitester Kit — Model M-1	
	Heathkit Amplifier Kit — Model A-4			Heathkit Power Supply Kit — Model PS-1	
	Heathkit Amplifier Kit — Model A-5 (or A-5A)			Heathkit Resistance Decade Kit — Model RD-1	
	Heathkit Tube Checker Kit — Model TC-1			Heathkit Impedance Bridge Kit — Model IB-1B	
	Heathkit Audio Generator Kit — Model AG-7				
	Heathkit Battery Eliminator Kit — Model BE-2				
	Heathkit Electronic Switch Kit — Model S-2				
	Heathkit T.V. Alignment Gen. Kit — TS-2				
	Heathkit Signal Tracer Kit — Model T-2				

On Parcel Post Orders, include postage for weight shown and insurance. (We insure all shipments.)

On Express Orders, do not include transportation charges—they will be collected by the Express Agency at time of delivery.

Enclosed find Check Money Order for _____

Please ship C.O.D. Postage enclosed for _____ lbs.

ALL PRICES SUBJECT TO CHANGE WITHOUT NOTICE

EXPORT AGENT
ROCKE INTERNATIONAL CORP.
13 E. 40th ST.
NEW YORK CITY (16)
CABLE: ARLAB-N.Y.

The **HEATH COMPANY**
... BENTON HARBOR 20, MICHIGAN

GET RID OF B. O.*



in TV Pictures! * BARKHAUSEN OSCILLATION

When vertical black bars appear in TV pictures as shown above they are the result of *Barkhausen Oscillation* occurring in the horizontal sweep output tube (such as the 25BQ6, 6BQ6, 6EV5, 25EV5, 6AU5 or 25AU5 etc.). To correct this difficulty our engineers have developed the

PERFECTION B. O. ELIMINATOR



B. O. ELIMINATOR (Actual Size)

This compact device fits over the horizontal sweep output tube and because it brings a concentrated magnetic field near the source of the Barkhausen Oscillation—namely the screen grid—it usually eliminates the oscillation and the black lines on the face of the picture tube. . . . Service men who have used the B.O. Eliminator say it is the simplest and most positive method of getting rid of the vertical bars that they have ever known. They see a big demand by service men in maintaining the 10,000,000 TV sets now on the market.



EASY TO INSTALL

Just slip the B. O. Eliminator over the tube, move down, or up, or turn until the dark vertical bars disappear from the picture. Spring grip holds the Eliminator in place.

Order Today From Your Supplier!
PERFECTION ELECTRIC CO.
2645 South Wabash Avenue Chicago 16, Illinois
Makers of Perfection Speakers, Ion Traps and Beamauster TV Picture Centering Controls

Jobs are looking for men again!

CREI TRAINING OFFERS PROFITABLE CAREERS IN TV-RADIO-ELECTRONICS

Whether you want a career in the electronics industry, or plan to enter military service, CREI Residence School training is your key to a better job at higher pay.

Important firms like RCA-Victor, Bendix, and United Air Lines use CREI training for their technicians. During World War II CREI trained thousands for the Armed Services.

SEND FOR ILLUSTRATED FREE CATALOG. Get details of course and school, with survey of job opportunities. Classes start twice a month. *Veterans!* Training available under GI Bill. July 25, 1951 is deadline for most veterans. Don't delay! Write now.

CAPITOL RADIO ENGINEERING INSTITUTE
An Accredited Technical Institute Founded in 1927
Dept. 304C, 16th & Park Rd., N.W., Wash. 10, D. C.

DIRECT READING DIFFERENTIAL VOLTMETER

When measuring voltages with the average instrument, it is difficult to measure accurately fluctuations of 10% or less. This direct-reading differential voltmeter measures changes up to $\pm 10\%$ in voltage levels from 1.5 to 150 at frequencies from 20 cycles to 200 kc. It is insensitive to line voltage changes, tube aging, and input frequency within its range.

fier before being applied to the Thyrite bridge.

In this circuit, described in *The Review of Scientific Instruments*, a minimum input of 1.2 volts is required to balance the bridge. The attenuators are used to reduce the input voltage to this level when necessary. Changes in the input voltage unbalance the bridge, thus causing the meter, which may be cali-

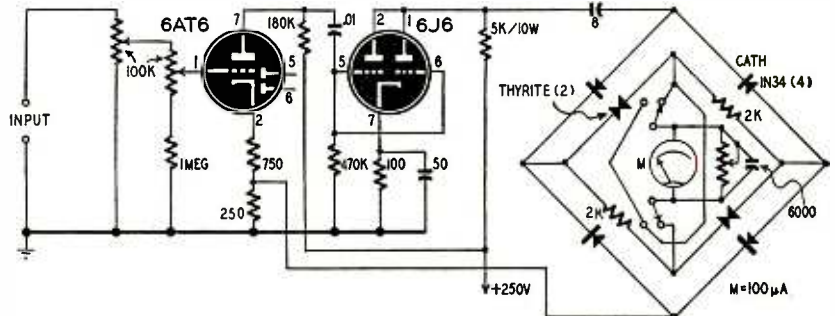

It consists of a two-stage amplifier feeding into a nonlinear bridge composed of two 2,000-ohm resistors and two G-E type 8396839G1 Thyrites. (Thyrite is a nonlinear resistance material which decreases its resistance with increasing voltage.)

The bridge is in the feedback loop of the amplifier to insure high stability and good waveform. The output of the 6J6 is fed to a full-wave bridge recti-

brated directly in percentage of the input voltage, to pass current. The reversing switch permits negative and positive changes to be read. The 6,000- μ f capacitor prevents a.c. from passing through the meter.

The basic full-scale sensitivity of the instrument is $\pm 6\%$. The meter shunt can be installed and adjusted for a $\pm 10\%$ range. Its resistance will depend on the meter resistance.

TRIGGER CIRCUIT FOR SINGLE SWEEP SCANNING

Single-sweep circuits such as that shown in Fig. 3 of "Time Base Circuits" in the December, 1950, issue, can be adjusted to start upon the arrival of a positive or negative signal, but not both. Thus, if the very beginning of an unknown signal is to be observed, the operator must know whether it starts in the positive or negative direction.

degrees out of phase. Both these voltages are coupled to the plates of the 6H6. The positive voltage will pass through its diode and trigger the 884, thus causing its plate voltage to drop and produce a sharp negative pulse.

The deionization switch inserts a .0029- μ f capacitor between the 884 plate and ground. When the capacitor is

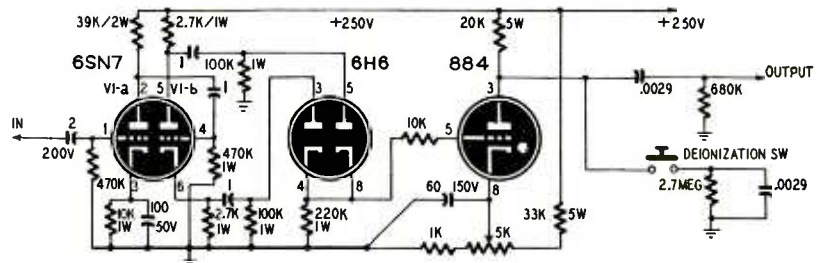

This circuit, which appeared in *The Oscillographer*, is designed to supply a negative trigger to a single-sweep scanning generator in the scope. VI-a is a straight amplifier having a gain of 15, and VI-b is a phase inverter. The voltages across the 2,700-ohm plate and cathode resistors are equal and 180

degrees out of phase. Both these voltages are coupled to the plates of the 6H6. The positive voltage will pass through its diode and trigger the 884, thus causing its plate voltage to drop and produce a sharp negative pulse. This switch may be a normally open or spring-return toggle type.

LOW-COST 6-VOLT D.C. SUPPLY FROM JUNK PARTS

If you are a friend of your neighborhood junk dealer you may be able to pick up an old battery charger that can be converted into a useful 5- to 10-volt d.c. power supply for testing and demonstrating automobile radios. I ran across a junked battery charger and

was able to salvage the stepdown transformer and dry disc rectifier.

The transformer had three taps on the primary winding. We identified the leads, then plugged in the tap which gave the lowest output voltage, and found that the rectifier put out about

10 volts. Turns were removed from the secondary winding of the transformer until about 5 volts output was measured when using the lowest voltage tap.

We used three defective volume controls that still had good s.p.s.t. switches to cut in any one of the taps. This gave a variable voltage output from 5 volts to about 10 volts. A heavy 4-position tap switch can be used instead of separate switches, as shown in the diagram.

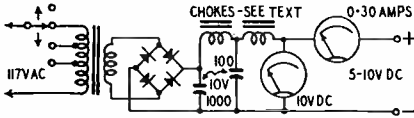

Since this rectifier output has a high 120-cycle ripple in it, a filter was needed to smooth it out. We purchased surplus 100- and 1,000-μf, 10-volt capacitors and then proceeded to fabricate our own filter chokes. For one we used the coil out of an old automobile generator cutout and wound all the No. 12 insulated wire we could on the core of a defective power transformer to make the other one. The laminations for the choke should be butted instead of interleaved as in transformer construction. The 10-volt meter is a surplus unit and the 30-amp meter was salvaged from a junked 1929 Ford.

The rectifier and transformer, designed to deliver up to 80 amps, were rather large and cumbersome, so we mounted them behind the service bench and ran the necessary leads to the meter panel. This setup gives us an economical source of 5 to 10 volts d.c. which will deliver far more current than any auto radio will require. If you are not fortunate enough to find a charger with transformer and rectifier in good condition, you will find winding data on a transformer and filter choke in the article "A-Battery Eliminator" in the April, 1949, issue of this magazine.—John W. Cool

OSCILLATOR MODIFICATION

An annoying hum is often present on the short-wave bands of receivers using tapped oscillator coils like that shown at a. This trouble can often be eliminated by changing the circuit to that shown at b. In this circuit, the cathode is grounded and there is no troublesome r.f. voltage between cathode and heater.

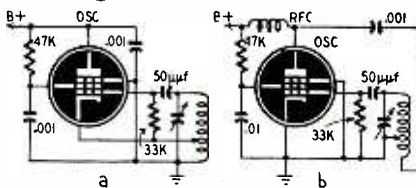

Because the tuning capacitor is across only a section of the oscillator coil in the modified circuit, the oscillator inductance is reduced and the receiver must be realigned. This is simple if the coil is permeability-tuned.

The circuit at b is also the solution to the problem of using tapped oscillator coils with 1R5's, 1A7's, and other tubes which must be operated with the filament at ground potential.—Charles Erwin Cohn

— END —

#630 Super Deluxe 30-tube TV CHASSIS

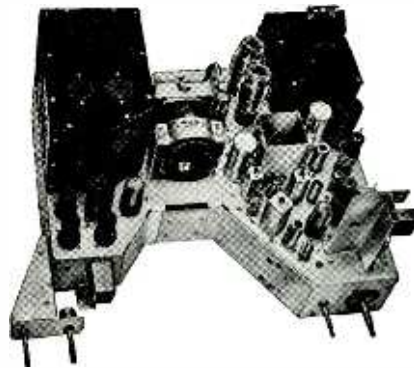

Manufactured in exacting standards with the authentic RCA #630. All chassis are Nickel Plated with molded paper condensers and molded brackets used throughout. AGC . . . STANDARD TUNER . . . LARGER POWER TRANSFORMER.

OPERATES ALL 15", 16", 17", 19", 20" PICTURE TUBES

\$164⁷⁵ COMPLETE ready to PLUG IN AND PLAY

Price includes 12" RCA Speaker, Knobs and Hardware (less CRT)

RECTANGULAR PICTURE TUBES

- 16"—16GP4A \$35.25
- 16"—16RP4A \$39.25
- 17"—17BP4A \$45.25
- 19"—19AP4A or B . . . \$61.25
- 20"—20CP4 \$72.49

Nationally Known Manufacturer • • • Licensed by RCA

#630 PARTS TOP QUALITY LOW PRICES

Standard Turret Tuner complete with tubes	22.49	Brightness & Hold Control Bracket	.59
Escutcheon Plate For Above	.65	Width Control Bracket	.15
Complete Set of Knobs	1.29	Tuner Shaft Bracket	.17
Power Transformer	10.98	Corona Ring	.09
Vertical Output Transformer	2.69	Corona Terminals (Set of 2)	.07
Sound Discriminator Transformer	1.11	Molded Miniature Sockets	.11
1st PIX IF Transformer	1.07	Molded Octal Sockets	.12
2nd PIX IF Transformer	1.07	Cathode Ray Tube Socket & Leads	.39
1st & 2nd Sound IF Transformer	1.01	TV Line Cord With Both Plugs	.29
Synchrolock Transformer	1.49	RCA 12" PM Speaker ALNICO #5	6.89
Filter Choke	1.49	Speaker Connecting Plugs Set of 2	.18
Cathode Trap Coil	1.07	500 MMF 20KV Condenser	.77
Width Control Coil Keyed AGC	.79	.033 MFD 1000V Molded Paper Condenser	.31
3rd & 4th Pix Coils	.39	.047 MFD 1000V Molded Paper Condenser	.31
Filament Chokes	.09	.01 MFD 600V Molded Paper Condenser	.16
Peaking Coil 203L1	.18	.25 MFD 600V Molded Paper Condenser	.39
Peaking Coil 203L2	.18	.0047 MFD 600V Molded Paper Condenser	.15
Peaking Coil 203L3	.18	.047 MFD 600V Molded Paper Condenser	.21
Peaking Coil 203L4	.18	.0022 MFD 600V Molded Paper Condenser	.15
Ion Trap Single	.79	.015 MFD 600V Molded Paper Condenser	.18
Ion Trap Double	.98	.0039 MFD 600V Molded Paper Condenser	.15
Audio Output Transformer (6K6)	.75	.1 MFD 600V Molded Paper Condenser	.25
HV Kinescope Lead (Large Button)	.39	Any 1/2 Watt 10% Carbon Insulated Resistor	.10
Picture & Sound Control	1.14	5000 Ohm 10 Watt WW Resistor	.33
Vertical & Horizontal Control	1.04	1000 Ohm 10 Watt WW Resistor	.31
Brightness Control	.49	40-10 MFD at 450V, 10 MFD-350V Electrolytic Can Condenser	1.49
Horizontal Centering Control	.57	40-40-10 MFD at 450V Electrolytic Can Condenser	1.49
Height Control	.48	20 MFD-450V, 80 MFD-350V Electrolytic Can Condenser	1.29
Vertical Linearity Control	.44	80 MFD-450V, 50 MFD-50V Electrolytic Can Condenser	1.24
Vertical Centering Control	.69	250 MFD-10V, 1000 MFD-6V Electrolytic Can Condenser	1.19
Focus Control	.98	40-10 MFD-450V, 80 MFD-150V Electrolytic Can Condenser	1.29
Flyback Transformer Super Hot	6.98	Bleeder, 50W, 1590 Ohms Tapped at 1360 and 230 Ohms	1.24
Focus Coil 470 ohm	3.69	Bleeder, 50W, 6855 Ohms Tapped at 6750, 93 and 12 Ohms	.87
Deflection Yoke 70°	3.98	Erie Disc Ceramicon .0015 MFD	.13
Chassis, Nickel Plated, Riveted Molded Sockets and Terminals	8.99	Erie Disc Ceramicon Dual .0015 MFD	.19
High Voltage Cage Assembly & Line Cord	4.39		
Voltage Divider Shield & Cover	1.79		
Electrolytic Condenser sub-Chassis	.93		
Sound Discriminator Shield	.18		
Yoke Bracket	.28		
Yoke Mtg. Hood	.57		
Cathode Trap Coil Shield	.39		
Chassis Mtg. Brackets (4)	.43		

All standard tubes available plus other parts. Write for prices.

Minimum Order \$5. Prices subject to change without notice.

TERMS: 25% deposit, balance C.O.D., F.O.B. New York.

TECHNICAL RADIO PARTS CO.

103 Avenue C

Brooklyn 18, N. Y.

TUBES? We have 'em in stock now!

FULLY GUARANTEED

7JP4	\$18.50	6CD6G	4.00
10BP4	24.00	6J5GT	.70
12LP4A	25.00	6J6	2.65
14BP4A	26.25	6K6GT	1.10
16HP4A	33.00	6S4	1.60
16RP4A	33.00	6SA7GT	1.35
17BP4A	34.00	6SG7	1.00
20CP4A	57.50	6SH7	.70
0Z4/0Z4G	.90	6SK7GT	1.35
1A7GT	1.00	6SN7GT	1.85
1B3GT	1.75	6SN7WGT	
1R5	1.40		2.75
1U4	1.00	6SQ7GT	1.35
1X2/1X2-A		6T8	2.50
	1.70	6V6GT	1.60
2B7	1.30	6W4GT	1.45
3Q4	1.10	6W6GT	1.85
5T4	1.95	6X4	1.00
5U4G	1.30	6Y6G	1.10
5V4G	1.90	7C5	1.10
6AC7	1.80	7C6	1.10
6AG5	1.80	7C7	1.10
6AG7	1.95	12AT7	2.40
6AH6	2.65	12AU7	2.00
6AK5	2.95	12BA6	1.10
6AL5	1.30	12BE6	1.10
6AQ5	1.50	12BH7	2.00
6AU5GT	1.95	12SK7	.99
6AU6	1.65	12SN7GT	1.70
6AV6	1.05	19T8	2.70
6BA6	1.45	25L6GT	.95
6BC5	1.50	35C5	1.10
6BE6	1.35	35L6GT	1.10
6BF5	1.75	35Z5GT	.90
6BQ6GT	2.50	50A5	1.55
6BY5G	2.15	50C5	1.10
6CB6	1.65	50L6GT	1.10

PRICES SUBJECT TO CHANGE WITHOUT NOTICE

Make Barry Electronics Corp. your 1951 Headquarters for practically any type of TV. receiving, transmitting and special purpose tube that you may require in small or large quantities.

Maguire De-Luxe Mobile 80-meter mobile AM-Xmtr. Brand new at \$25.00 (orig. factory price at \$69.00)

Terms: 25% with order. Balance C.O.D. Send remittance in full and save C.O.D. charges.

REctor 2-2563

BARRY ELECTRONICS CORP.

136 Liberty Street
New York 6, N. Y.

KEYING MONITOR

Most keying monitors used by amateurs require either special relays, separate power supplies, complex-switching arrangements, or other encumbrances which make them inconvenient to use. The monitor shown in the diagram is simple to construct and easy to get going. It consists of a 6SJ7 oscil-

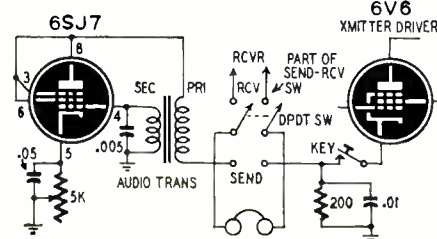

lator with the plate voltage supplied by the drop across the cathode resistor in the keyed stage. The variable resistor in the oscillator circuit is adjusted for reliable oscillator operation under a wide variation of amplifier loading. Headphones are switched from receiver to monitor by a d.p.d.t. switch which is ganged to the send-receive switch on the transmitter or receiver.—Richard L. Bridges, W6PMU

SIMPLE C.W. MONITOR

If you use your receiver as a c.w. monitor, you probably blasted your eardrums whenever you forgot to turn down the gain before transmitting. You've also lost some of the other guy's transmission because you forgot to turn up the gain after turning it over to him. Make two minor changes in your receiver and forget about juggling the gain controls before and after each transmission.

Most sets have the standby switch between B-minus and ground. The sensitivity control or r.f. gain is usually a potentiometer between ground and the cathodes of the r.f. and i.f. amplifiers. Remove the standby switch and short the two leads together. Connect the switch between the low-potential end of the r.f. gain control and ground.

When the switch is open and you are on the air, enough r.f. leaks through to produce a low-level tone in the speaker. In this way, you don't have to touch the gain controls.—Dominic Angelo, W9KGC

ANOTHER TVI ODDITY

I installed my Motorola VT71 TV set in my bedroom after purchasing a large-screen model for the living room. The little set worked fine for a while.

One evening after rearranging the furnishings in the room, I noticed the entire picture weaving from right to left. A check of the sweeps and power supply showed everything to be in order. This strange behavior continued until one evening a week later when I had occasion to pick up an electric clock which had been placed atop the VT71 during the rearrangement of furnishings. As soon as the clock was lifted off the set, the picture returned to normal. Moving the clock to a new location cleared up the trouble permanently.—William H. Deasey

HEATERS IN V.H.F. TUBES

Radio experimenters and constructors should note that filaments of acorn and miniature tubes of the 9000-series should not be connected in series with other tubes of similar current rating, as in the filament circuits of a.c.-d.c. sets. This I learned at the expense of two burned-out acorns.

The burn-outs were apparently due to a voltage surge across the filaments of the acorns. In series with my 955 was a 50L6, whose filament draws identical current but takes longer to heat to normal operating temperature and resistance. Consequently before each tube reached operating resistance, the voltage drop across each filament varied from calculated voltage; and in about 5 seconds, pop went my acorns.

The 9000-series of miniatures, 9001, 9002, etc., also give trouble when connected in series with tubes from other families, but their filaments don't blow as readily as those of acorns.—Bruce Deutsch

ENDLESS WIRE RECORDINGS

With this installation you can play continuously wire recordings of announcements, warnings, bells, chimes, and other material. A rubber-rimmed pulley is grooved to drive the wire without slippage. The speed of the motor and the diameter of the shaft are selected to drive the wire at approximately 2 feet per second.

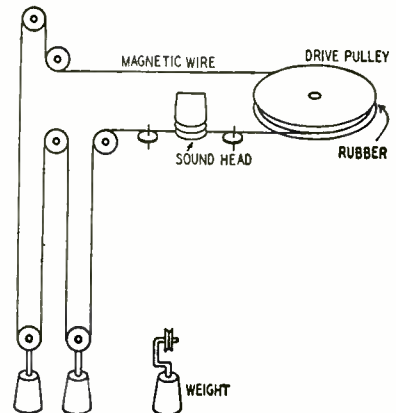

After making the recording on wire, tie the ends together and thread it over the playback head and drive pulley as shown. Small weighted pulleys take up the slack and keep the wire tight so it drives at a constant speed. The sound head works into a suitable amplifier. Almost any length of wire can be accommodated by adding more pulleys and weights.—Jean-Ch. Burkell

GOOD LOW-BAND ANTENNA

In my location, television channels 2 and 5 are weak and 4 is strong. Being unable to find an antenna which would give me optimum performance on these channels, I developed a three-element Yagi that does the trick.

The folded dipole and reflector were cut and spaced for channel 2. The director was cut for channel 5 and spaced 1/10 wavelength (of channel 5) in front of the folded dipole.—H. Harvey

NEAT BREADBOARD LAYOUTS

The appearance of breadboard layout suffers and sometimes dangerous short circuits occur because of loose, dangling leads. To remedy these conditions, tack all long leads to the breadboard with an office stapler. Staples are cheap and easy to remove and are therefore ideal for use in experimental work where the wiring is often changed.—Charles Erwin Cohn

CURING CONVERTER TROUBLES

Sluggishness and drift on shortwave bands are common complaints against converters and shortwave receivers using 6A8 converter tubes. In such cases, try substituting a 6K8. The set or converter will have more pep, and drift will be lessened or eliminated. Corresponding tube elements connect to the same pins, so no wiring changes are necessary when making the change.—Charles Erwin Cohn

TROUBLESHOOTING TV SETS

Troubleshooting a receiver by isolating individual stages is difficult when the tube heaters are in series-connected strings. I solve this problem by saving all defective tubes which have good heaters. I snip off all except the heater pins and use these tubes to replace the good tube in the stage to be disabled. Be sure to mark each dummy tube with its heater voltage and current so you can select the correct substitute for the tube as you put the dummies in the set.—A. F. Hanzl

BATTERY RECEIVERS

If a battery-operated receiver always stops operating before the batteries reach the end of their useful life, try adding a few turns to the tickler winding on the oscillator coil. The increase in feedback voltage will insure oscillation at lower voltages.—Martin J. Brick

NOISY A.C.-D.C. SETS

Several compact midget sets have shown up with noisy, microphonic 35Z5's. It seems that vibration from the speaker causes the coating to flake off the cathode, thus making the emission unstable and erratic.

New 35Z5's are only a temporary cure because the trouble returns in a short time. For a permanent cure, use rubber grommets to shock-mount the rectifier socket on the chassis.—W. Snajberk



"Top floor, please."

Suggested by Arthur A. Henrikson, Chicago 51, Ill.

STANCOR High Fidelity OUTPUT TRANSFORMERS

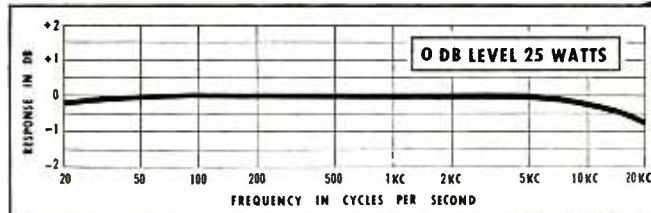

Curve represents an average response of the ten transformers in this series. Units used for this test were drawn at random from current Stancor stock.



±1db FROM 20 TO 20,000 cps

Premium Quality at Low Cost

Stancor has taken advantage of the most advanced design and manufacturing practices to bring you a series of output transformers combining outstanding audio response with very moderate cost.

Extensively interleaved "trifilar" windings, extremely tight coupling, and careful electrical balance result in audio fidelity to please the most critical specialist. An inexpensive, but thoroughly practical, type of mounting is used since elaborate shielding is not required at the audio output power level.

Listed part numbers have a maximum power level rating of 50 watts and provide a wide selection of impedances for popular amplifier applications.

PART NO.	PRI. IMP. (P-P) IN OHMS	SEC. IMP. IN OHMS*	MAX. PRI. D. C. PER HALF	NET PRICE
A-8050	1500	8, 16	200 ma	\$10.86
A-8051	2500	8, 16	150 ma	10.86
A-8052	3000	8, 16	175 ma	10.86
A-8053	5000	8, 16	150 ma	10.86
A-8054	9000	8, 16	100 ma	10.86
A-8060	1500	500	200 ma	10.86
A-8061	2500	500	150 ma	10.86
A-8062	3000	500	175 ma	10.86
A-8063	5000	500	150 ma	10.86
A-8064	9000	500	100 ma	10.86

For complete specifications and prices of more than 450 stock part numbers, including other high fidelity transformers, see the current Stancor catalog. Ask your distributor for a copy or write direct.



STANDARD TRANSFORMER CORPORATION 3592 ELSTON AVENUE, CHICAGO 18, ILLINOIS

WANTED TO BUY

Large and small quantities of new or used electronic government or manufacturers' surplus tubes and equipment. Highest prices paid. State quantity, condition and best price in first letter.

Box No. F-2 c/o Radio-Electronics
25 West Broadway
New York 7, N. Y.

*** SOLAR CAPACITOR ANALYZERS ***

MODEL CBB:—Not just another condenser tester but the best ever made. This is a must for TV Servicing. Will test any and all types of condensers for capacity, power factor, leakage and voltage. Will test resistors from 100 ohms to 7 megohms. Has self contained power supply from 100 to 500 V C D which can be used for external testing. Operates on 115 V 50-60 CPS.



Complete with tubes, test leads & instruction manual; shipping wgt. 9 lbs. \$4249

20% deposit with order. Balance C.O.D.
JOBBER—WRITE FOR DISCOUNTS
ARCEE ELECTRONICS CO.
DEPT. E 96 WARREN ST., NEW YORK 7, N. Y.

HEART  OF A *good* RECORD-CHANGER

It's General Industries' turret-type, 3-speed motor, currently being supplied to record-changer manufacturers.

In this highly efficient design, turntable speeds of 33 1/3—45 and 78 RPM are secured through three separate pulleys mounted on a turret plate. By means of a simple lever, the desired pulley is brought into contact with the idler wheel. The two pulleys not in contact with the idler wheel remain stationary.

In addition to this turret-type motor, General Industries also offers the popular Model TR turret-type, manual 3-speed motor, as well as the Model TS belt-driven 3-speed motor for both manual and record-changer applications. Write today for full information on all models.

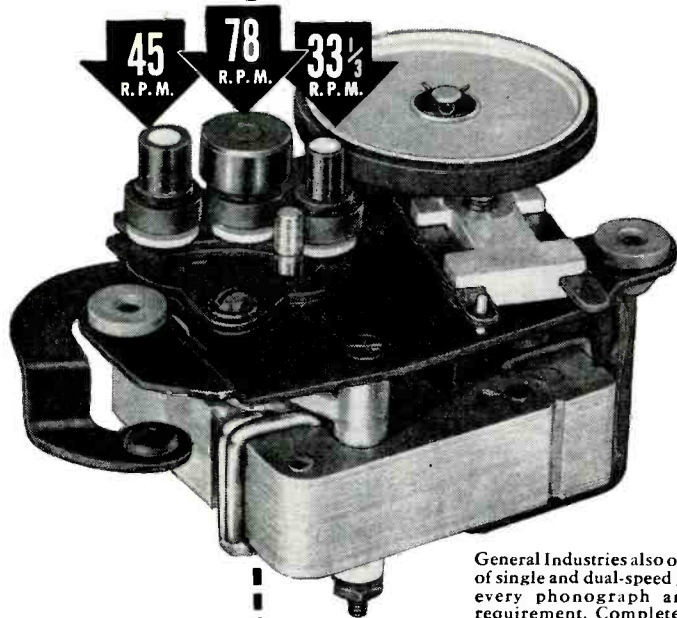

General Industries also offers a complete range of single and dual-speed phonomotors to meet every phonograph and record-changer requirement. Complete details on request.



The GENERAL INDUSTRIES Co.
DEPARTMENT C • ELYRIA, OHIO

TUBES OF THE MONTH

Defense shortages have caused picture tube manufacturers to revert to one of the "pioneer" developments in kinescopes—electrostatic focusing. By eliminating the electromagnetic focus coil, nearly two pounds of copper or a substantial amount of cobalt, both scarce items, are saved on each tube.

The electrostatic types have a new gun design which includes a zero-current focusing electrode that operates at about 22% of the second anode-potential. The focusing voltage is readily obtained from a simple flyback type

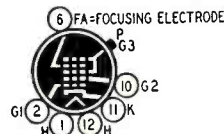

14GP4, 17FP4, 20FP4

power supply operating from the primary side of the horizontal output transformer. A separate rectifier, such as the 1V4, or similar tube should be used, so that the focusing voltage will not be affected by changes in the beam current. Using a dropping resistor or a bleeder across the second-anode supply is not recommended because the regulation is too poor and the focusing voltage would vary with changes in beam current.

National Union has released data on three picture tube types using electrostatic focusing, Hytron has data on one, and RCA and Sylvania are expected, at the time of writing, to have data on their new types soon. The National Union types are 14GP4, 17FP4, and 20FP4, all rectangular. Hytron's tube is also the 20FP4.

The 14GP4 is a 14-inch tube which, except for the focusing, is similar to type 14CP4. It has 70° magnetic deflection and an 11 1/2 x 8 5/8-inch picture. Second anode rating is 14 kv maximum (typical operation is a 12 kv). Focusing electrode voltage is about 2,500.

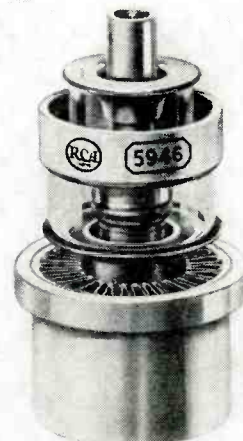

The 17FP4 is designed to replace the 16KP4, 16RP4, and 17BP4-A in new set designs. The focusing electrode operates at about 2,500 volts, and the second anode maximum rating is 16 kv.

RADIO-ELECTRONICS for

ANTENNA MASTS
Immediate Delivery
New Steel Tubing
1 inch O.D. — 20 gauge
10 foot lengths \$1.45 each
5 foot lengths \$.80 each
Special quotations on quantities exceeding 500 lengths.
TERMS: 25% deposit, balance C.O.D., F.O.B. B'klyn
Clarion Metal Products Manufacturing Corp.
557 McDONALD AVENUE
Brooklyn 18, N. Y. Ulster 4-2600

read about "Experiments in Audio" you'll find it in **PF INDEX**
FREE GET YOUR COPY FROM YOUR PARTS JOBBER

Every **RADIOMAN** can use these **SERVICE HINTS!**
Valuable Manual Yours—FREE Write today—no obligation.
FEILER ENGINEERING CO. Dept. 4RC1-1
1601 S. Federal St. Chicago 16, Ill.

Deflection angle is 70° (diagonal), and the picture size is 10¾ x 14¼ inches. Type 20FP4 is a 20-inch tube similar to the 20CP4 except for the focusing electrode, which operates at about 3,000 volts with the second-anode at 14 kv.

Sylvania has released data on a sub-miniature half-wave rectifier, the type 5642, which is designed for high voltage-power supplies where efficiency and compactness are required. The tube wires directly into the circuit, thus eliminating socket leakage and insulation problems. Typical use is in a fly-back type rectifier circuit for television, where two of the tubes in a doubler arrangement can deliver 12 kv to the picture tube second anode. Typical operating conditions for the 5642 are: 1.25 volts at 140 ma on the filament; peak plate pulse from the scanning system, 8,000 volts; and output current 150 µa.

The RCA tube department announces a new compact, forced-air cooled power triode for u.h.f. plate pulsed oscillator and amplifier service. In such service this tube, the 5946, has a maximum rated plate dissipation of 250 watts, and can be operated with full plate voltage at frequencies up to 1300 mc.

The 5946 has a coaxial electrode structure designed for use with circuits of the coaxial cylinder type. The design provides low-inductance, large-area electrode terminals for insertion into the cylinders, and permits effective isolation of the plate from the cathode.

—END—

GROOVE RECORDING ON TAPE

One of the latest German developments in the recording art, the Teflon combines the techniques of tape recording with those of groove recording to give up to 60 minutes of play.

The tape is an endless band of a special plastic, 16 mm wide, which has 56 grooves running lengthwise to give a continuous sound track. A cartridge, dressed up to look like a book, contains the tape. The total weight of the unit is 210 grams (about 7½ ounces).

As the photo shows, the cartridge is fitted on the playback apparatus and the tape is led around a capstan. The pickup head, a replaceable crystal with a sapphire-tipped needle, is then moved up against the tape.

The tape speed is 45.6 cm per second (18 inches per second), and plans are now being made to record on both sides of the tape to double the playing time.

—Claus Reuber



APRIL, 1951

MICHAEL FARADAY

Discoverer of magnetic-electric induction. Inventor of electrical generator. From his name comes the measure of a capacitor—farad.



Famous for Firsts

You can look to Ward for the "last word" in antenna design.

Today's commonly accepted design features—such as nylon insulators, matching phasing links for maximum energy transfer, true broad band response and minute-man quick installation—are all Ward firsts!

Ward aerials are the result of over twenty years of design and production experience. Ward, the oldest and largest exclusive manufacturer, builds the world's finest antennas.

WARD
 WORLD'S LEADING EXCLUSIVE
 MANUFACTURER OF
ANTENNAS

THE WARD PRODUCTS CORP.
 Division of The Gabriel Co.
 1523 East 45th St., Cleveland 3, Ohio

FREE! LATEST ISSUE OF
 "TV SERVICE NEWS"
 Yours For 3¢ Postage

Now! Get your FREE copy of TV SERVICE NEWS have latest TV data at your finger tips!

This valuable bulletin gives you practical time- and money-saving TV servicing short-cuts, up-to-minute service techniques, facts on TV circuits and system plus many other helpful details. Easy to read. Illus- trated. A valuable, practical guide for "old-timer" TV servicemen, be- ginners, students. Latest issue is yours FREE!

ACT NOW! Get FREE copy. Mail name, address and 3¢ stamp for postage. Offer limited. WRITE TODAY!

TELEVISION COMMUNICATIONS INSTITUTE
 205 W. Wacker Dr. Dept. 200 Chicago 6, Ill.

NEW CONDENSER TESTER

**Finds Intermittent
 Condensers Instantly**

Pres-probe's sliding tip with variable resistance prevents condenser heating. Tests with power on. Requires no adjustment. Stops guesswork. Saves time. Convenient probe size (7¼" long). Satisfaction guaranteed.

795
 Postpaid U.S.A.

See Your Dist. or Order Direct

PRES-PROBE CO.
 2326 N. THIRD ST., MILWAUKEE 12, WIS.

Commissioner be appointed, who in his own discretion may promulgate such rules as may seem to him to be for the benefit of the industry and the television-viewing public. Thus the regulations—enforceable by suspension or cancellation of the service technician's license—might conceivably depend on the whim of the Commissioner.

Another objection urged against the proposed bill was that though a number of weaknesses in the television servicing situation were mentioned in the bill, it made no specific provision (other than appointment of a Commissioner) to correct them.

A number of methods of combatting the bill were discussed. These included pressure for a public hearing, making contact with councillors in person or by letter, and educational work among television owners, who would in the long run be victims of any system which would add to the expenses of the television service technicians.

TCA HOLDS ELECTIONS

The Television Contractors Association, of Philadelphia, has re-elected Albert M. Haas to serve as president for the 1951 term. Also re-elected were Samuel A. Whittingham, vice president, and Jack Phillips, secretary. Joseph F. Griffin succeeded George F. Weber to the position of treasurer.

Haas, in accepting his office, declared he would do everything in his power to raise the standards of the industry in Philadelphia and work in conjunction with other leaders throughout the country. He asserted that there were many things in the industry that need correction, but that the manpower shortage is the most pressing problem. He advocated an industry-wide educational program of an in-plant nature.

- END -

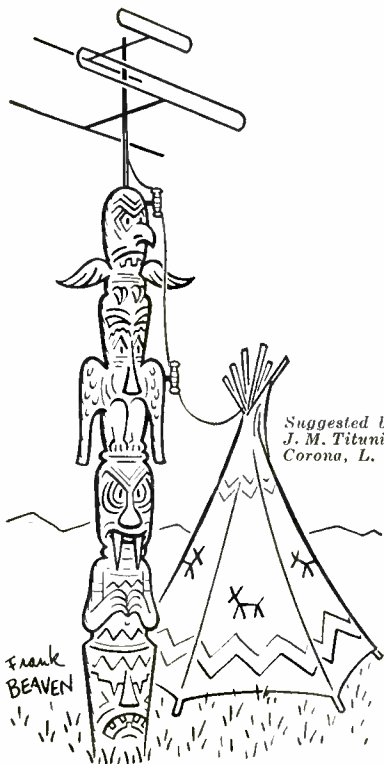

Suggested by J. M. Titunik, Corona, L. I.

Frank BEAVEN

BE SURE YOU HAVE ALL THE TOP VALUES FIRST

- in radio
- television
- electronic equipment



FM-AM BASIC KIT

Exclusive Concord Basic FM-AM Kit. Save by building your own 8-tube (includes rect.) FM-AM tuner or 11-tube (includes rect.) complete chassis. Both include phono preamp for GE reluctance cartridge. All major basic parts supplied... You get:

- (1) 3 Gang FM-AM Condenser
- (1) FM Oscillator Coil
- (1) FM Dipole Antenna
- (2) AM IF xformer
- (1) FM Antenna Coil
- (2) FM IF xformer
- (1) AM Converter Coil
- (1) AM Loop Antenna
- (1) FM Converter Coil
- (1) FM Ratio Detector
- (1) AM Oscillator Coil

Easy-to-follow schematic diagram and a complete list of all necessary parts for finishing your tuner or chassis are also included. This way you're able to utilize parts you already own and make double savings. At this low price these lots won't last long, so order yours TODAY. 99-5075J-Shpg. Wt. 4-1/2 lbs. Net. **6.95**

HI-FREQUENCY ANTENNA



Hi-Frequency Antenna...originally used with BC 645...readily adaptable to Citizens Band Radio. Covers frequency range 435 to 500 mc. Element length 5-1/4". Ready to mount... includes coax cable connection, mounting plate and gasket. Requires 7/8" hole. Mounting center 1-3/4" x 7/8". Optimum operation is provided by using 1 each for transmitting and receiving.

99-9413J... 2 for 1.75... Singly... **95c**

SOUND POWER PHONES

Pair of Sound Powered Phones selling at unheard of low price. Serves as complete 2-way communication system. Ideal for use while installing radio and TV antennas.



99-7053J... Pair... **5.95**
2-conductor #19 twisted pair, wire for above.

19-20895J... 100' for 2.50... per ft. **3c**

TV GUY WIRE

Extra Strong Stranded Cable. Will withstand 350 pound test. Small size and snarl-resistant qualities make it ideal for use as antenna guy wire, captive ballon anchor cable, dial cable, etc. Originally used as aircraft control wire. Consists of 21 strands alloy brass plated to resist corrosion. 1/32" overall diameter.



99-5147J... Lots of 5000 ft, per M. **3.50**
Per 1000 ft. 3.95

SEND FOR CONCORD'S NEW BUYER'S GUIDE

The best possible way to get great bargain scoops first hand... The new CONCORD BUYER'S GUIDE. Don't miss an issue.

Complete Listings of Available Merchandise

Current Low Prices ● Prompt Expert Shipment



FREE

CONCORD RADIO CORP. Dept. JD-51
901 W. Jackson Blvd., Chicago 7, Illinois.

Rush me your Latest Buying Guide

Name.....

Address.....

City..... Zone..... State.....

CONCORD RADIO

"WHERE THE WORLD SHOPS"

901 W. Jackson Blvd., Chicago 7, Ill.

Get Your Free Copy TODAY

EXPORT

For PROMPT Service on Export Orders & Inquiries Address to CONCORD RADIO CORP., EXPORT DIVISION, 901 West Jackson Blvd., Chicago 7, Illinois.

EFFICIENCY IS THE KEYNOTE!

NEW DRIVE FOR PRODUCTION EFFICIENCY MEANS NEW DEMAND FOR INTER-COM SYSTEMS!

Model HU-15V HU-24V



The model HU-15V is a medium sized speaker suitable for all paging and talk-back applications. All ATLAS paging speakers are designed to offer a maximum sensitivity in talk-back systems. The weather proof universal line matching transformers are easily attached to any model. Designed for constant impedance, constant voltage systems and 50 ohm lines. The model HU-24V is an oversized speaker having the obvious advantage of a longer air column length. Suitable for music as well as speech in industrial applications.



Our expanding anti-aggression effort calls for quick conversion of many plants to war production. New levels of efficiency must be attained.

For full efficiency, a modern inter-com and paging system is a must.

The demand for good sound equipment will be heavy. Will you be ready? NOW is the time for you to establish yourself as a dependable source of industrial electronic equipment.

ATLAS can help you build a profitable sound equipment business. We are ready to supply you with equipment to meet every conceivable inter-com and paging requirement.

Model TP-15V . . . TP-24V

The TP type speakers are available in two sizes. These dual two-way speakers produce two speaker results from a single location for long corridors, hallways, etc.

All ATLAS speakers are priced Right! COMPARE! But remember, we make no compromise with quality.

Don't miss your best new business opportunity in years. Write us TODAY for full details.

ATLAS Sound Corp.

1443—39th Street, Brooklyn 18, N. Y.

Canada: Atlas Sound Corp., Ltd., Toronto, Ont.

MODIFICATION FOR G-E 800

This receiver and similar models can be modified for automatic black-level d.c. restoration by removing the 6AL5 and rewiring its socket for the 6AU6 black-level amplifier. 1N34 germanium crystals replace the detector and sync-clipper diodes. A third 1N34 is installed in place of the 6AL5 as the black-level d.c. restorer.

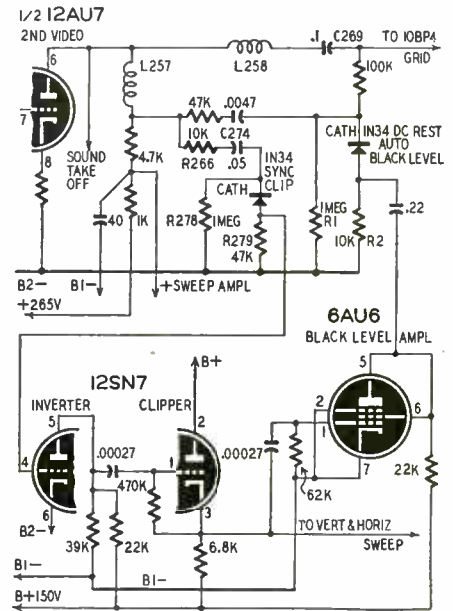

The 6AU6 amplifies the negative sync pulses to a level higher than those appearing in the video output. These amplified pulses are applied to the anode of the d.c. restorer diode and cause it to detect at the black level or pedestal rather than at the sync tips as in the more conventional circuits. The voltage developed across R1 is a function of pedestal height and not the sync tips. It may be necessary to juggle the value of R2 until you get optimum performance.—Wilbur J. Hantz

TESTING 1N34 GERMANIUM DIODES

Type 1N34 germanium diodes are used as video detectors in a number of TV receivers. To check them, measure the forward and backward resistances with a standard ohmmeter. They should be replaced when the back-to-front ratio falls below 100 to 1.—Du Mont Service Notes

MOTOROLA TS-14 AND TS-23

Most cases of insufficient picture height can be traced to heating of the .05-µf, 600-volt charge-discharge capacitor C-70 connected in the plate circuit of the 6J5-GT vertical sweep-generator tube. This capacitor is located between the chassis and the filament transformer for the 6W4-GT damper tube.

When replacing this capacitor, anchor one end on pin 6 of the 6W4-GT socket and then connect it to the plate of the 6J5-GT. Connect the other end to the ungrounded end of R-56, the 8,200-ohm resistor associated with it. The new location is cooler and the capacitor will be less likely to change its value.—Yuki Minaga

The New GONSET FM COMMUNICATIONS TUNER

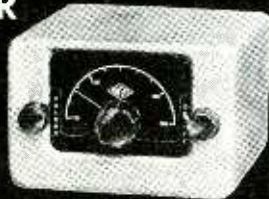

PROVIDES A SENSITIVE RECEIVER FOR 2 WAY FM RADIO-TELEPHONE COMMUNICATIONS

- Excellent for mobile or fixed operation
- Used with your auto or fixed radio
- Receives police, fire, taxi, etc.
- Compact (5 1/4" x 3 3/8" x 5 1/4")
- High sensitivity
- 5 tubes

\$59.50 net

Models available
30-40 MC
40-50 MC
88-108 MC
152-162 MC



see your distributor or write direct

GONSET CO., BURBANK, CALIF.

Leotone

Push-Back Hook-Up Wire . . . Red, blue, yellow, black; #20 Stranded—100 ft./\$.95; #24 Stranded—100 ft./\$.79; 1000 ft./\$5.95

- Hearing Aid-Type Cable . . . Rubber covered tinsel; twisted, outside silk braid—2 wire (1/16" O.D.) . . . 100 ft./\$1.69 \$15/M; 3 wire (3/32" O.D.) . . . 100 ft./\$2.19 \$20/M; 115V. AC Bell . . . 3" brass, plated, Brand new . . . \$1.39; 4 Wire Flat Cable . . . #16 strand, gray rubber, zip-type, 1/8"x1/2". For TV Rotors, bus work . . . 6c ft.; 100 ft./4.95
- BC-606 Interphone Control Box . . . brand new69
- BC-1366 Switch Box . . . like new, best knobs75
- TU-17 Tuning Unit (BC-223) . . . 2-3Mc. like new . . . 2.49
- AY-38D Selsyns (Bendix) . . . 110V, 400 cycle . . . 1.95
- RG-13/U Co-Axial Cable . . . 74 ohm; 20 ft. lth. & cons. . . . 1.39
- AC-DC Blower (Delco) . . . 3", 24 blade impeller; less housing, 3400 RPM, 27V, 1 1/2A, 2 1/2" dia. . . 3.95
- 5" Speaker Baffle . . . 1/2" masonite . . . 13c 6/1.00
- Generator Voltage Regulator (GBD-1A-18) . . . 24 cont. adj. relay, shock-mtd. . . 4.48
- Midget Plug & Jack . . . PL-241/48 . . . 39c 6/1.95
- Radio Hardware Treasure . . . FULL POUND of Nuts, Screws, Washers, Locks in CAN. . . .69c 3 lbs.—1.98
- 1/2" Glossy Black Bakelite . . . 6"x7"; 45c; 6"x8"—49c; 6"x10"—59c; 6"x12"—69c.
- Aluminum Panel (.051) . . . 11 1/2"x18" 1.39
- Microphone ANB-M-21 . . . magnetic, 1 1/2" cord & PL-29198
- T-30V Throat Mike . . . brand new49c 6/2.45
- CD-508 Ext. Cord & Switch for T-30 6/2.45
- T-44A Magnetic Mike (SCR-522) . . . complete, new75
- Handy Carbon Mike (RS-83) . . . Press-to-talk . . . 1.39
- High Fidelity Crystal Microphone (Delco) . . . 100c
- rubber mtd. 1 1/2"x1/2". Less housing 1.29
- Aluminum Housing for crystal mike 15
- Tube Carbons . . . Plain white (Delco) per 1000; Min. (1" sq-x2 1/8")—\$1.20; GT (1 1/2" sq-x3 1/4") Med. (1 1/2" sq-x4 3/8")—\$1.65; Large (2" sq-x5") P-23 Header . . . 5 ft. cord & PL-55 . . . 1.98
- Rubber Phone Cushions pair 2.95
- HB-7 Headbands . . . lthr., 13" cord, PL-54 . . . 39c 6/1.98
- HB-1 Headbands . . . thumbscrew adjust. 39c 6/1.98
- HB-30 Headbands for HS-30 Phones . . . 13c 6/1.00
- HS-30 Matching Transformer (C-410)45
- DPDT Toggle . . . 20A/125V. BAT. Spring act. . . 35
- Moulded Bakelite Condensers (Micamold)00001 to .2mf. 200-600V. 50 asstd. \$1.98
- !!Special!! . . . 150 MMFD. MICAS. (MICAMOLD) 7/16"x1/16" pigtail 100/\$4.75 1M/\$32.50
- Rotary Selector Switches . . . incl. multi-deck, multi-contact. Kit of 6 asstd. . . . 1.49
- Resistors . . . carbon, w.w. ferrule-end, 25 asstd. Experimental Tubes . . . for Test, Research. Fil. tested, 20 asstd. recvg. types 1.00
- Wire-Wound Resistors . . . 5-20W. 15 asstd. . . .98
- Alnico Magnet Kit . . . powerful Block, Bar, Rod, etc. Kit of 10 asstd. . . . 1.98
- (WRITE FOR "ALNICO MAGNET" SUPPLEMENT)
- Voltage Divider Kit . . . 10-50W. 10 asstd. . . 1.98
- Speaker Repair Kit . . . Liberal assortment of parts
- Speaker Cones . . . 4" to 12" incl. free-edge. Less voice coils. Kit of 12 asstd. . . . 1.98
- Speaker Repair Kit . . . Liberal assortment of parts
- Rings, Shims, Cement, Chamols Lthr., Felt, V.C. forms & Instructions 2.45
- !!Special!! BOTH CONE & REPAIR KIT 8/1.98
- Min. Order \$3.00 . . . 20% deposit on all COD's

Please add sufficient postage—excess refunded Full remittance with foreign orders

LEOTONE RADIO CO.
67 Dey Street,
New York 7, N. Y.

DU MONT RA-111A

In some fringe-area installations, it is necessary to make minor changes in these sets to improve sensitivity or signal-to-noise ratio. Replace the first and second video i.f. tubes (6AU6's) with 6BC5's. If this change does not produce the desired results, make the following alterations in the order shown:

1. Replace the fourth video i.f. with a 6BC5.
2. Remove the ground connection from pin 2 of this socket.
3. Replace transformer Z208 with a new transformer, part No. 2000-5241.
4. Realign this stage using procedures described in the manufacturer's instructions.

If these changes cause regeneration in the video i.f., make these additional changes:

1. Connect a 68,000-ohm, 1/2-watt resistor across terminals 1 and 2 of Z208.
2. Remove the .005- μ f capacitor from pin 4 of the 6T8 and connect it between the ungrounded heater pin of V207 (the third video i.f.) and ground.
3. Redress and shorten the lead from R237 and C276, in the cathode circuit of the video amplifier V210, to the contrast control R239A. Keep this lead away from the Inputuner.
4. Disconnect the filament lead which runs from the first video i.f. (V205) to the filament tie point of the Inputuner. Reconnect heaters of V205 and V206, connecting the ungrounded heater pin of V206 (second video i.f.) to the ungrounded heater pin of the third video i.f. (V207).

The diagram shows the rerouting of the contrast control lead and the modification of the heater circuit.—*Du Mont Service Notes*

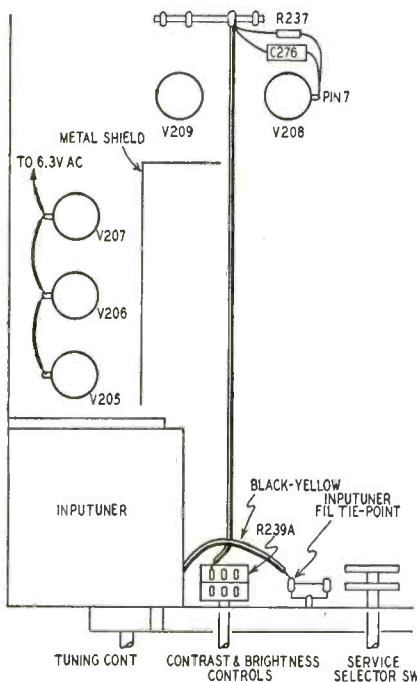

FINEST FOR FRINGE AREA RECEPTION—1952 MODEL

30 TUBE 630 CHASSIS

ADAPTABLE FOR COLOR

THE PERFECT CHASSIS FOR

16"-17"-19"-20" PICTURE TUBES

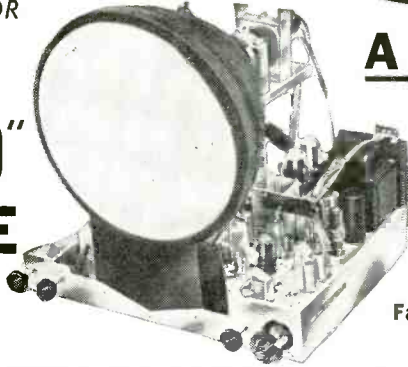

LIC. UNDER RCA PAT.
A SET

CHASSIS MOUNTING BRACKETS FOR TUBE

\$4.95

RMA & AIREX

Guarantee Factory wired, aligned & tested.

\$159⁹⁵
Without Cathode Tube With Hi-gain Standard Coil Tuner and 5"x7" Speaker Complete with all Federal taxes

Thousands of our 16", 17", 19" & 20" sets are giving new viewing thrills to TV watchers all over the country. This extra powerful super chassis is designed to bring in sharp, clear pictures, even in fringe areas. Works in most areas on only an indoor antenna. Has Improved Keyed ACC; Full 4 Megacycle Band Width; 16 KV output; 3 stage SYNC Separator & clipper; Moulded Plastic Condensers; Uses new Mark Transformer; 5-Four Min. Heat Run at Factory; Improved high gain front end, down to 45 microvolts; Synchro Lock; Freedom from arcing & corona leakage; Armstrong FM Sound System; Improved linearity adjustment & second horizontal linearity control. Phono connection and switch for record player on chassis.

AVAILABLE with DUMONT INPUTUNER FM RADIO & \$169⁹⁵ 5"x7" SPEAKER

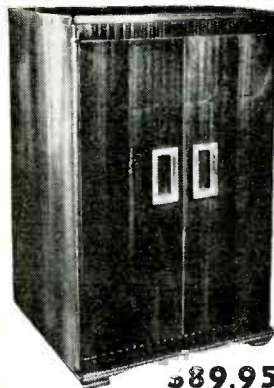

\$89.95

A PRICE-SMASHING VALUE IN TV CABINETS FOR THE 630 CHASSIS

Full Doors for 16"-17"-19"-20" Picture Tubes | Without Doors for 16", 17", 19", 20" Picture Tubes

Beautiful, richly finished, hand rubbed mahogany cabinets specially designed to house the 630 chassis with a 12" speaker. A perfect picture deserves a perfect cabinet. It will be a focal point of beauty in your home. 40" high x 24" x 24". All complete with brackets, mask & hardware. Above cabinets in blond—\$10 EXTRA.

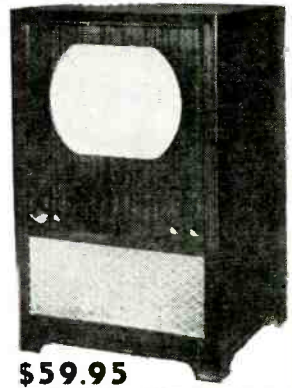

\$59.95

TV MASKS, 16"-17"—\$4.95; 19"-20"—\$7.95 | 12" R&A HI-FI SPEAKER—\$5.95

TV TUBE SCOOP

- All Black, Glareless Sheldon, Zetka & TRL
- 14" rectangular \$24.95
 - 16" rect. or round 37.50
 - 17" rectangular 39.50
 - 19" round metal 57.95
 - 20" rectangular 59.95

All Tubes Fully Guaranteed for 6 Months
DuMont TV Tubes In Stock

REGENCY BOOSTER

MODEL DB-410



Improves reception in Low Signal Areas. All channel tuning. 1 knob control. Turns set on and off.
\$19⁸⁷

Also McMurdo Silver Booster.

RECORD CHANGER

SALE

\$32.95

WEBSTER 3-SPEED

CHANGER

Plays 12 records automatically. All sizes. All speeds. 33 $\frac{1}{3}$ -45-78 RPM. Permanent point needle. In original carton. Reg. \$48.00



All merchandise is brand new, factory fresh & fully guaranteed. Mail & phone orders filled upon receipt of certified check or money order for \$25 as deposit on TV chassis. 20% on other items. Balance C.O.D., P.O.B., N. Y. Prices subject to change without notice. No additional taxes to pay.

AIREX RADIO CORP.

171 WASHINGTON ST., N. Y. C. 7, N. Y. Worth 2-4029; Worth 2-9578

ADAPTERS

for 5 U 4 Tubes to replace with 80 or 5 Z 3 Tubes
List \$1.25
your cost 75 cents each.

HARMONIC MFG. CO.
224 Livingston Street Brooklyn 2, New York

ANOTHER OUTSTANDING JOBBER

ISLAND Radio Distributors, Inc.
412 Fulton Avenue
Hempstead, L.I., N. Y.



\$25.95

HAS THE SENSATIONAL NEW
EICO 1040-K BATTERY ELIM. KIT
IN STOCK!

TV CONVERSIONS

COLOR & BLACK and WHITE

Latest and authoritative 35 page booklet giving complete information, schematics and detailed drawings on how to convert your present TV set to COLOR or to a BIG 16" or larger screen. Send \$1.00 and receive your booklet postpaid. Write for FREE parts list.

COLOR TELEVISION LABS.
1638 Westchester Ave., Dept. RE-1 Bx 60, N. Y.

Specialized Service Men

CRYSTALS FOR LESS! If you are servicing aircraft, marine, police, mobile or industrial radio you may be entitled to our SPECIAL DISCOUNT on highest quality quartz control units. Write for full details . . . it will mean money to you!

RADIO SPECIALTY MFG CO. Dept. RE
2023 S.E. Sixth Ave. Portland 14, Oregon

BUFFALO RADIO SUPPLY

219-221 Genesee St., Dept. RE 4
Buffalo 3, N. Y.

High Fidelity Fans • Public Address Men
MAGNAVOX AMPLIFIERS

30 watts output High Fidelity Includes Broadcast quality input pushpull transformer in heavy steel case. Double pushpull—6 tubes included.

Put this on that hi-fi tuner or phono job that has never quite come up to expectations and thrill to the same performance that you would get from a \$500.00 combination by one of America's most quality conscious manufacturer.

You probably recognize that practically every TV set made has audio reproduction inferior not only to a console model radio but even to a cheap table model radio. This seems true regardless of the price of the TV set. TV sets of all makes are apparently made for the tin-eared listeners. What a difference you can enjoy with an amplifier like this made by a quality-conscious organization for the golden-eared hypercritical lovers of the finest in music.

First come, first served with this terrific bargain. Only 300 Magnavox 30 W. amplifiers complete with 6 tubes for \$25.00 apiece. No more to be had even at ten times this fantastically low price when our stock is gone. Hurry—order now—don't delay and have vain regrets later.

MAGNAVOX DIVIDING NETWORK

for high frequency speakers. Calculated crossover frequency for 50% of power to each speaker 400 cycles. Calculated crossover for distribution of 2/3 of the audio output to woofer and 1/3 total output to tweeter is 800 cycles. Included inductance and capacity sections. 4 to 16 ohm input impedance usable with any speakers. Will handle up to 120 watts of audio power. Similar equipment is catalogued by other manufacturers up to \$35.00. Your special bargain at \$3.00 complete with nothing else to buy.

HIGH FREQUENCY TWEETER SPEAKERS

For use with any cone speaker to produce a dual speaker combination with frequency range up to the limit of audibility of the human ear. Cone speakers seldom reproduce effectively above 6500 cycles. Even low priced amplifiers far exceed this range and, in fact, always have at least some output up to the limit of audibility. These professional type famous name tweeters offer the opportunity to get extended range quality reproduction at lowest cost. Can be connected to the voice coil of any cone speaker through a simple high pass oil condenser filter costing \$1.00, or better yet our crossover network, costing only \$3.00 can be used to supply both speakers. Suitable for home or theatre. Specs: 8 ohms, 10 oz. Alnico 5 magnet, 100% by 5/8" 50° distribution angle. 800 to 15000 cycles. Your cost \$11.00. **QUANTITY LIMITED!!!!**



GENERAL ELECTRIC 15 TUBE TRANSMITTER-RECEIVER SET. This brand new 15 tube transmitter-receiver was designed for mobile, low storage battery powered service. It's a cinch for the experimenter to connect this unit for 110 volt A.C. operation by following the instructions and diagrams supplied which cover numerous applications, including FM and amateur television transmission and reception. For those intending to use on car or boat, a new dynamotor, exactly as originally supplied, costs only \$15.00. Don't fail to write for FREE descriptive bulletin. Order our RT-1248 for only \$29.95, or two at \$53.90.

PORTABLE PUBLIC ADDRESS AMPLIFIER

Brand new Portable public address system complete with speaker, mike, tubes and everything, in classy looking airplane luggage covered portable case with genuine leather handle for the important man. Cost of \$29.95 complete. Order a half dozen, rent them out for only \$3.00 a day apiece, and enjoy an income from that source alone of \$6540.00 a year. BUT, make certain that you get a substantial deposit on each rental, because these jobs are so snazzy looking that many customers will be tempted to lose their deposit and keep your amplifier.



WE ARE LOOKING FOR TUBES

and other surplus. Large or small quantities. Send your list for our bid.

SPECIAL

50 M.M.F., 24 plate variable cond., 29c or 5 for 99c

We especially want BC654 and SCR284 components

AUDIO AMPLIFIER—Brand new, Push-Pull stage triode amplifiers having 2 of the valuable and scarce output type audio transformer that sell for over \$10.00 each. Neat aluminum case, fully enclosed (largest dimension 6 inches). Perfect for intercom system, phono amplifier, mike amplifier or signal tracer amplifier for testing radio sets. A sensational bargain at only \$3.40 each

Tri-Purpose

35 MM Slide Projector and Enlarger

Most terrific photographic bargain opportunity of the 20th century.

- A fine precision instrument with many features.
 - Takes roll film or 2x2 slides
 - Automatic Slide Changer furnished
 - No more waiting for enlargements to enjoy your candid shots. All you need is a flat surface to project on
 - Has 300 W 110V Bulb, 6V, 12V, 32V or 220V available
 - Heat absorbing filter
 - 8 precision-ground optical glass elements in optical system (No other projector on the market has more)
 - Automatic rewind on film
 - Use as an enlarger for making your own prints of any desired size
 - Plano-Convex Meniscus Condenser
 - 5" focus Brown-Violet coated double anastigmat lens
 - Swivel projector head
- Brand New Society for Visual Education Model AAA Projector. Regularly \$80.00; Super Special \$40.00. Quantity Limited.

CROSLY TV RECEIVERS

To prevent breakdown between the plate leads of the 6BG6-G and the damper tube, install 3/4 inches of Fiberglas sleeving (part No. 39468-14) over the 6BG6-G plate lead toward the terminal on the horizontal deflection transformer.

A few of the models 10-414 and 10-416 produce an unstable picture because of an incorrect connection in the a.g.c. system. If this condition is encountered, check the polarity of the connections between the horizontal deflection transformer T-107 and the a.g.c. amplifier tube V-107B. The two leads from the transformer lugs 9 and 10 to pin 6 of V-107B and to the junction of R-156 and C-114 may need to be reversed.

To determine if the leads are correctly polarized, connect a scope from the plate (pin 6) of V-107B to ground. A positive pulse will be observed if polarity is correct. If unknown, check polarity of the scope with a battery across the vertical input terminals.

Early sets of the 1950 line were equipped with a 6AK5 mixer tube. To replace this with a 6CB6, solder socket lug No. 7 to the chassis. Later sets have a 6CB6 mixer. 6AK5's can be used in these sets without alterations. —Crosley Service Dept.

UNUSUAL TVI

Sometimes when tuning the low-band TV channels, a single barber-pole horizontal stripe will drift slowly up and down the picture. This effect is generally seen in weak-signal areas, in the evening when more lights are on.

This trouble is usually caused by a bad light bulb, but it can also be caused by a high-resistance contact between bulb and socket. Locate the bad one by turning off each light until you find the one which is causing the trouble. If a new bulb doesn't stop the interference, try burnishing the base of the lamp and the socket. —William J. Wegge

TUBE VARIATIONS AFFECT VIDEO I.F.

The relatively slight variations that exist between tubes of different makes are important in weak-signal areas where maximum gain is desirable in the video i.f. stages of some Westinghouse sets. The use of some makes of 6CB6's in the V-2170 chassis can cause the i.f. gain to be reduced to about one-half (6 db). Use 6CB6's made by RCA or Raytheon as replacements in the video i.f. strip when maximum gain is required. Tubes of other makes perform satisfactorily in other circuits.

The bandpass of the video i.f. system is affected somewhat by the characteristics of the 6AL5 used in the video detector circuit. Tubes with excessively high permeance cause the i.f. response curve to be round-topped with a narrow bandpass. This condition is particularly undesirable in fringe areas.

For best results in the Westinghouse V-2172 chassis, use Raytheon 6AL5's as replacements for the video detector. Other 6AL5's are satisfactory elsewhere. —Westinghouse Service Hints

— END —

"NO BOOK

in two generations, no book since Jules Verne, has undertaken to do what Hugo Gernsback in the first decade of our century has here so outstandingly achieved."

LEE DE FOREST
Father of Radio



Forty years ago, Hugo Gernsback, Father of Modern Science Fiction, in this book, RALPH 124C 41+, predicted and described in startling detail, radar, the learn while you sleep method, television, televised operas, plastics, night baseball, blood transfusion, wire recording, micro film and a host of other scientific achievements—all undreamed of in 1911—but part of everyday life today.

All of these and scores more, not as yet realized, are found in his remarkable prophetic book. For Hugo Gernsback's prophecies are based not on fantasy but on the logical projections of established scientific facts.

RALPH 124C 41+ is the first and most remarkable true science fiction novel ever written! A whacking good adventure story that takes place in 2660 AD—but it is far more than fiction!

To technically minded people, RALPH 124C 41+ is the most complete and accurately documented catalog of scientific prophesy ever published. It was originally written in 1911 and published in book form in 1925. Now, because of its tremendous importance as a work of accurate, scientific prediction of the future, it has been reissued in a new second edition.

Hugo Gernsback's writings were the spark that started many of today's top radio engineers and scientists on their way. Now again, this new edition of RALPH 124C 41+ may well be the inspiration for a new generation of pioneers of science.

RALPH 124C 41+ is the kind of book you should read. Order your copy now, only \$2.50 postpaid. The supply is limited.

RADIO PUBLICATIONS

25 West Broadway New York 7, N. Y.

MAIL THIS COUPON TODAY

RADIO PUBLICATIONS
 25 West Broadway, New York 7, N. Y.
 Gentlemen:
 Send me a copy of RALPH 124C 41+ postpaid,
 at once. My remittance of \$2.50 is enclosed.
 NAME.....
 STREET.....
 CITY.....ZONE...STATE.....

SPECIAL OFFER!

IMPORTANT

RADIO-ELECTRONICS offers regular readers a chance to subscribe at these unusually low rates this month:

3 YEARS \$5.50
2 YEARS \$4.00
1 YEAR \$2.50

REGULAR RATES

3 YEARS \$8.00
2 YEARS \$6.00
1 YEAR \$3.50

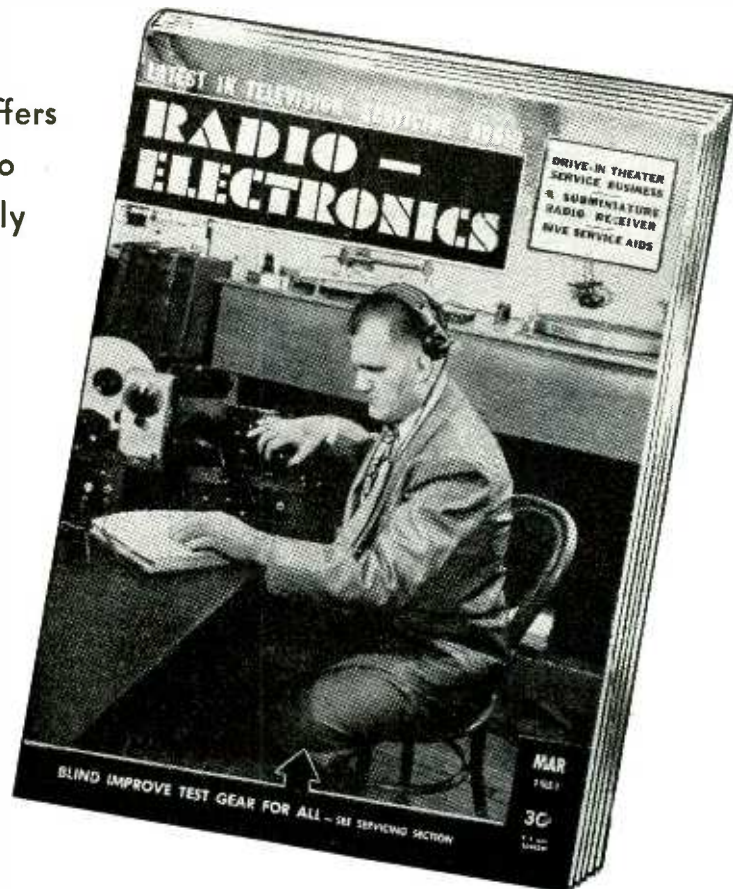

RADIO TELEVISION AUDIO

• Servicing • Installation • Construction • New Developments

This special offer saves you up to \$2.50 over the regular subscription rates and up to 15¢ a copy over the newsstand price. Get the best technical articles on radio, television and audio every month, subscribe to RADIO-ELECTRONICS now for an extended period at these money saving rates. But act now—this offer is made for a limited time!

**RADIO -
ELECTRONICS**

25 West Broadway

APRIL, 1951

New York 7, N. Y.

Peak

the Picture Power
with an
INLINE* ANTENNA



The right antenna will improve
the picture quality of any TV set

Specify
**AMPHENOL
-INLINE*
TV ANTENNA**

The Amphenol Inline Antenna has a single forward lobe. This means it intercepts peak signal power from one direction. Numerous minor lobes, which are absent from the Amphenol Inline Antenna, frequently pick up reflected signal causing "ghosts" and poor picture quality. Everyone judges the performance of his set by the picture on the screen. However, it is the receiver plus the antenna that creates the picture. To get the most from any set specify Amphenol Inline Antenna!

*REISSUE PAT. NO. 23,273



AMERICAN PHENOLIC CORPORATION
1830 SOUTH 54TH AVENUE • CHICAGO 50, ILLINOIS

DYNAMIC MICROPHONE

The Turner Co.
Cedar Rapids, Iowa

The 50D Aristocrat is a new dynamic microphone having response flat within ± 2.5 db from 50 to 15,000 cycles. It is omnidirectional and is available with



15-, 200-, 500-ohm, and high-impedance outputs. Its sensitivity is 56 db below 1 volt/dyne/sq. cm.

A swivel-type mounting permits it to be tipped in any direction when mounted on a stand or boom. The 50D can be taken off the stand for hand use.

VEHICULAR CAPACITORS

Cornell-Dubilier Electric Corp.
South Plainfield, N. J.

These bypass and feed-through capacitors are hermetically sealed and built to withstand extremes of vibration



and shock and for operation over temperature range from -55°C . to $+85^{\circ}\text{C}$. Non-inductive winding with short connections results in low impedance over wide frequency range.

The MC series is provided with three bracket styles. The NF 10072 has a universal mounting bracket. All have terminal studs with fastener screws. The MC series is designed for bypass applications; the NF series is designed for feed-through.

TELEVISION BOOSTER

Standard Coil Products Co., Inc.
Chicago, Ill.

The model 8-51 is a new and improved printed-circuit TV booster which

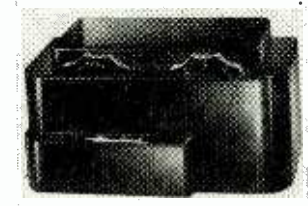

provides continuous one-knob tuning between channels without switching between the high and low TV bands. It is a one-stage preamplifier which provides a low noise factor and high gain on all channels.

PHONO CARTRIDGES

The Astatic Corp.
Conneaut, Ohio

The new AC series phonograph cartridges are available with ceramic or crystal elements in both double-needle turnover and single-needle models. Physical characteristics and minimum needle pressure (approximately 5

grams) is the same for all models.

Audio output of crystal models at 1 kc is 1 volt using Audiotone 78-1 and RCA 12-5-31V test records; and the output of ceramic units is 0.4 volt. Frequency range of single-needle crystal units with either 3-mil needle for 78-r.p.m. or All-Groove needle for all record types is 50 to 10,000 cycles and for double-needle types frequency range is 50 to 6,000 cycles. Single-needle ceramics have a range of 50 to 6,000 cycles and double-needle ceramics have a range of 50 to 5,000 cycles.

The CAC type crystal cartridge is now expanded into a series of models which includes the original CAC-J, CAC-78-J (a similar unit having a 3-mil sapphire stylus for 78-r.p.m. records), and models CAC-W-J (1-mil needle) and CAC-78W-J (3-mil needle)

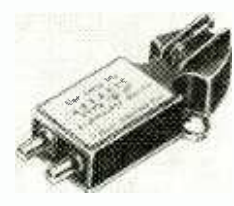

furnished with special fittings for installation in record changers having plug-in heads. The CAC-J is internally equalized for Columbia LP's.

ALL-WAVE RECEIVER

National Co., Inc.
Malden, Mass.

The model SW-54 is a compact 5-tube a.c.-d.c. superheterodyne receiver for AM or c.w. reception between 540 kc. and 30 mc. It features a slide-rule tuning dial with police, amateur, foreign, and marine bands plainly marked; a novel bandspread dial, built-in speaker, and a cabinet which measures only 11 x 7 x 7 inches. In addition to the tuning and volume controls, the SW-54 has send-receive, AM-c.w., and speaker-phones switches on the front panel. The tube lineup consists of a

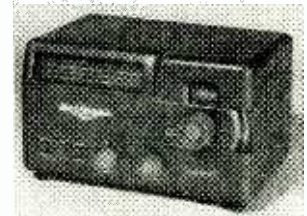

12BE6 converter, 12BA6 i.f. amplifier and b.f.o., 12AV6 second detector, first audio, and a.v.c., 50C5 audio output, and 35Z5 rectifier.

MIXER-PREAMPLIFIER

Rauland-Borg Corp.
Chicago, Ill.

This new completely self-contained remote mixer and preamplifier is designed to mix four inputs (high- or low-impedance mikes and crystal pickups) and to feed the program over remote lines to main amplifying equipment located at any required distance away (up to several miles, if desired).

Specifications—Distortion: (measured at 100, 400 and 5,000 cycles, 300 mw, 2% at 600 ohms). Gain: microphones—109 db (2 meg), 96 db (100,000 ohms), 96 db (150 ohm input); phono—73 db (1/2 meg input). Master control, 15 db. Frequency response: ± 1 db, 40 to 20,000 cycles. Output impedance, 150/600 ohms. Hum and noise level: 47 db below rated output (unweighted) on mike, 60 db below rated power output (unweighted) on phono. Tubes: 4-6SQ7, 2-6SC7, 2-6SN7GTA, 1-6XGT.



RADIO-ELECTRONICS for

WIDE-RANGE OSCILLATOR

General Radio Co.
Cambridge, Mass.

The type 1330-A bridge-type oscillator is designed for use in antenna and bridge measurements. Its tuning range

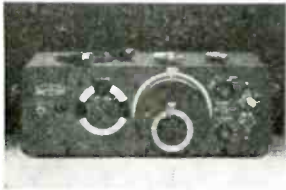

is continuous from 5 kc to 50 mc with two levels of internal modulation at 400 and 1,000 cycles. Output is approximately 1 volt, and more than 1 watt can be delivered into a 50-ohm load.

The 1330-A is 11 pounds lighter, requires about one-half the input power, delivers 10 times the output power at a lower impedance, and covers a wider frequency range than its pre-war equivalent.

HIGH-VOLTAGE SUPPLY

Spellman Television Corp.
New York, N. Y.

A new r.f.-type high-voltage supply is available for laboratory and industrial use. Designed for 4,500 volts d.c., the unit will deliver up to 7,500 volts at 1 ma. The supply is housed in a 5 7/8 x 4 1/2 x 5-inch case, and is available with either positive or negative outputs.

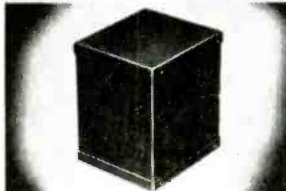
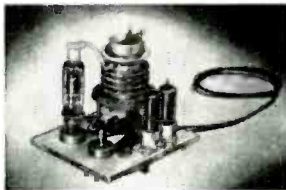
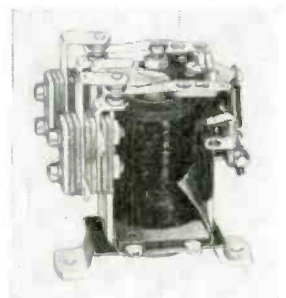

PLATE CIRCUIT RELAYS

Potter & Brumfield
Princeton, Indiana

LM Series relays are of the long coil-type construction, giving a powerful magnetic circuit that with 10,000-ohm winding permits adjustment to pull in as low as 1 ma with contact pressure sufficient to carry 5 amperes. The nominal operating power is 0.1 watt. The design includes an adjustable arma-



ture return spring which allows easy adjustment when installing to meet unusual or variable current or voltage conditions. The armature is equipped with an adjustable residual screw which controls the ratio between pull-in and drop-out current. LM relays are stocked in 2,500-, 5,000-, and 10,000-ohm windings and all contact combinations up to double-pole double-throw.

The new LS series relays are smaller and adjustments are preset at the factory to maximum sensitivity and lowest differential. They are available in s.p. d.t. only with contacts for 5 amperes and windings of 2,500 and 5,000 ohms.

CIRCLE CUTTER

Precise Co.
Brooklyn, N. Y.

The new Micro circle cutters feature a micrometer-type size control for quick, exact settings, extra-rigid beam construction for quicker cutting, and a new type of beam lock mechanism. Model 1 cuts holes from 1 to 4 inches in diameter and is available with either round or square tapered shanks. The model 5 cuts holes up to 6 inches.

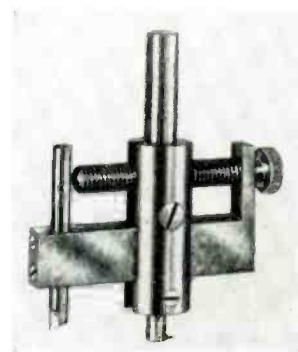

TV TUBE COATING

General Cement Mfg. Co.
Rockford, Ill.

Tube Coat is a new fast-drying conductive material designed for recoating the outside of television picture tubes which are peeling or have been scratched during repair. It is also useful for coating the inside of TV cabinets to prevent high-voltage discharges.

MASK FOR TV TUBE

Allen B. Du Mont Laboratories, Inc.
Clifton, N. J.

The new mask makes it easy to replace 12JP4 and 12RP4 picture tubes with a 12QP4-A in early Du Mont Telesets and most receivers of other makes. The mask compensates for greater radius of face curvature in the 12QP4-A. The 12QP4-A is a popular replacement for these tubes because of its close similarity to the older types and its gray filter face plate.

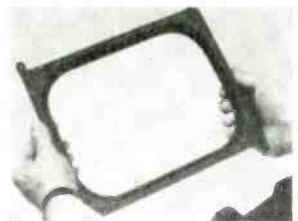

REPLACEMENT CONTROLS

Clarostat Mfg. Co., Inc.
Dover, N. H.

The new Ad-A-Switch replacement controls make it easy to install a switch when needed. Formerly controls were fitted with a separate dust cover which was fastened to the body of the control by lugs. The new design features a metal casing with scored center section and tab which can be pried open and torn off to provide an opening for the proper Ad-A-Switch. Two lugs on the switch pass through side strips on the case and are slightly bent to hold the switch firmly in place.

Six types of switches are available along with twelve different shafts which make it possible to duplicate almost any type of variable-resistance control.

MAGNETIC AMPLIFIERS

Magnetic Amplifiers, Inc.
Long Island City, N. Y.

A new line of magnetic amplifiers for 60 and 400 cycles, saturable reactors, special transformers, and other related devices for use in computers, regulators, servomechanisms, and recorders is announced by Magnetic Amplifiers, Inc. Their engineering staff will design special and custom-built units.

— END —

BUILD 15 RADIOS AT HOME

With the New Improved 1951 Progressive Radio "EDU-KIT"

ONLY \$19.95



- FREE TOOLS WITH KIT
- ABSOLUTELY NO KNOWLEDGE OF RADIO NECESSARY
- NO ADDITIONAL PARTS NEEDED
- EXCELLENT BACKGROUND FOR TELEVISION
- 10 DAY MONEY-BACK GUARANTEE

WHAT THE PROGRESSIVE RADIO "EDU-KIT" OFFERS YOU

The Progressive Radio "Edu-Kit" offers you a home study course at a rock bottom price. Our Kit is designed to train Radio Technicians, with the basic facts of Radio Theory and Construction Practice expressed simply and clearly. You will gain a knowledge of basic Radio Principles involved in Radio Reception, Radio Transmission and Audio Amplification.

You will learn how to identify Radio Symbols and Diagrams; how to build radios, using regular radio circuit schematics; how to mount various radio parts; how to wire and solder in a professional manner. You will learn how to operate Receivers, Transmitters, and Audio Amplifiers. You will learn how to service and trouble-shoot radios. In brief, you will receive a basic education in Radio exactly like the kind you would expect to receive in a Radio Course costing several hundreds of dollars.

THE KIT FOR EVERYONE

The Progressive Radio "Edu-Kit" was specifically prepared for any person who has a desire to learn Radio. The Kit has been used successfully by young and old in all parts of the world. It is not necessary that you have even the slightest background in science or radio.

The Progressive Radio "Edu-Kit" is used by many Radio Schools and Clubs in this country and abroad. It is used by the Veterans Administration for Vocational Guidance and Training.

The Progressive Radio "Edu-Kit" requires no instructor. All instructions are included. All parts are individually boxed, and identified by name, photograph and diagram. Every step involved in building these sets is carefully explained. You cannot make a mistake.

PROGRESSIVE TEACHING METHOD

The Progressive Radio "Edu-Kit" comes complete with instructions. These instructions are arranged in a clear, simple and progressive manner. The theory of Radio Transmission, Radio Reception and Audio Amplification is clearly explained. Every part is identified by photograph and diagram; you will learn the function and theory of every part used.

The Progressive Radio "Edu-Kit" uses the principle of "Learn By Doing". Therefore you will build radios to illustrate the principles which you learn. These radios are designed in a modern manner, according to the best principles of present-day educational practice. You begin by building a simple radio. The next set that you build is slightly more advanced. Gradually, in a progressive manner, you will find yourself constructing still more advanced radio sets, and doing work like a professional Radio Technician. Altogether you will build fifteen radios, including Receivers, Amplifiers and Transmitters.

The Progressive Radio "EDU-KIT" Is Complete

You will receive every part necessary to build 15 different radio sets. This includes tubes, tube sockets, variable condensers, electrolytic condensers, mica condensers, paper condensers, resistors, tie strips, coils, tubing, hardware, etc. Every part that you need is included. In addition these parts are invariably packaged, so that you can easily identify every item.

TROUBLE-SHOOTING LESSONS

Trouble-shooting and servicing lessons are included. You will be taught to recognize and repair troubles. While you are learning in this practical way, you will be able to do many a repair job for your neighbors and friends, and charge fees which will far exceed the cost of the Kit. Here is an opportunity for you to learn radio and have others pay for it.

FREE EXTRAS IN 1951

- ELECTRICAL AND RADIO TESTER
- ELECTRIC SOLDERING IRON
- BOOK ON TELEVISION
- RADIO TROUBLE-SHOOTING GUIDE
- MEMBERSHIP IN RADIO-TELEVISION CLUB
- CONSULTATION SERVICE • QUIZZES

The Progressive Radio "Edu-Kit" is sold with a 10-day money-back guarantee. Order your Progressive Radio "EDU-KIT" Today, or send for further information.

Postage prepaid on cash orders—C.O.D. orders accepted in U. S. A.

PROGRESSIVE ELECTRONICS CO.
497 UNION AVE., Dept. RE-46 Brooklyn 11, N. Y.

→ TUBES

EVERY CRITICAL TYPE

TERRIFIC DISCOUNTS

ALL MERCHANDISE FULLY GUARANTEED

IMMEDIATE SHIPMENT

WE CARRY TREMENDOUS STOCKS OF HARD-TO-GET TUBES. WRITE, WIRE OR PHONE US YOUR REQUIREMENTS. MAKE THIS YOUR HEADQUARTERS FOR CRITICAL TYPE TUBES.



TV PICTURE TUBES

G. E. and HYTRON in stock for immediate delivery

7JP4	\$18.37	16KP4A	\$43.12
10 FP4A	28.91	17BP4A	38.56
12LP4A	25.63	19AP4A	61.20
16KP4	39.79	20CP4	64.92

All prices net. (In California add 3% Sales Tax)
Full Factory Guarantee.
FREE with each purchase:
G.E. Picture Tube Replacement Guide.
G.E. Sweep Circuit Book.

Terms: 25% with order. Balance C.O.D. Send remittance in full and save C.O.D. charges.

COAST ELECTRONIC SUPPLY COMPANY
527 W. Main Street
Alhambra, California Phone: ATlantic 9-4361

BECOME A RADIO AMATEUR

Complete Home Study Course for passing FCC Amateur Radio Examinations.

LOW COST • PERSONAL COACHING
Write for details

FEDERAL ELECTRONICS INSTITUTE
45 East Putnam Avenue (Dept. F)
Greenwich, Conn.

ON-THE SPOT BATTERY RECORDER

WALKIE-RECORDALL 8 lb. miniature **BATTERY RECORDER-PLAYBACK**

Continuous, permanent, accurate, indexed recording at only 5¢ per hr. Instantaneous, permanent playback. Picks up sound up to 60 ft. Records conferences, lectures, dictation, 2-way phone & sales talks; while walking, riding or flying. Records in closed briefcase with "hidden mike"! Write for details.

MILES REPRODUCER CO., INC.

812 BROADWAY Dep't RE4 NEW YORK 3, N. Y.

SILVER SOLDER TORCH & KIT \$6

Joins All Metals Permanently
Equal to Welding for Most Purposes



Do your own repairing. KIT includes one tube silver solder flux and 10 5-in. lengths silver solder alloy. Hottest ALCOHOL TORCH known. 2700° F. flame. Operates in any position, indoors or out. Torch alone \$5. Kit alone \$1.50. Complete instructions included with torch and kit. Add 25¢ on each order towards shipping charges.

AMERICAN PRODUCTS CORPORATION DEPT 11-D
422 S. Dearborn St. Chicago 5, Illinois

WANTED

- PE-237 POWER SUPPLY
- GN-58 GENERATOR
- 1306 TRANSMITTER RECEIVER

BEST PRICES—NO QUANTITY TOO BIG, NONE TOO SMALL.

WRITE TODAY GIVING DETAILS TO — Box P-51-4, c/o Radio-Electronics, 25 W. Broadway, N. Y. C.

COLOR TONE ON YOUR TELEVISION!



Simply attach TELECOLOR FILTER to front of set and enjoy favorite programs in wonderful glorious color tones instead of dull black and white. TELECOLOR FILTER is one of the latest discoveries. Its special formula coloring gives brilliant, pleasing, genuine color tone, life like color depth, reduced eyestrain and glare. See our January ad—page 114—Free Information! Write Dept. RE-4

HARVARD LABORATORY • 659 FULTON STREET • BROOKLYN 1, N. Y.

ORDER BY MAIL

10 inch	\$3.00
12 or 14 inch	4.00
16 or 17 inch	6.00
19 or 21 inch	10.00

→ ARE TUBES YOUR PROBLEM?

Draw from one of the largest inventories in the East

RADIO — TELEVISION — TRANSMITTING

Write or Phone → **Louis H. Grossberg**

SEND FOR pamphlet of 1,000,000 non-critical receiving tubes—excellent as substitutes—up to 90% off list.

SOLO ELECTRONIC SALES CORP.
190 Washington Street, New York 7, N. Y.



Your editor has been pleased to note that your activities in assisting to boost the Help-Freddie-Walk Fund again showed gratifying results this month. The fund now has reached \$7,253.71.

As most of our readers know by this time, Freddie Thomson is the young son of the Arkansas radio technician, who was born both armless and legless. Freddie reaches his third birthday on March 31 and he continues to make excellent progress with his new legs. As this is written Freddie has come up North again to the Kessler Institute for Rehabilitation at West Orange, New Jersey, accompanied by his father, where he undergoes periodic fittings.

Up to now he has been too young for the fitting of artificial arms. He also has to be taught certain exercises and because he has not even leg or arm stumps but only a trunk and a head, the only way he can walk is by twisting his body from side to side.

Up to now he has not accomplished walking. He can only balance himself. Several times a year he has to come North for the fitting of new appliances which is both costly and time consuming and for these reasons for a long time to come additional funds for Freddie must be collected.

As it has been from the start the purpose of this magazine, in connection with Freddie's activities, to make Freddie a radio technician, we are sure in time he will be a good one.

This month we report club donations of the following:



Freddie is making encouraging progress. RADIO-ELECTRONICS for

\$60.00 contributed by the Electronic Technicians of the *USS Chevalier* DDR805, San Francisco, Calif.

\$115.40 collected by J. F. Mesearch, Division Officer, on behalf of the 89 men in the "Electrical Division" of the *USS Valley Forge* (Cv-45), San Francisco, Calif.

\$164.00 contributed by the Members of the 50th Signal Service Det., San Francisco, California.

\$35.00 tendered by M. Celesta Babiniau for the People in the Auditing Department of the Boston Branch of the John Hancock Insurance Co., Boston, Mass.

\$25.00 contributed by the Buckeye Chapter of "The Representatives", Cleveland, Ohio.

Please do not neglect your efforts to help make Freddie a worthwhile and efficient radio technician when he grows up. Please send in your contributions from time to time. Even the smallest donation will be highly welcome.

Make all checks, money orders, etc., payable to *Herschel Thomason*. Please address all letters to:

Help-Freddie-Walk Fund
c/o RADIO-ELECTRONICS
25 West Broadway
New York 7, N. Y.

Balance as of January 22, 1951	\$6,645.93
Alva Allen Chevrolet Company—Clinton, Mo.	\$10.00
Anonymous—Oakland, Calif.	1.00
Anonymous—Miami, Fla.	2.00
Anonymous—Chicago, Ill.	2.75
Anonymous—New Orleans, La.	10.00
Anonymous—Metuchen, N. J.	1.00
R. M. S. Associates, Inc.—Mamaronck, N. Y.	9.00
Kenneth Bable—Burgettstown, Pa.	5.00
Mr. & Mrs. N. A. Basso—Morgantown, W. Va.	2.13
S. B. Boynton—Chicago, Ill.	1.00
Mrs. George R. Burton—Penacook, N. H.	5.00
M. J. Candela—Chicago, Ill.	1.00
Joseph T. Corrigan—New York, N. Y.	5.00
L. P. Croak—Chicago, Ill.	1.00
Joel Decker—Washington, Pa.	1.00
Lee de Forest—Hollywood, Calif.	50.00
C. Del Priore—Cliffwood, N. J.	1.00
C. De Silva—Pamankade, Dehiwala, Ceylon.	2.50
Members of the 50th Signal Service Det.—San Francisco, Calif.	164.00
Van H. Ferguson—Tallahassee, Fla.	5.00
Gesundheit—Trainer, Pa.	1.00
Sam J. Graffia, Graffia's Radio Service—Maringouin, La.	1.00
Amedee Grenier—London, Ont., Canada	1.00
Halverson Radio Service—Bagley, Minn.	2.50
Auditing Department of the Boston Branch of the John Hancock Life Insurance Company—Boston, Mass.	35.00
Elias Hauer—Caracas, Venezuela, So. Amer.	10.00
Irv's Radio Service—Niagara Falls, N. Y.	1.00
L. Jaffee—Chicago, Ill.	1.00
Verne N. Johnson—Los Angeles, Calif.	1.00
Arthur Johnston—Johnstown, Pa.	2.00
Erma Kessler—Maplewood, Mo.	5.00
Lakewood Liquor Store—Lakewood, N. Y.	2.00
Jack Lee—Somerville, Mass.	1.00
F. Levin—Chicago, Ill.	.50
Matthews Radio Repair Service—Bradford, Pa.	2.00
D. O'Neil—Chicago, Ill.	1.00
Rev. Joseph F. O'Reilly—Collinsville, Ill.	5.00
R. G. Pease—Chicago, Ill.	1.00
C. E. Peters—Lincoln, Nebr.	2.00
B. Platosh—Chicago, Ill.	1.00
Helen & Harold Reiner—Bronx, N. Y.	5.00
Buckeye Chapter of "The Representatives"—Cleveland, Ohio	25.00
S. J. S.—New York, N.Y.	10.00
H. Schneider—Chicago, Ill.	1.00
S. Schneider—Chicago, Ill.	1.00
A. Serna—Dearborn, Mich.	1.00
E. G. Shorey—Chicago, Ill.	1.00
Some Magazine Friends—Ordell, N. J.	1.00
Sonia & Joe—Ancon, Canal Zone	2.00
Sammy J. Spradlin—Ashland, Ky.	5.00
Electronic Technicians of the <i>USS CHEVALIER</i> , DDR805—San Francisco, Calif.	60.00
89 Men in the "Electrical Division" of the <i>USS VALLEY FORGE</i> (CV-45)—San Francisco, Calif.	115.40
Vanson Products Lab.—Akron, O.	5.00
Kenny Wiewara—Los Cruces, N. M.	3.00
Lt. Com. William Coulter Walsh, Jr., USN—Watertown, S. Dak.	5.00
Edward G. Winters—Allentown, Pa.	10.00
Total Contributions received to February 20, 1951	\$7,253.71

NIAGARA is "HOLDING the LINE" on PRICES!

ONE OF AMERICA'S GREAT ELECTRONICS STORES

10 MILES WITHOUT BATTERIES! RCA SOUND POWER PHONES

RCA No. M1-2475 Navy Type "O". You can actually hold two-way conversations over wired circuits up to TEN MILES with these Sound Power phones. Any number of these units may be paralleled on same line without loss of power. Ample volume—excellent tone quality—rubber cushioned earphones, mouthpiece microphone attached. Massive construction, multiple adjustments, 22-ft. rubber cord, push-to-talk switch, navy waterproof plug. Ideal for TV antenna installations, field tests, hunting, mining, games, etc. Cat. No. N-300. Your inst. each unit, comprising 1 pair headphones, microphone, cord and plug, as illustrated \$9.95. Same as above with mike on chest plate. Type "O" RCA M1-2454B \$4.95



TUBES

NEW—BRANDED—GUARANTEED
LARGE STOCK
RECEIVING—TRANSMITTING
INDUSTRIAL
LOW PRICES
Quotation on Request

NEW SHIPMENT ARC-5/R-28 (Plus \$2.50 BONUS)* Hottest 2-Meter Receiver Ever Built!

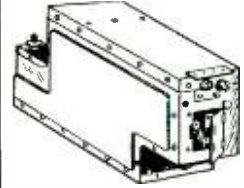

Here is the 2-meter superhet you have been looking for! Absolutely the BEST available today! Tunes from 100 to 156 Mcs. in four crystal channels. (Easily converted to continuous tuning.) Tube lineup is as follows:

717A—R.F., 717A—Mixer, 2-12SH7—1st and 2nd I.F. (6.9 Mc.) 12SL7—Det-AVC-Squelch, 12SL7—1st audio-squelch amplifier, 12A6—2nd audio, 12SH7—R.F. Osc.—4th Harmonic Gen., 717A—Trip, 12th Harmonic Gen., 717A—Dblr.—12th harmonic gen. A highly desirable superhet, made of rigidly inspected parts and contained in a louvered aluminum cabinet measuring 7 3/8" x 4 3/8" x 14". Complete with all tubes in original sealed cartons \$29.95

***FOR A LIMITED TIME ONLY!**
with each order for ARC-5 R-28 Receivers, one copy of Vol. 2 "Surplus Radio Conversion Manual" (Regular price \$2.50) will be shipped at no additional cost! This volume contains circuit diagram and full description of above receiver, plus a wealth of additional conversion data on many other popular items of surplus equipment. ACT NOW, for YOUR \$2.50 BONUS!

TRANSFORMER BARGAINS

511-T1	330-0-330 600MA	\$5.75
D-161913	2500V 4MA. (TV or Scope)	3.95
GE9126	612-593-0-593-612V 200MA.	9.95
T-2	2.5V 10A	\$4.95
528049	5 VCT-3A, 5 VCT-10.5A, 6.3 VCT-3.5V	4.50
475-T201	5 VCT-15A	5.95
P-4091	7.5 V-5A	2.49
D-161917	6.3 V-3A, 2.5V-2A	2.85
ARC-3	807 R.F. to PP 6L6 Mod.	\$2.49
A-3866	200.500 Ohms to 5, 6, 7, 8, 9, 10 K. ohms, 150 MA.	3.49
T-101	(ART 13) 813 R.F. to PP 211	7.95
900716	550 ohms "AB2" Rod. (P.P.) to 2600 ohms R.F. 150 W. R.F. (RCA) "AB" PP 807 to "C" 425V-240 Ma.	3.50
T-47171		
511-T2	350-0-350V-150MA., 6.3V-6A	\$2.15
466-T1R	110-0-110V-225MA., 5V-3A	1.95
PC-110	300-0-300V-125MA., 6.3V-3.8A, 5V-3A	2.95
P-6010	325-0-325V-40MA., 6.3 VCT-2A, 5V-3A	2.49
P-6001	325-0-325 40MA., 5 VCT-2A, 2.5 VCT-4A	2.25
P-6009	275-0-275 70MA., 5V-5A, 2.5V-10.5A	3.00
T-47165	135-0-135 90MA., 5V-3A, 5V-3A	2.49
A-4205	10,000 OHM Plate to Single Grid. P.P. 6L6, 2A3, etc., to P.P. Grids.	\$0.89
A-4404		1.65
SP-10	6V6 to 2, 4, 8 OHMS	\$0.69
SP-12	P.P. 6V6 to 8 OHMS	.75
T-46255	P.P. Par. 6N7 "B" to 8000 OHMS	1.49
511-T1	6V6 to 8 or 800 OHMS	.85
11666	6V6 to Voice Coil or 500 Ohm Line	1.89
T-47368	600 OHM C.T. to 300 OHM Mike	\$1.29
T-47369	30 OHM Mike to 600 OHM C.T. Sec.	\$1.65
L-143	1.72 HY	\$8.95
C-2303	2.5	1.10
475-CH301	3.8	1.25
32584	8	2.35
10634	10 180 Ohm Dual	3.49
2647	40 80 Ohm	2.49
2-RR2	10-60 .05-4 AMP5. (10 KV)	19.95

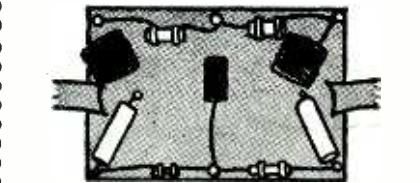

BANISH INTERFERENCE

with NIAGARA Famous HI-PASS FILTER

Positive protection against interference from amateur transmitters, diathermy, and all other devices generating radio frequency interference below 40 Mcs. Designed for 300-ohm lead-in. No loss in brightness of clarity. Wired and Tested. Postpaid if entire amount is included with order \$2.95

IMPORTANT NOTICE: Minimum Order \$5. Quantity prices on request. All items in stock now—subject to prior sale—prices subject to change without notice. 20% deposit with orders unless rated. All prices F.O.B. our N.Y.C. Warehouse.

Niagara Radio Supply Corp.

Dept. C-41 160 Greenwich Street, New York 6, N. Y.

Phone
Dlgbly 9.
1132-3-4

SOUNDTRONICS SPECIALS

SARKES TARZIAN
13 Channel T.V. Tuner
Same type used by leading Mfrs.—West, Magnavox, Teking, Meck, etc. Ideal for schools, mfrs., etc. Uses 6C4 Osc., 6AG5 Mixer, 6BH6 R.F. Amp.



Guaranteed
Less Tubes, with Shields & Diagram.

\$3.95

3 TUBE KIT FOR TUNER
6C4, 6AG5, 6BH6 **\$3.63**

NEW ARC 5 I.F. ONLY CHASSIS - - \$2.19

Comprises mixer, 2 IF's, 2nd. Detector, A.V.C., Squelch, & 2 Audio Stages. Shipping Wt. 5 lbs.

14 PIN TV SOCKETS for 3BP1, 7JP4, etc.
Black Bakelite15c Mica Filled 28c

F. P. ELECTROLYTIC SPECIAL
In 10-10-20 MFD 450-450-450-25 Volts
59c each 2 for \$1.10

TOP BRAND TUBULAR CONDENSERS
.1 MFD 1000 Working Volts..... 9c
.05 MFD 400 V..... 7c .25 MFD 400 V..... 7c
.035 MFD 600 V..... 6c .035 MFD 1000 V..... 8c

AEROGLAS #22 1250 V INSUL. WIRE
White with tracer
100' **\$1.19** 1000' **\$9.98**

MUTER CERAMIC CONDENSERS, 600 V.
15, 22, 33, 56, 75, 82, 180, 220 MMFD.
5c each **\$4.50 per C**

U.T.C. CHOKES P.A. CASES
10 HY @ 66 MA... **\$1.15** 10 HY @ 110 MA... **\$1.55**
5 HY @ 150 MA... **1.95** 10 HY @ 150 MA... **2.50**

SPECIAL ASSORTMENTS
50 new pop. type coded res. 50
small pop. ceramic cond., all
voltages & cop. 50 postage stamp
mica cond. } Your choice
\$1.49 each } asst.

6 V. 12 Amp Fil. TRANS. 115 V. @ 60 Imp. Open
frame, 2 1/2" x 3" x 3 1/2" **\$1.98**

SPRING SPECIAL
New Army Mine Detector AN/PRS-1. Will detect
metallic & non-metallic objects, buried cables,
etc. Uses 3-45 V. & 1-6 V. bat. Complete,
w/spare rods, tubes, etc. Less Batteries. **\$19.95**

RCA 930 PHOTO TUBE
Compl. w/diagram. For P.E. Control of doors, lights,
etc. **\$1.49**

VERT BLOCKING OSC. TRANSFORMERS
Same as used in 630 T.S. 89c ea.

Min. Order, \$5.00—25% w/order required

SOUNDTRONICS LABS.
632 Arch St., Phila. 6, Pa. MA 7-2775

AUTOMATIC M-90 AUTO RADIO



- Six Tube Superheterodyne • Three Gang Condenser • Powerful, Long-Distance Reception • Fits All Cars, Easy Installation
- Mounting Brackets Included
- 6 Tube model M90 ***\$33.87**
*Above price includes Federal license &
Approx. shipping weight (11) eleven pounds.

MAIL US YOUR ORDERS
All orders filled within 24 hours.
Standard Brand tubes 50% off list

Bill Sutton's Wholesale Electronics
Fifth at Commerce Fort Worth, Texas

Radio Thirty-Five Years Ago
In Gernsback Publications

HUGO GERNSBACK Founder	
Modern Electrics	1908
Electric Experimenter	1913
Radio News	1919
Science & Invention	1920
Television	1927
Radio-Craft	1929
Short-Wave Craft	1930
Television News	1931
Wireless Association of America	1908

Some of the larger libraries still have copies of **ELECTRICAL EXPERIMENTER** on file for interested readers.

**APRIL, 1951
ELECTRICAL EXPERIMENTER**

Motorcycle Wireless Telephone Output
Giant U. S. Radio Station at San Diego
Railroad May Operate Trains by Radio
California Youth Invents Radiotelephone System
An Efficient Battery-Type Radio Transmitter
The Early Days of Radio in America, by Donald H. McNicol, I.R.E.
A Practical Radiation Meter, by Otto Whitelock
A Selenium Cell Radiation Ammeter, by Frank Walcutt
Spring Clip Detector Stand, by Wilton M. Smith
Telefunken Type Permanent Detector by E. L. Kenney
Panel Wireless Key, by H. R. Hosbach
A Novel High-Frequency Ammeter, by C. A. Oldroyd
Double Capacity Rotary Variable Condenser, by G. Merton Bingham
A 4,000 Meter "Vest-Pocket" Radio Set, by Herbert E. Hayden

ELECTRONIC LITERATURE

Any or all of these catalogs, bulletins, and periodicals are available to you if you write to us on your letterhead (do not use postcards) and request them by number. Send coin or stamps where cash is required. We will forward the request to the manufacturers, who in turn will send the literature directly to you. This offer void after six months.

1-451—TRANSFORMER CATALOG
Triad Transformer Manufacturing Co. has released its latest transformer catalog (No. TR-51). It contains detailed specifications, illustrations, and prices on their regular line of audio and power transformers and chokes, and 35 new items which include a series of special transformers developed for regulated power supplies, television components, and a high-fidelity amplifier kit. The catalog also contains complete schematic diagrams of several audio amplifiers and a voltage-regulated power supply.—*Gratis*

2-451—PHONO ACCESSORY CATALOG
The new G-E phono accessories catalog is a compilation of technical data sheets on V-R cartridges, tone arms, preamplifiers, and styli.—*Gratis*

3-451—RECORDING EQUIPMENT
A 20-page illustrated brochure (Form 2J-6895) describes RCA's latest professional-type disc recording equipment and includes technical information on recording, fine-groove techniques, and studio recording techniques.—*Gratis to interested parties.*

OPPORTUNITY AD-LETS

Advertisements in this section cost 35¢ a word for each insertion. Name, address and initials must be included at the above rate. Cash should accompany all classified advertisements unless placed by an accredited advertising agency. No advertisement for less than ten words accepted. Ten percent discount six issues; twenty percent for twelve issues. Objectionable or misleading advertisements not accepted. Advertisements for June issue must reach us not later than April 21, 1951.
Radio-Electronics, 25 W. Broadway, New York 7, N. Y.

NEED SIX 1-222A in good condition. Will take all or part. Advise price. Box OA-4, c/o Radio Electronics, 25 West Broadway, New York 7, N. Y.

SPEAKERS REPAIRED at wholesale prices. Guaranteed workmanship. Jobbers wanted. Amprite Speaker Service, 70 Vesey St., New York 7, N. Y.

RADIO—TELEVISION—APPLIANCES. Sales \$350,000 year; large Ohio Industrial City; complete sales, service departments; sound equipment; five trucks; priced reasonable. **APPLE COMPANY BROKERS, 1836 Euclid Ave., Cleveland, Ohio.**

TWO #102 JEFFERSON-TRAVIS 10-watt Radio Telephones in original crates. Operates on 6 or 12 Volts DC. Best cash offer f.o.b. Altunor Manufacturing Company, Inc., Knoxville, Tennessee.

RHOMBIC TV ANTENNAS—BUILD YOUR OWN power—gains up to 100 for extreme fringe area reception. Drawings, complete instructions for 24 sizes \$1.50. Richard Buchan WITJE, Bricelyn, Minn.

MAGAZINES (BACK DATED)—FOREIGN, DOMESTIC Arts, books, booklets, subscriptions, pin-ups, etc. Catalog 10¢ (refund). Cleerose's, 86-22 Northern Blvd., Jackson Heights, N. Y.

WANTED—WORKING GRUNOW MODEL 11A-B-C Chassis reasonable. Collinsworth, WLAG, La Grange, Ga.

WE REPAIR, EXCHANGE, SELL ALL TYPES of electrical instruments, tube checkers and analyzers. Hazleton Instrument Co. (Electric Meter Laboratory), 140 Liberty Street, New York, N. Y. Telephone—BRaclar 7-4239.

LANCASTER, ALLWINE & ROMANEL, 436 BOWEN Building, Washington, D.C. Registered Patent Attorneys. Practice before United States Patent Office. Validity and infringement investigations and opinions. Booklet and form "Evidence of Concealment" forwarded upon request.

WANTED: AN/APR-4 other "APR", "ARR", "TS", "TB", "ARC-1", "ARC-3", "ART-13", everything Surplus. Spectal tubes, Tech Manuals, Lab quality Test Equipment, etc. Describe, price in first letter. Littell, Fairhills Box 26, Dayton 9, Ohio.

RADIO—TELEVISION—ELECTRONICS—TUTORING \$5 per lesson—Mo. Tech., 3907 North 25th Street, St. Louis 7, Missouri.

PHONOGRAPH RECORDS CHEAP. Catalogue. Paramount, FF-313 East Market, Wilkes-Barre, Penna.

SNIPERSCOPIES & SNOOPERSCOPIES WANTED. Any type, any condition. Needed immediately. Precision Company, 942 Kings Highway, Brooklyn 23, New York.

LOWEST PRICES. TUBES, PARTS, FREE LIST. Sandusky Radio, 2817 Harvard Ave., Cleveland, Ohio.

TUBES . . . HARD TO GET? SEND WANT LIST for quotations. Standard brands only. Quantity discounts available. TELRADCO, Box 108, Elizabeth, N. J.

LET US PUT THIS Magnificent NEW 1951 MIDWEST TELEVISION -RADIO-PHONO CONSOLE
in Your Home on 30 DAYS MONEY BACK TRIAL

FACTORY TO YOU **EASY TERMS**

MAMMOTH 19 1/2-Inch PICTURE
AM-FM Radio and 3-Speed Phonograph

Be your own judge! See and hear Midwest Television in your own home. Then decide whether to keep it or have your money refunded. Low Factory Prices.

Also Available on 30 DAYS TRIAL!
The Sensational New 5-Band World-ranging 1951 Model **MIDWEST RADIOS**

SEND THIS COUPON IN 1c POST CARD FOR NEW 1951 FREE & COLOR MIDWEST CATALOG

MIDWEST RADIO & TELEVISION CORP.
Dept. 38-L, 909 Broadway, Cincinnati 2, Ohio

NAME _____
ADDRESS _____
CITY _____ ZONE _____ STATE _____

4-451—SWEEP GENERATOR BULLETIN

An 8-page brochure issued by Manufacturers Engineering & Equipment Corp. gives complete electrical and mechanical specifications and general information on the Sweepmaster I video sweep generator. This unit is designed for checking the response of video and other broad-band amplifiers and for similar applications.—*Gratis*

5-451—SUN RADIO CATALOG

Containing 131 pages, Sun Radio & Electronics Co.'s catalog No. 51 lists test equipment, tubes, components, tools, and appliances produced by the major manufacturers. It will prove useful to engineers, constructors amateurs, and experimenters.—*Gratis*

6-451—RECTIFIER HANDBOOK

Selenium Rectifier Handbook is a 64-page booklet devoted to selenium rectifiers and their uses. In addition to complete electrical and mechanical specifications on the Sarkes Tarzian line of high- and low-voltage selenium rectifiers, the booklet contains 21 pages of typical circuits and applications.—*Price 25¢*

7-451—RCA TUBE BULLETIN

Form No. CRPS-120-A is RCA's latest bulletin on phototubes, cathode-ray and special tubes. It contains photographs, base diagrams, and electrical specifications on photomultipliers, gas and vacuum phototubes, monoscopes, C-R tubes for oscilloscopes, and special types for industrial and u.h.f. applications.—*Price 15¢*

8-451—TV CONTROL GUIDE

Centralab's TV control guide No. 12 lists their replacement controls and printed-circuit units used in television receivers. The TV sets are listed in alphabetical order according to manufacturer and in numerical order according to model or chassis number. Listed in the tables are the functions of each control and the manufacturer's part number along with the Centralab stock number for the control and special shafts and switches where necessary. Separate tables list the set manufacturer's part number, the component identification number, and corresponding catalog numbers of various printed-circuit components.—*Price 25¢*

9-451—RADIO-SOUND CATALOG

Hudson Radio & Television Corp. has issued its 1951 catalog No. H-51 which contains complete descriptions of standard brands of components required to assemble high-fidelity sound systems for home or professional use. It includes amplifiers, loudspeaker systems, enclosures, record changers, turntables, tuners, cabinets, and TV chassis. Also included are packaged systems which include tuner, record changer, amplifier, and speaker ready to be installed in walls or custom-built cabinets.—*Gratis*

10-451—TAPE RECORDER CATALOG

Amplifier Corp. of America's 1951 catalog lists the line of Twin-Trax and Magnetwin tape recorders plus a variety of microphones, erasers, and other accessories for tape recorders.—*Gratis*

— END —

HOTTEST TV PACKAGE for "ONE BUCK"!
FIRST EDITION SOLD OUT IN A FEW DAYS! PLENTY NOW AVAILABLE



- Hints for Better Pictures on 630TV
- 630TV Diagram with Modifications
- Illustrated TV Conversion Manual
- Pulse Keyed AGC Circuit Diagram
- RMA Resistor & Mica Code Charts

\$1.00

ALL FOR ONLY POSTPAID

EVERYONE INTERESTED IN TELEVISION should own this TV literature package... The information will be found useful on any make TV set. It's different and right to the point! It carries instructions that are up to the minute and not yet found in expensive text books. Indispensable to the TV technician yet easy enough for anyone with even a limited knowledge of TV to understand and follow. YOU HAVE NOTHING TO LOSE, YOUR MONEY WILL BE CHEERFULLY REFUNDED IF NOT COMPLETELY SATISFIED.

Just think of being able to convert any 10" TV set into a life-size 20" receiver in as little as one hour... The ILLUSTRATED TV CONVERSION MANUAL makes that possible.

SAVE MONEY ON REPAIRS—Important common occurrences are carefully analyzed and corrective procedures are suggested. You are told what to do—WHEN THE RECEIVER FAILS TO OPERATE, WHEN THERE ARE GHOSTS, INTERFERENCE, NO PICTURE, PICTURE FOLD-OVER, NO RASTER, PICTURE BLOOMS, DISTORTED PICTURE, PICTURE ROLLS, NO SOUND, DISTORTED SOUND, CORONA EFFECTS, ETC. PICTURE TUBE ASSEMBLY and PATTERN ADJUSTMENTS are outlined in detail (the ion trap adjustment caution may save you the price of a new picture tube). The HORIZONTAL SYNC, RCA TUNER and STANDARD TUNER step by step adjustments alone are worth many times the cost of this package.

TUNING GUIDANCE and ANTENNA ADVICE will enable you to enjoy peak performance at its best. The HIGH VOLTAGE CAUTION will give you that free and easy feeling of safety while handling the chassis or any of its parts.

The #630 CIRCUIT DIAGRAM, KEYED AGC DIAGRAM, RESISTOR & MICA CODE CHARTS need no emphasis as to their usefulness.

You will also receive our latest catalog and flyer with hundreds of special offers in Television, Chassis, Cabinets, Picture Tubes, Parts, Radios, Portables, Auto Radios, Radio Tubes, Test Equipment, Accessories, Etc., at WHOLESALE PRICES.

USE HANDY COUPON

BROOKS RADIO & TELEVISION CORP.
84 Vesey St., New York 7, N. Y.

Send complete package of TV literature

Enclosed find \$1.00 Cash Check M.O.

10% Discount on 6 or more packages

Send complete packages \$
Less 10% Discount \$
Net Amount Enclosed \$

NAME

ADDRESS

CITY STATE

EVERY RADIOMAN Can Use These SERVICE HINTS!

Valuable Manual Yours—FREE!

Every page of "How to Simplify Radio Repairs" is packed with on-the-bench, practical ideas... Contains photos, charts, diagrams—no fluff—no vague theory. In plain every-day language it gives you priceless suggestions—new servicing ideas. You'll use and benefit from the experience of experts. Partial list of contents: How to Localize Trouble; How to Service Amplifiers; How to Test for Distortion; How to Test Audio Circuits; How to Test Speakers; How to Find Faults in Oscillators; How to Test Radio Parts—and it's all yours—FREE! No obligation.

FEILER SEND COUPON OR PENNY POSTCARD FOR YOUR FREE COPY TODAY!

FEILER ENGINEERING CO., Dept. 4RC1
1601 S. Federal St., Chicago 16, Illinois
Please RUSH my FREE copy of "How to Simplify Radio Repairs."

Name

Address

City..... Zone... State.....

ALMO SPOTLIGHT SPECIAL

FOLDED DIPOLE TV KIT

- All channels
- Hi-Tensil 3/8" Aluminum Alloy elements
- Hi-and Lo-band arrays
- Complete with 2 mating 1 1/4" zinc plated lock-seam steel mast sections, 7 feet erected; 60' 300 OHM Twix-X lead-in cable; 35' guy wire; 2 mast stand-off insulators; 4 wall stand-off insulators; 3 screw eyes; guy ring

\$8.95

Complete Kit individually boxed... Weight 9 lbs.

10% Cash With Orders

ALMO RADIO CO.
509 ARCH STREET • Philadelphia
6205 MARKET STREET • West Phila.
6th & ORANGE STS. • Wilmington
4401 VENTNOR AVE. • Atlantic City

 * YOU CAN STILL *
 * Buy— *
 * **TROUBLEPROOF** *
 * **TELEVISION** *
 * **THE 630 TV WILL WORK** *
 * **WHERE OTHERS FAIL!** *

Own the Television Set preferred by more Radio and Television Engineers than any other TV set ever made!

THE ADVANCED CLASSIC 630 TV CHASSIS.
 * With the latest 1951 improvements the 630 TV will out-perform all other makes in every way. The new, high efficiency, 30 plus tube circuit should not be compared to the cheaply designed 24 tube sets now being sold under standard brand names.

- * **Greater Brilliance**
 Assured by the new 14-16 KV power supply.
 - * **Flicker-Free Reception**
 Assured by the new Keyed AGC circuit—no fading or tearing of the picture due to airplanes, noise, or other interference.
 - * **Greater Sensitivity**
 Assured by the new Standard Tuner, which has a pentode RF amplifier and acts like a built-in High Gain Television Booster on all channels! The advanced 630 chassis will operate where most other sets fail, giving good performance in fringe areas, and in noisy or weak locations.
 - * **Larger—Clearer Pictures—for 16", 17", 19" or 20" tubes**
 Assured by advanced circuits. Sufficient drive is available to easily accommodate any tube.
 - * **Trouble-Free Performance**
 Assured by use of the finest materials such as quality condensers, overrated resistors, RCA designed coils and transformers, etc.
 - * **RMA Guarantee**
 Free replacement of defective parts or tubes within 90 day period. Picture tube guaranteed fully for six months at no extra charge!
- PRICE COMPLETE.
 LESS PICTURE TUBE.....NET **\$164.95**
 NO ADDITIONAL TAXES TO PAY

TELEVISION PICTURE TUBES
Standard Brands
 SIX MONTH GUARANTEE

* 12½" (Black or White)...	\$26.50	Glass 16" Round (Black)	\$39.50
* Glass 14" Rectangular (Blk.)	\$29.50	Glass 16" Rectangular (Blk.)	\$39.50
* 17" Rectangular (Blk.)	\$42.50		
* 19" Round (Blk.)	\$69.50		
* 20" Rectangular (Blk.)	\$73.50		

TELEVISION CABINETS
 16" or 17" Table Model Cabinet
 * A gorgeous table model cabinet for the average size living room. Outside dimensions 23¼" Wide x 24" High x 24" Deep. **\$44.50**
 * Walnut or Mahogany.....

16" Economy Console Cabinet
 * An exceptional buy in a console cabinet made of fine veneers to house the 630 TV chassis, tube and speaker. Outside dimensions are 39" High x 24" Wide x 22¼" Deep. **\$49.50**

16" or 17" PERIOD CONSOLE
 * Handsomely styled for the conventional living room. Has a drop-door panel to conceal control knobs when desired. Outside dimensions are 41" High x 26" Wide x 24" Deep. **\$64.95**

* Above cabinets available for 19" or 20" tubes at \$5.00 additional.

* We are now authorized Distributors for the famous Masco line of high fidelity Amplifiers, Public Address Systems, Tape Recorders, Inter-Communication Systems, etc. Write for latest Catalog.

* All Merchandise Subject to Prior Sale. All Prices Subject to Change without Notice.

WRITE FOR COMPLETE CATALOG C4

* **RADIO DEALERS SUPPLY CO.**
 * 154 Greenwich St. New York 6, New York

Vice-Admiral Edwin Dorsey Foster, U.S. Navy (Ret.) has been appointed director of the newly established Mobilization Planning Department of the RCA VICTOR DIVISION. Mr. Foster was formerly in the office of the Secretary of the Navy.



E. D. FOSTER

RCA also announced the appointment of Theodore A. Smith as assistant general manager of the Engineering Products Dept. He formerly headed sales activities in this department. Mr. Smith takes over the duties of W. Walter Watts, vice-president and general manager of the Engineering Department, who was granted a leave of absence to serve with Defense Production Administrator William H. Harrison.



R. M. BOWIE

Dr. R. M. Bowie, former manager of the Physics Laboratory of PENNSYLVANIA ELECTRIC PRODUCTS at Bayside, N. Y., was named to the staff of the vice-president of engineering. Dr. Bowie is the inventor of the ion trap, which prevents the formation of ion spots on the screen of cathode-ray tubes.

Sylvania also announced the appointment of Leon C. Guest, former comptroller of the Television Picture Tube Division, as comptroller of the Radio and Television Division. Roy E. Drew succeeds him as comptroller of the Television Picture Tube Division.

David C. Prince, vice-president of GENERAL ELECTRIC and head of the G-E General Engineering Laboratory, was named to the president's staff. Harry A. Winne, vice-president in charge of engineering policy, has been assigned the responsibility formerly held by Mr. Prince. Ernest E. Johnson assumed the newly created position of general manager of the laboratory.

J. Fraser Cocks, Jr. has been appointed general comptroller of the AEROVOX CORPORATION and its subsidiary the ELECTRICAL REACTANCE CORPORATION. Carl Gulbanson succeeded Mr. Cocks as comptroller of the Aerovox Corporation. Leonard Wiggins continues as comptroller of the Electrical Reactance Corporation.



J. F. COCKS, JR.

Dr. A. V. Astin, former chief of the Electronics and Ordinance Division of the NATIONAL BUREAU OF STANDARDS, has been appointed associate director of the Bureau. Dr. Astin is best known

* VOLOMETERS

MODEL 102
 (1000 ohms per volt meter)

- * 3" SQUARE METER
- * 3 AC CURRENT RANGES (0-30/150/600 ma.)
- * Same zero adjustment for both resistance ranges (C-1000 ohms, 0-1 megohms)
- * 5 DC & 5 AC Voltage Ranges to 3,000 Volts
- * Also 4 DC Current Ranges.



\$14.90



MODEL 104
 (20,000 ohms per volt meter)

- * 4½" SQUARE METER
- * (50 microamperes—Alnico magnet)
- * Includes carrying strap for 5 DC Voltage Ranges to 20,000 ohms/volt to 3,000 V.; 5 AC Voltage Ranges to 3,000 V. 3 Resistance Ranges to 20 meg. Also 3 AC & DC Current Ranges at 5 DB Ranges.

\$26.95

All of the above have round cornered, bakelite, molded cases. (*Reg. Trade Mark for Volt-Ohm-Milliammeter) Export Dept. 303 W. 42nd St., N.Y.C. Write Dept. B-4 for Free Catalog

Gives More Measurement Value Per Dollar

ELECTRONIC MEASUREMENTS CORPORATION
 280 Lafayette St., New York 12, N.Y.

PHILMORE SENSATIONAL NEW 31 TUBE CUSTOM BUILT TELEVISION CHASSIS

NEWLY DESIGNED!
 HIGH EFFICIENCY — 60° to 70° DEFLECTION SYSTEM



Improved 630-type circuit

\$189.50

less pic tube

FOR ALL 12" TO 20" TUBES ROUND OR RECTANGULAR

With new Philmore Universal bracket assembly for all glass or metal, round or rectangular tubes. Fast action keyed automatic gain control eliminates plane flutter and simplifies tuning. The new Philmore voltage doubler runs up to 16,000 v. Enough to operate 20" picture tubes with POWER TO SPARE. Order Model CP-731-D

GE-SHELDON PICTURE TUBES

12LP4A	\$26.15
14BP4	26.25
14CP4	26.50
16AP4A	44.00
16CP4	38.20
16KP4	40.60
19EP4	61.75
20CP4	66.35
17BP4A	39.35

Write for Free F. Y. I. Flyer Address Orders to Dept. RE-4 or call MULberry 2134

WHOLESALE RADIO PARTS CO., Inc.
 311 W. Baltimore St.
BALTIMORE 1, MD.

for his work in the development of proximity fuses for bombs and rockets. He also has contributed important research and development in the field of dielectrics and electronic instrumentation and other branches of electronics.



A. V. Astin

A. E. Sinclair joined the FEDERAL TELEPHONE AND RADIO CORPORATION as industrial relations director. Mr. Sinclair has been active in this work for many years for such companies as Zenith and Mallory, as well as others. Before joining Federal he was with the Philadelphia Transportation Company.



A. E. Sinclair

Glen McDaniel, 39-year old lawyer and a former vice-president of RCA, was elected first full-time paid president of the RTMA. He joined the Radio Corporation of America in 1946 and was elected a vice-president two years later. Mr. McDaniel takes office April 1st. On this date, Robert C. Sprague, current president, relinquishes the office of president but continues as chairman of the Board. James D. Secrest continues in his position as general manager and secretary of the association.



G. McDaniel

Personnel Notes

... J. B. Swan of the PHILCO CORPORATION has been appointed chairman of the RTMA Traffic Committee. He succeeds Richard C. Colton of the RCA Service Division.
 ... Robert W. Lee, retired president of Johns-Manville has joined OLIN INDUSTRIES in an executive capacity.
 ... Dudley L. Miller was elected a director of BRUSH BERYLLIUM COMPANY and the BRUSH LABORATORIES COMPANY.
 ... Arthur L. Morrison has been appointed purchasing agent of the WESTON ELECTRICAL INSTRUMENT CORPORATION. He succeeds George T. Deaney, who was named war activities coordinator.
 ... William H. Clithero has joined NATIONAL UNION'S Renewal Sales Division as district manager for the southwest territory. He was formerly with the Western Electric Company and the Houston Electrical Supply Company.
 ... N. J. Peterson was appointed a sales manager with responsibility for sale of the GENERAL ELECTRIC Tube Division's products to Federal Government agencies. G-E also announced appointment

Practical, Popular-priced Books on
RADIO•AUDIO•SERVICING

TWO NEW \$1.00 BOOKS



No. 43 MODEL CONTROL BY RADIO by Edward L. Safford, Jr., 112 pages. An authority in the field of radio control gives you the first complete book on the subject. For beginner and expert. Tells you what radio control is, how it works and how to construct not only component parts but a complete system as well. Illustrations explain each step.

No. 42 HIGH-FIDELITY TECHNIQUES by James R. Langham, 112 pages. You've never seen a technical book like it! Just as he'd talk to you across the work bench, RADIO-ELECTRONICS' popular audio writer tells you how to design your own equipment and how to get top performance from it. Takes the double talk out of high-fidelity work.

THREE IMPORTANT 75¢ BOOKS

No. 41 PUBLIC-ADDRESS GUIDE—80 pages. This handy book shows the service technician the way to extra income in big-paying PA work. Covers installation, maintenance and construction.
No. 40 THE CATHODE-RAY OSCILLOSCOPE—112 pages. A "must" for servicing TV, FM and AM receivers and in amateur operation! Tells in simple, but technically sound language, how the 'scope works and how to use it.
No. 39 PRACTICAL DISC RECORDING—96 pages. Tells you how to make good disc recordings. Covers every phase, theory as well as technique. A full chapter is devoted to each component.



10 POPULAR 64-PAGE BOOKS — 50¢ EACH



- No. 29—HANDY KINKS AND SHORT CUTS.** A treasury of time savers! Antennas, power supplies, test equipment, phonographs, amplifiers. Easy reference. Illustrated.
- No. 30—UNUSUAL PATENTED CIRCUITS.** A gold mine of important hook-ups. Control circuits, detectors, amplifiers, power supplies, foreign circuits.
- No. 31—RADIO QUESTIONS & ANSWERS.** Answers the tough ones on circuit diagrams, amplifiers, receivers, transmitters, meters and test equipment.
- No. 32—ADVANCED SERVICE TECHNIQUE.** A "must" for the advanced service man! Covers specialized problems of servicing not usually found in ordinary textbooks.
- No. 33—AMPLIFIER BUILDER'S GUIDE.** For the designer and builder of audio equipment. Covers a variety of amplifiers with power outputs from 8 to 30 watts.
- No. 34—RADIO-ELECTRONIC CIRCUITS.** For the experimenter—circuit diagrams of intercom systems, power supplies, voltmeters, electronic relays, receivers, etc.
- No. 35—AMATEUR RADIO BUILDER'S GUIDE.** For the "ham" who builds his own. Receivers, transmitters, antennas, converters, etc. Practical construction data.
- No. 36—RADIO TEST INSTRUMENTS.** Practical construction data on signal tracers, capacity meters, portable and bench multi-checkers, voltmeters, etc.
- No. 37—ELEMENTARY RADIO SERVICING.** How to get started and keep going! Planning the shop, circuit checks, signal tracing—other fundamental servicing problems.
- No. 38—HOW TO BUILD RADIO RECEIVERS.** Describes 18 modern sets including short wave, broadcast, vhf, portable, ac-operated, ac-dc, miniatures—types for every fan.

RADCRAFT PUBLICATIONS, INC.
 25 West Broadway New York 7, N. Y.

SEE YOUR DISTRIBUTOR OR MAIL THIS COUPON TODAY

RADCRAFT PUBLICATIONS, INC. Enclosed is \$..... for which please send me postpaid, the books checked below.

25 West Broadway, New York 7, N. Y.

29 30 31 32 33 34 35 36
 37 38 39 40 41 42 43

Name.....
 Street.....
 City..... Zone..... State..... 41

4 SENSATIONAL VALUES

for immediate delivery from stock

TEST-CRAFT Model TC-10 Quality Multitester



Only \$12.85

AC and DC Voltage Ranges: 0-5/15/150/1500/3000 Volts. DC Current Ranges: 0-5/50 ma. 0-1.5 Amps. Resistance Ranges: 0-100 ohms, 0-100 K. Size: 6"x3 1/2"x2". Complete with batteries and full instructions.

TEST-CRAFT Model TC-75 Combination Test Speaker and Signal Tracer

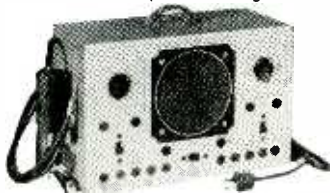

Only \$29.50

plus speaker substitution plus resistor tester plus condenser tester plus output indicator Complete with full instructions

TEST-CRAFT Model TC-50 Tube and Set Tester

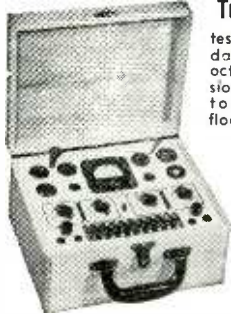

tests all tubes up-to-date incl. 4, 5, 6, 7L, octals, loctals, television, magic eye, thyristors, single ended, floating filament, mercury vapor, new miniatures, etc.

Multimeter Specifications: AC and DC Voltage Ranges: 0-1, 100, 1000-5000. DC Current Ranges: 0-10/100/1 Amp. Low Resistance Range: 0-10,000 Ohms. Medium Resistance Range: 0-100,000 Ohms.

Only \$39.50

High Resistance Range: 0-1 megohm. Complete with test leads and full instructions

MODEL 999 Combination F.M. and A.M. Signal Generator and Signal Tracer



Only \$28.85

Generates R.F. frequencies from 150 kilocycles to 50 megacycles. Battery operated, no external source of current required. Positive action attenuator provides effective output control at all times. R.F. is obtainable separately or modulated by the Audio Frequency. Complete with test leads and full instructions 25% with order, balance C.O.D. or full check with order.

**METROPOLITAN
ELECTRONICS & INSTRUMENTS CO.**
Dept. B
106 Fifth Ave., New York, N.Y.

of J. W. Duffield as regional sales manager for the Eastern division.

... Wilmer T. Spicer has been named chief engineer of maintenance by Bendix Radio Division of BENDIX AVIATION. He will be responsible for the administration of the Technical Publications and Field Engineering departments.

... J. J. Brophy has been appointed production manager of HELIPOT CORPORATION, South Pasadena, Cal.

... John R. Howland has joined STEWART-WARNER as head of the newly created corporation office of Product Research. He was formerly assistant to the president of Zenith Radio Corporation. The new office was created to encourage inventors both within and outside the company and to develop new products.

... Harry H. Erickson, formerly service manager of APPLIANCE DISTRIBUTORS, INC., Chicago factory branch of Admiral, was promoted to service manager of all the company's branches. His job will be mainly to coordinate and intensify branch service operations to insure good customer service.

... Everett S. Lee has been appointed editor of *General Electric Review*, monthly engineering magazine of the GENERAL ELECTRIC COMPANY. He succeeds Edward C. Sanders, who has been executive editor of the publication since 1926.

... David Krantz, an executive in service technicians associations in Philadelphia and elsewhere in Pennsylvania has retired from his retail record and radio repair business to devote more time to the PHILADELPHIA SERVICE CORPORATION of which he is president. He has been in the radio repair business for over 18 years.

- END -

TELEPHONE CARRIER FOR SHORT RANGES

Improved telephone cables for short haul service provide for 12 high-quality telephone circuits simultaneously on only two pairs of wires. Improvements in miniaturized circuits and some entirely new concepts have been combined to provide an economical carrier system for distances ranging from 20 to 200 miles. Previously carrier systems have been economical only for long hauls.

Developed at the Bell Telephone Laboratories, the system requires only one cable for transmission in both directions, whereas two cables were previously required. Different frequency bands are used for transmission in the two directions, and these are interchanged at each repeater to minimize crosstalk and provide other advantages. Terminal equipment takes up about one-fifth the space necessary for previous carrier systems, and all the major units are designed on a plug-in basis.

Two of the new systems have been installed between Harrisburg and Sunbury, Pa., each with five repeaters, and the New York Telephone Company has installed ten between Brooklyn and Riverhead, N. Y.

- END -

7 HARD TO GET ITEMS AT BIG SAVINGS TO YOU

AMAZING BLACK LIGHT



250-watt ultra-violet light source. Makes fluorescent articles glow in the dark. Fits any lamp socket. For experimenting, entertaining, unusual lighting effects. Ship. wt. 2 lbs. ITEM NO. 87 A SAVING AT \$2.45

LITTLE GIANT MAGNET

Lightweight 4 oz. ALNICO permanent magnet. 1 3/4" x 1 1/2". Lifts more than 20 TIMES ITS OWN WEIGHT! Ideal for hobbyists, experimenters. Shipping weight 3/4 lbs.



ITEM NO. 159 BIG VALUE AT \$2.45

POWERFUL ALL PURPOSE MOTOR

Sturdy shaded pole A.C. induction motor. 15 watts, 3000 rpm. 3"x2"x1 1/4". 4 mounting studs; 7/8" shaft, 3/16" diameter; 110-120 volts. 50-60 cycles. A.C. only. When geared down, this unit can operate an 18" turntable with a 200 lb. dead weight. Use it for fans, displays, timers and many other practical purposes. Ship. wt. 2 lbs.

ITEM NO. 147 UNUSUAL BUY \$2.45

WATTHOUR METER

Leading makes — completely overhauled, ready for service. 100-110 volts, 60 cycles, 2-wire A.C. 5 amp. Heavy metal case 8 1/2" x 6 1/2" x 5". Easy to install. Shipping weight 14 lbs.



ITEM NO. 33 NOW ONLY \$4.50

WESTERN ELECTRIC BREAST MIKE

Lightweight 1 lb. carbon microphone. Aircraft type. Breastplate mounting, adjustable 2-way swivel. Easily fastened straps. For home broadcasts, communications etc. Complete with 6 foot cord, hard rubber plug. Sherardized plate, non-rusting finish. Ship. wt. 2 lbs.

ITEM NO. 152 NEW LOW PRICE \$1.10

TELEPHONE TRANSMITTERS

Genuine transmitters made by Kellogg, Western Electric, Stromberg Carlson Work on two dry cells For P.A. systems, Intercoms, other practical uses. Shipping weight 1 lb.



ITEM 160 REAL VALUE \$2.45

250 POWER TELESCOPE LENS KIT

Make your own high powered 6 ft. telescope! Kit contains 3" diam., 75" focal length, ground and polished objective lens and necessary eye pieces. Magnifies 50x to 250x. Full instructions. Ship. wt. 1 lb.

ITEM NO. 123 YOU SAVE AT \$2.95

HUDSON SPECIALTIES CO.
40 West Broadway, Dept. RE 4-51
New York 7, N. Y.

I am enclosing full remittance for items circled below. Shipping charges included.

OR, my deposit of \$..... Ship balance C.O.D.
MINIMUM C.O.D. ORDER \$5.00.

C.O.D. ORDERS ACCEPTED ONLY WITH 20% DEPOSIT
INCLUDE SHIPPING CHARGES.

Circle items wanted

87	159	147	33	152	160	123
----	-----	-----	----	-----	-----	-----

Name.....
Please Print Clearly
Address.....
City..... Zone..... State.....

CRYSTALS Low Freq.

FT-241. A holder 1/2" Pin spacing, for ham and general use. Xtal controlled. Signal Generators, Q=57RS, S.S.B. Exciters (Nov. QST) marked in army harmonic frequencies—Directions for deriving fundamental frequencies enclosed. Listed below by fundamental frequency, fractions omitted.

370	419	444	485	512	391	447
372	420	445	486	513	392	448
374	422	446	487	514	393	450
375	423	458	488	515	394	451
376	424	459	490	516	395	453
377	425	461	491	518	396	454
379	455	462	492	519	397	455
380	427	468	493	520	398	456
381	429	469	494	522	400	457
383	430	470	495	523	401	463
384	431	472	496	525	402	465
385	433	473	497	526	403	498
386	434	474	492	527	404	500
387	435	475	503	529	405	501
388	436	476	504	530	406	538
412	437	477	505	531	407	540
413	438	479	506	533	408	
414	440	480	507	534	409	
415	441	481	508	536	411	
416	442	483	509	537	each	
418	443	484	511	390	69c	\$1.49

1% PRECISION RESISTORS

.6	468	33.000
1.01	800	40.000
5	920	55.000
3.05	1100	57.000
10.1	4300	75.000
18	5000	84.000
33.5	7500	30c ea.
50	8500	10 For \$2.50
75	10,000	10 For \$2.50
82	10,000	10 For \$2.50
120	10,000	120.000
125	12,000	120.000
128	12,000	150.000
150	17,000	220K
128	17,300	250K
250	20,000	30c ea.
300	25,000	10 For \$3.50
430	30,000	10 For \$3.50

Attention CAP MEN!!!

Attention CAP Men!!!
BC 429
3-gang TRF non-radiating receiver, designed for aircraft use, complete with tubes and C-438 tuning unit covering 200-400 kc and 2500-4700 kc, less p.w.r. sub. \$3.95

T.U. for BCAR 230 or 430

3.2-4MC
5-5.2MC
1.2-1.5MC
1-1.2 MC
Price 95c ea.
4-5MC w/ 4495KC XTAL \$2.79 ea.

GIBSON GIRL



The Emergency Radio Transmitter. Send S O S signals automatically on 500KC. 150-mile range. No batteries required. Has hand-driven generator tubes, wire. It's only \$3.40

RC-605 INTERPHONE AMPLIFIER
Easily converted to an ideal inter-communications set for office-home or factory. Original. New w/conversion diagram. \$4.49

Rated Capacitors Send P.O. Aluminum Order \$3.00
Send M.O. or CHK. Mds. Guard. Shpg. Charges
Sent C.O.D. Price F.O.B. N.Y.C. Phone Di. 9-4124

COMMUNICATIONS EQUIPMENT CO.
131 Liberty St. Dept. C-4 New York City 7, N. Y.

SWEETNESS AND LIGHT

Dear Editor:

I've been a constant reader of your magazine for five years, but not in the true sense of being a radio repairman or technician, as you call them. I'm more of an experimenter within my scope and means.

I'm afraid I haven't the slightest thing to criticize about your magazine. You treat all electronic subjects and departments fair and square. Maybe in the future Montreal will have a TV transmitter; then I shall be able to enjoy your television articles more. Until then I'll continue to read them with some interest so I'll know what to expect. Anyone who doesn't progress must slide down grade. You simply can't mark time!

Would you forward my respects to James Langham. I thoroughly enjoy his articles and his method of dispensing with "gobbledgook." Tell him to "get crackin'" on some more audio articles. And keep up the Electronic Brain series. I find it very interesting. In all, let me congratulate you on a fine publication.

R. F. SHORTEN

Bishopton, Quebec

CORRECTIONS

The value of resistor R1 was omitted from the list of parts for the transmitter in Fig. 5 of the article "Elementary Design for Radio Model Control" in the March, 1951 issue. The correct value is 27,000 ohms, 1/2 watt, as shown in Fig. 5.

In the article, "Relays and their Operation Part II" in the March, 1951 issue, reference is made to Fig. 11-a in the first paragraph on page 54. This is in error and should read Fig. 14. The two transformers in Fig. 15 may be the same as T1 and T2 in Fig. 14, but need not have center taps.

TECHNICAL JOBS

The stepped-up national defense program has created more than 300 civilian position vacancies for engineers and other technical personnel at the Army Engineer Research and Development Laboratories at Fort Belvoir, Va. The positions are covered by Civil Service regulations and carry salaries up to \$6,400 per year.

Immediate vacancies exist for electrical, electronic, mechanical, civil, chemical and photogrammetric engineers, technical writers and architects. Also needed are draftsmen, and engineer aids (sub-professional) as well as a long list of technicians such as model makers, steamfitters, engineer equipment operators, and others.

Applicants should write to: Commanding Officer, Engineer Research and Development Laboratories, Fort Belvoir, Virginia. A completed Civil Service Form 57 should be forwarded, if possible. These forms may be obtained from any U. S. Civil Service Commission Office, or the post office.

MORE THAN 50,000 TV SETS MONTHLY

rightly rely on

J S C
Twin Lead
300 ohm
Television
Transmission
Wire

TV manufacturer, installation engineer, TV sponsor and televiewer all form an inseparable chain, securely linked by the world's finest television transmission wire. J S C is justly proud of its important role in the development and progress of television. Rigid adherence to the principle of "quality before quantity" will pave the way to greater accomplishments for J S C I

Write for Descriptive Pamphlet.

JERSEY SPECIALTY CO.
Little Falls, New Jersey
All Phones:
Little Falls 4-0784, 1404, 1405

Sky Hi

TELESCOPING TELEVISION MAST

With the SKY-HI Mast, installations are easy to install. No climbing is necessary—telescoping sections and hinged base make it possible to install and service from ground without the use of ladders.

The SKY-HI Television Mast is raised and lowered hydraulically. Automatic latches on each section hold mast in rigid position and can be released from the ground. Guy wires are attached to each section before raising.

40' to 100' GROUND INSTALLATIONS

LATCHED POSITION TELESCOPED

Write for descriptive literature

10' to 40' ROOF MOUNTS AVAILABLE
LIMITED TERRITORIES AVAILABLE

THOMAS MOLD & DIE CO.
WOOSTER, OHIO

LEARN

Television - Radio - Electricity

OR

Electricity

IN THE GREAT SHOPS OF **COYNE**

COYNE
53 YEARS

TRAIN QUICKLY!
OLDEST, BEST EQUIPPED SCHOOL of ITS KIND in U.S.
Young and Older Men

Come to the Great Shops of Coyne in Chicago. Get practical training in TELEVISION-RADIO or ELECTRICITY—vital in Defense Program. Prepare now for a better job or better service rating.

START NOW—PAY LATER
You can finance most of your tuition, pay for it later in easy monthly payments. Special plan for men of Draft Age. Part time employment service available. **GI APPROVED**

FREE BOOK Clip coupon for Big Free Illustrated Book. Indicate below, course that interests you. No salesman will call. Act NOW.

An Institution not for Profit

B. W. COOKE, Pres.
COYNE Electrical & Television-Radio School,
500 S. Paulina St., Chicago 12, Ill. Dept. 41-81H

Send FREE BOOK and full details on:

TELEVISION-RADIO ELECTRICITY

NAME.....
ADDRESS.....
CITY..... STATE.....

Prepare Now!

RADIO ENGINEERING

B. S. DEGREE IN 27 MONTHS

Complete Radio Engineering course incl. Telev., U.H.F. and F.M. BS Degree Courses also in Mech., Civil, Elect., Chem. and Aero Eng.; Bus. Adm., Acct. Extensive campus, modern buildings, well equipped labs. Low cost. Prep. courses. Personalized instruction. Heavy demand for graduates. Placement service. Founded in 1884. Prepare now for the civil and military opportunities ahead. **VETERANS:** You may still obtain training and a college degree at Tri-State College under present G.I. Bill. Last opportunity for new students to enroll is Summer Quarter, June 11, 1951. Hundreds of Tri-State veteran graduates are holding responsible positions with unlimited opportunities for future advancement. Enter March, June, Sept., Jan. Write for Catalog.

TRI-STATE COLLEGE
2441 COLLEGE AVE. ANGOLA, INDIANA

LEARN DAY and EVENING CLASSES

TELEVISION

ELECTRONICS-RADIO
Modern Laboratory Instruction in

- SERVICING
- BROADCAST OPERATING
- ELECTRONIC and TV ENGINEERING

G.I. APPROVED

WRITE FOR ILLUSTRATED CATALOG

ELECTRONICS INSTITUTE, Inc.
21 HENRY, DETROIT 1, MICH.

PRESENTING...

A NEW department of the DON MARTIN SCHOOL OF RADIO AND TELEVISION ARTS AND SCIENCES . . . for instruction and training in—**TELEVISION**—incorporating:

Production: Writing, Directing, Producing, Acting, Staging, Lighting.

Engineering: Transmission, Receiving, Camera and Studio, Operation, Theory of Video, Pickup and Reproduction.

Approved for veterans.

THE DON MARTIN SCHOOL OF RADIO AND TELEVISION ARTS AND SCIENCES
1655 No. Cherokee, Hollywood 28, Calif. HU. 23281.



RADIO COURSES

Preparatory Mathematics, Service, Broadcast, Television, Marine Operating, Aeronautical, Frequency Modulation, Radar.

Classes now forming for the Summer term beginning June 1st Entrance exam, May 21st

Veterans. Literature.

COMMERCIAL RADIO INSTITUTE
(Founded 1920)
38 West Biddle Street, Baltimore 1, Md.

AUDIO ENGINEERING SCHOOL

Practical engineering training in Audio fundamentals, Disc, Film, Magnetic Recording, and Audio frequency measurements. Studio training simulates Broadcast, Motion Picture, Television, and Commercial Recording work. Approved for Veterans

HOLLYWOOD SOUND INSTITUTE, Inc.
1040-E North Kenmore, Hollywood 27, Calif.
Specify if Veteran or Non-Veteran

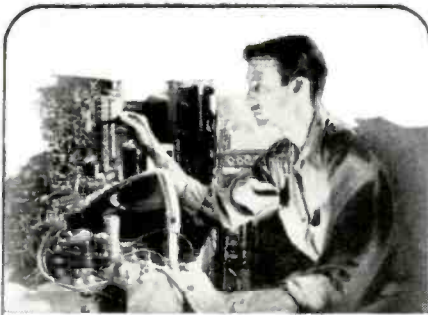

BUILD YOUR CAREER AS AN ELECTRICAL ENGINEER

thru this Proven Plan

As a young man with a career to build, you may today be interested primarily in training for Radio — and perhaps for TV. But — *who knows* . . . you may some day have both the desire and opportunity to climb further and become an Electrical Engineer! Here, then, is a world-renowned educational plan that permits you to use your Radio training as a major stepping-stone to an even greater career.

IN 12 MONTHS BECOME A RADIO TECHNICIAN

Train here for radio shop operator or serviceman, mobile receivers and all types of transmitters, and for supervision of service personnel. You may then advance immediately, or at any future date, into courses described below.

IN 6 ADDITIONAL MONTHS you become a Radio-Television Technician

An additional 6-months course gives you intensive TV Technician's training — under the *personal guidance* so necessary in this expanding field.

ALSO...YOUR RADIO COURSE IS FULL CREDIT TOWARD THE B.S. DEGREE IN ELECTRICAL ENGINEERING

The Radio course, while complete in itself, is *one-third* of the college program (major in Electronics). Further — you are guided scientifically toward specialization beyond basic engineering training.



B.S. DEGREE IN 36 MOS.
Military, practical or prior academic training evaluated for advanced credit. Terms open April, July, October, January.

MILWAUKEE SCHOOL of ENGINEERING

Technical Institute • College of Electrical Engineering

FREE—Write for "Occupational Guidance Manual" and 1951 Catalog.

MILWAUKEE SCHOOL OF ENGINEERING
Dept. RE-451, 1020 N. Broadway Milwaukee, Wis.

Without obligation, mail Occupational Guidance Manual on:

Radio-TV Electrical Power Welding
 Heating, Refrigeration, Air Conditioning

Also send 1951 Catalog for Electrical Engineering, B.S. degree in Electric Power Electronics

Name.....Age.....
Address.....
City.....Zone...State.....
 Check if World War II Veteran

RADIO SCHOOL DIRECTORY

TELEVISION

PREPARE FOR A GOOD JOB!
COMMERCIAL OPERATOR (CODE)
RADIO SERVICEMAN
TELEVISION SERVICING
BROADCAST ENGINEER

Approved for Veterans
SEND FOR FREE LITERATURE

BALTIMORE TECHNICAL INSTITUTE
1425 Eutaw Place, Dept. C, Baltimore 17, Md.

V RADIO ENGINEERING
FM—Television—Broadcast

Police Radio, Marine Radio, Radio Servicing, Aviation Radio and Ultra High mobile applications. Thorough training in all branches of Radio and Electronics. Modern laboratories and equipment. Old established school. Ample housing facilities. 7 acre campus. Small classes, enrollments limited. Our graduates are in demand. Write for catalog.

Approved for Veterans
VALPARAISO TECHNICAL INSTITUTE
Dept. C VALPARAISO, INDIANA

RADIO ENGINEERING 27 MONTHS DEGREE

Intensive, specialized course including strong basis in mathematics and electrical engineering, advanced radio theory and design, television. Modern lab. Low tuition. Self-help opportunities. Also 27-month courses in Aeronautical, Chemical, Civil, Electrical, and Mechanical Engineering. Approved for G.I.'s. Enter June, Sept., Dec., March. Catalogue.

INDIANA TECHNICAL COLLEGE
154 E. Washington Blvd., Fort Wayne 2, Indiana

RADIO COURSES

- RADIO OPERATING • CODE
- RADIO SERVICING • ELECTRONICS
- F.M. TELEVISION

Preparation for Civilian, Maritime, Army and Navy license requirements.
Write for Catalog TE

Y.M.C.A. TRADE & TECH. SCHOOL 229 W. 66 St., N. Y. 23
ENdicott 2-8117

CODE SENDING RECEIVING SPEED

Be a "key" man. Learn how to send and receive messages in code by telegraph and radio. Commerce needs thousands of men for jobs. Good pay, adventure, interesting work. Learn at home quickly through famous Gaudier System. Quality for Amateur or Commercial License. Write for FREE BOOK.

CAMPBELL SYSTEM CO.
Dept. S-D, Box 928, Denver 1, Colo., U.S.A.

AUDIO (SOUND) ENGINEERING HOME STUDY TRAINING

Practical, easy-to-understand lessons, written by competent Audio Engineers and Educators, prepare you for a better job and a good future in the Television, Radio, Motion Picture, and Recording Industries.

Write today for details—Learn while you earn!!

HOLLYWOOD TECHNICAL INSTITUTE
Div. RE
4925 Santa Monica Blvd. Hollywood 27, California

TELEVISION

Laboratory and theoretical instruction covering all technical phases of Radio, FM, Television. Leads to opportunities in Broadcasting, Industry or Own Business.

TOTAL TUITION \$450. NO EXTRAS.
Morn., Aft., or Eve. Small Weekly Payments.
Approved for Veterans. Enroll Now.

RADIO-TELEVISION INSTITUTE
Pioneers in Television Training Since 1938
480 Lexington Ave., N. Y. 17 (46th St.)
Plaza 9-5665 Licensed by N. Y. State

RCA RADIO and TELEVISION

Thorough Training in All Technical Phases

APPROVED FOR VETERANS

DAY—EVENINGS WEEKLY RATES
FREE PLACEMENT SERVICE FOR GRADUATES
For Free Catalog Write Dept. RC-51

RCA INSTITUTES, Inc.
A Service of Radio Corporation of America
350 WEST 4TH STREET NEW YORK 14, N. Y.

MOVIES FOR TV, by John H. Battison. Published by The Macmillan Co., New York. 5 1/4 x 8 1/2 inches, 375 pages. Price \$4.25.

With a large portion of television programs being made up of full-length feature films, shorts, news reels, and filmed commercials, it is important that studio technicians, directors, producers, and other studio personnel be familiar with the techniques and applications of motion pictures. To this end, the author has prepared a guide which provides useful information on TV programming and on the technical equipment needed to obtain optimum results from movies on television.

First to be discussed are the principles and operation of TV transmitting equipment and equipment used in making and producing movies. This includes detailed descriptions of the leading movie cameras, methods of recording sound, special effects, lighting, projectors, and movie accessories. Also included in this section of the book are chapters on color, continuity, editing, and the techniques of making movies for TV.

The second part of the book has 12 chapters devoted to the details of programming and production. Such problems as planning, use, and selection of different types of films; lighting, shooting, and processing film are discussed in some detail.

The concluding chapter "Copyrights and Releases" covers many of the legal aspects of using film and reveals many of the troubles and inconveniences which can arise from televising some types of subject matter or film without having full rights to do so.—*RFS*

TELEVISION RECEIVING EQUIPMENT, third edition, by W. T. Cocking. Published for *Wireless World* by Iliffe & Sons, Ltd., London, England. 5 1/4 x 8 3/4 inches, 375 pages. Price 18 shillings.

Although British TV standards are somewhat different from those in the U.S., the circuits used are basically the same and readers of this book will find them explained in a lucid and readable style. The author, editor of *Wireless Engineer*, has revised this edition to bring it in line with the latest techniques. The appendix provides some useful design equations for some of the more important circuits.

1950 RADIOFILE ANNUAL, compiled and published by Richard H. Dorf, New York, N. Y. 6 x 9 inches, 22 pages. Price 50¢.

The annual issue of the bi-monthly *Radiofile*, this little work indexes radio material in 14 principal technical publications (including *RADIO-ELECTRONICS*) by subject. Short items which do not appear in various magazine's tables of contents are indexed as well as the main articles. Articles are also roughly classified in four categories: theory and design; construction and modification; description and discussion; charts and visual aids.

BELIEVE IT OR NOT!

630 TS

TYPE CHASSIS
MFG. LICENSED UNDER
R.C.A. PATENTS

30 TUBE CHASSIS

- 1 Best for Fringe Areas
- 2 Improved Keyed A.G.C.
- 3 Full 4 Megacycle Band Width
- 4 16 KV Output
- 5 A.F.C. Sync. Separator Syncroklok
- 6 Latest 1951 Features
- 7 Focus Coil-Yoke Removable Plugs
- 8 Standard Tuner
- 9 Improved Down to 45 Microvolts
- 10 Set equipped with Phono Jack
- 11 Set uses 70° Deflection Coil
- 12 Complete Chassis with Tubes Aligned. Not a Kit
- 13 Large 12" Speaker
- 14 All Knobs—Channel Selector
- 15 Universal Mounting Brackets. Tube on Chassis
- 16 Free Plastic Mask with Every Set
- 17 Free Schematic with Every Set
- 18 Free R.M.A. Guarantee on Chassis-Tube
- 19 Free—No Extras—Tax Included
- 20 Free Delivery on Paid Order 6 or More
- 21 Dumont Tuner F.M. Radio \$10 Extra
- 22 Cabinets—Console 16" 17" 20" \$59
- 23 Cabinets—Half Doors 17" 20" \$69
- 24 Cabinets—Full Doors 17" 20" \$79
- 25 In Mahogany or Blonde. Same price.

COMPLETE CHASSIS
INCLUDING BLACK
RECTANGULAR PIC-
TURE TUBE

16" \$189

17" \$199

20" \$219

24" \$299

25% WITH ORDER
BALANCE C.O.D.

Dealers, Dist., Mfg.
SPECIAL PRICES
LOTS 12 OR MORE

UPSTATE, 107 DUANE, SCHENECTADY, N.Y. TEL. 4-3008

ADSON FOR VALUE!

SERVICEMEN! STUDENTS! HOBBYISTS!

Now, More Than Ever, Arkay Radio Kits Are Your Best Buy for Value and Quality!

With Arkay you get latest design circuits and top quality parts that assure long trouble-free performance—a kit designed to equal ready assembled units. Every kit comes with large, schematic, pictorial diagrams and step-by-step instruction manual.

ARKAY 5-Tube Superhet Kit
This streamlined receiver provides crystal-clear reception thru entire tuning range of 550 KC to 1600 KC. 5-tube improved superhet circuit. 115 V AC-DC. Full size Alnico PM speaker. Complete with handsome cabinet and all tubes.



KIT MODEL S-5 \$14.95

ARKAY 2-Band 5-Tube Receiver Kit
High quality 2-band kit to receive domestic AM signals and foreign short wave. Tuning range: 550 KC to 1600 KC and 5.8 MC to 18 MC. Equipped with high gain coils. Powerful 5" Alnico V PM speaker. Complete with handsome cabinet and all tubes.

KIT MODEL S-6X, 6-Tube 2-Band Receiver. \$18.95

ARKAY 6-Tube FM Tuner
Brings in full range of FM stations from 88 MC to 108 MC. 6-tube circuit provides no-drift tuning for steady reception. Equipped with own volume control and all tubes.

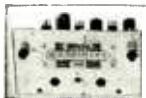

MODEL FM-5 \$31.95

ARKAY 3-Way Portable Receiver Kit—5 tube radio for portable battery operation and AC-DC house use. 550 KC to 1600 KC. Smartly designed leatherette case with modern grille and slide rule dial. 5" Alnico V speaker.
KIT MODEL 3W10A. \$18.45
Satisfaction guaranteed. Send check or money order. 25% deposit with C.O.D. All orders shipped within 24 hours. F.O.B. New York. Please include postage.

PEN-OSCIL-LITE

Extremely convenient test oscillator for all radio servicing; alignment • Small as a pen • Self powered • Range from 700 cycles audio to over 600 megacycles u.h.f. • Output from zero to 125 v. • Low in cost • Used by Signal Corps • Write for information.

GENERAL TEST EQUIPMENT
38 Argyle Ave. Buffalo 9, N. Y.

SHOOT TV TROUBLE FAST!

With H. G. CISIN'S RAPID "TV TROUBLE SHOOTING METHOD"

EARN more money! Locate television troubles by this quick, entirely new method. Rapid checks enable you to locate all faults in record breaking time regardless of make or model! 160 Picture, Master, Sound trouble symptoms. Over 100 Rapid Checks including over-all alignment checks, 26 illustrations; simplified step-by-step directions!

H. G. CISIN, well-known to radio men as a recognized electronic engineer, inventor, technical author and educator, has trained thousands of television technicians, many of them now owning their own prosperous TV service organizations. The results of his years of experience are embodied in this remarkable **TV TROUBLE SHOOTING METHOD**.

INCREASE your earning power with the most valuable aid to TV servicing ever written! SEND YOUR NAME AND ADDRESS TODAY WITH ONLY FOR YOUR POSTPAID COPY. **\$1.00**

RUSH COUPON NOW!

H. G. CISIN, CONSULTING ENGINEER
Dept. E-2, 200 Clinton St., Bklyn. 2, N. Y.

Enclosed is \$....., for which please rush copies (postpaid) of your **TV TROUBLE SHOOTING METHOD**.

Name.....
Address.....
City..... Zone..... State.....

ADSON RADIO & ELECTRONICS CO.
DEPT. 204
221 Fulton Street, New York 7, N.Y.

"TAB" THAT'S A BUY

O.K. TUBE SPECIALS
Tested Perfect—Standard Brands
Keys Broken—Guaranteed

183GT	\$1.33	6L6	\$1.75	6V6	1.59
5U4C	.98	6L6G	1.29	6V6GT	1.00
5V3GT	.88	6P4GT	1.98	6V6GT	\$2.90
6AB7	.96	6SC7	.98	12A6	.59
6AC7	1.45	6SF5	.49	12SA7	.89
6AC7	1.44	6SH7	.66	12SA7GT	1.10
6B6GG	1.84	6SH7	.66	19B6GG	1.79
6H6	.49	6SK7	.90	25L6GT	.54
8J5	.75	6SN7GT	1.10	25W6GT	1.00
6J7	.81	6SQ7	.75	3Z5GT	.75
6K6GT	.75				



SNOOPERSCOPE

Image-Converter Tube HiSensitivity simplified design 2" dia. Williams screen—Resolution up to 350 lines/in. Complete data & tube, "TAB" key, each \$4.98; 2 for \$9.49. Radioactive Markers 1 1/2" OD for Car, Bike, Boat, Clip Type, 5 for 25c. 24 Above in Metal Box w/8 partitions. Slight Corrosion98c



"WILLIAMSON" 10W HI-FI AMPLIFIER KIT

10cvc To 20Kc with Ease! Internationally Famous. To 1Mc for Experimenters. Incl. Pwr Supply, RCA Chassis, Less Pre-Amp & Output Xfmr. \$29.95. *Williamson Pre-Amp Kit & Tone Boost Amplifier \$34.95. *Williamson 32 page Booklet illus. 16c

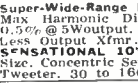

Super-Wide-Range Hi-Fi Kit: 20 eye to 20 Kc. 10W. Max Harmonic Distortion 1 1/2% @ Full Output; 0.5% @ 5W Output. Pre-Amp, Tone Control, Bass Chassis, Less Output Xfmr. \$34.95. SENSATIONAL 10" HI-FI Spkr Ideal 6 Watt Home-Size, Concentric, Separate Driver & Horn Driver Tweeter, 30 to 16000c Range! \$14.



RCA UNIV OUTPUT XFMR

10W, to 10Kc. Matches ANY Line or Spkr w/C's 3 to 4 or 150 ohms to ANY Load & Tube. 2 to 4 det 50 & 10240 ohms. 1000 combinations! Acts as EXC Band Pass Filter or Freq. Attn Unit for Dyn Mike. Cuts HI's or LOWS. IDEAL Lazy Q-S action! CWor Phone. Gets ONLY Signal you WANT to hear. W/data \$1.89; 3 for \$4.89.

WE PAY \$\$\$

TOP DOLLAR for Your SURPLUS TUBES

Receiving • Transmitting • Industrial
NEW or REMOVED FROM EQUIPMENT

Make your BIG PROFIT Now, when Prices are Highest!
Immediate Payment.

We Buy, Trade and Sell Tubes & Surplus Equipment.
Send Us Your Lists and Prices.

WANTED IMMEDIATELY

1M7 1M730	5C22	6J6	6G177	308AS	310, 311
3E70	6C21	12AU7	250TH&L	450TH&L	1A14
4C35	6HG	12EN7	301TH&L	NU27	9001A&3A

866A KIT AND XFMR

2 Tubes, Sekts., xfrm 115v60cye Inpt. output 2.5vct/10A/10Kvms \$6.98
DIODE PROBE Tube, Unsurpassed for UHF Testing, VR92, Ea. 25c; 5 for \$1.00

IN34 XTALS, 75c 10 for \$ 7.30 100 for \$71.00

END EQUIPMENT BUYS!

RADIO COMP RCVR Less Tubes, As Is \$5.40
EES Tel. Incl. Handset, As Is. . . . 3.98
TG5 Keyer, As Is. 5.98
E08 Ringing Gen. Assy. Like New, Less Handset (7S-9), 57-98; Handset for EES. . . 4.98
R9/ARN4 Receiver, Less Tubes, As Is. . 14.98
TG10 Code Unit, Less Tubes, As Is. . . 10.05
R19/MA Variometer Unit, As Is. . . 1.08
M29 Control Unit, BRAND NEW. . . 1.98
R134/AR13 30 Mc. IF, Less Tubes, As Is. . 7.38
R59/TP53 Good, As Is, Less Tubes. . . 29.98
EES Telephone Test Set, Fine Cond. . . 24.98
R65 Time Interval Signal, Used. . . 3.98
R74/CRW Revr., Less Tubes, As Is. . . 2.49
R75/ARN5A, CAA Appvd., Less Tubes. . . 19.98
R67 Plate Supply Unit, Less Tubes. . . 9.98
I-108 Range Calibrator, Metal Case, Good. . 29.18
PE120 Pwr. Supply, Less Tubes, Used Mackay 18B Radio Xmitter, w/Metal Case, Less Vibrapak & Tubes, As Is. . . 2.98
I-198 Sig. Gen., Good Cond., Less Tubes. . 14.98
BC212 Amp, Exc. Cond., Less Tubes. . 4.48
M299 Mike Adaptor, Good Cond. . . . 5.99
EC453 Revr., 1190-550Kc New. . . 24.49
EC454 Revr. (3-6 Mc) New, Less Tubes. . 11.48
EC455 Revr. (6-9 Mc), Dyn., As Is. . . 4.95
EC456 Mod., Less Tubes*, Dyn., As Is. . 1.98
EC457 Xmt., (4-5.3 Mc), LT*, As Is. . 1.98
EC458 Xmt., (7 Mc), LT*, As Is. . . 3.98
SCRS95 IFF, Less Tubes, As Is. . . 3.98
EC602 Cont. Box for 522, As Is. . . 1.29
BC905 Amp, Less Tubes, As Is. . . 3.98
SCR695 IFF, Less Tubes, As Is. . . 4.98
BC733 Revr., Less Tubes, As Is. . . 5.98
BC906 Freq. Div. Exc. Cond., Less Tubes. . 29.98
Projector Unit US Navy BRAND NEW

KLAKS SPECIAL! Brand New for Shower or Beach, Sturdy Wood & Canvas Construction. Popular Size 10, Pair. 39

Write for our FREE CATALOG
Money Back Guarantee (Cost of Mail Only) \$5 Min.
Order FOB NYC. Atl. Ship. Charges & 25% Dep.
Prices Subject to Change Without Notice

"TAB"

Dept. 4 RE, 6 Church St., New York 6, N.Y., U.S.A.
Corner Church & Liberty Sts., R. 200
Phone: WOrth 2-7230

ADVERTISING INDEX

Ad Ritz Manufacturing Company	82
Adson Radio & Electronics Company	111
Airon Radio Corporation	87
Allied Radio Corporation	55
Almo Radio Company	105
American Electrical Heater Company	68
American Phenolic Corp.	100
American Products Corp.	102
Amplifier Corporation of America	113
Amec Electronics Company	91
Atlas Sound Corp.	96
Barry Electronics Corporation	90
Bell Telephone Laboratories, Inc.	6
Boyce-Roche Book Company	62
Brooks Radio Dist. Company	105
Buffalo Radio Supply	98
Capital Radio Engineering Institute	7
Central—Div. of Globe Union	16, 17
Certified TV Laboratories	113
Cisin, H. G.	111
Clarion Metal Products	92
Cleveland Institute of Radio Electronics	11
Coast Electronic Supply Company	102
Color TV Laboratories	97
Commercial Trade Institute	79
Communications Equipment Company	109
Concord Radio Corporation	95
Cornell-Dubilier Electric Corporation	18
Coyne Electrical School	63, 81, 109
DeForest's Training, Incorporated	9
Electronic Instrument Company	122
Electronic Measurements Company	106
Federal Radio Company	102
Faier Engineering Company	92, 105
General Electric Company	19
General Electronic Dist. Company	74, 75
General Industries Company	92
General Test Equipment Company	111
Gonset Company	96
Greylock Electronic Supply	113
Hair-Radio Company	105
Harmonic Manufacturing Company	91
Harvard Laboratories	102
Heath Company	84, 85, 86, 87
Hytron Radio Electronics Corporation	111
Industrial Development Engineers Assoc.	13
Instructograph Company	94
Island Radio Dist.	105
JFD Manufacturing Company	63, 81
Jensen Industries, Incorporated	60
Jersey Specialty Company	109
La Pointe-Plascomold Company	71, 112
Leotone Radio Corporation	96
Lornet Products Company, Inc.	79
Marrow-Hill Radio Company	113
Macmillan Company (The)	69
Mallory & Company, Inc., P. R.	Inside Back Cover
Merit Transformers Company	12
Metropolitan Electronics & Instrument Company	108
Midwest Radio & TV Corporation	104
Miles Reproducer Company	102
National Radio Institute	3
National Schools	5
National Union Radio Corporation	67
Niagara Radio Supply	103
Oak Ridge Products	78
Opportunity Adlets	104
Perfection Electric Company	15
Pernix Corporation	105
Precision Apparatus Company	60
Pres-Probe Company*	93
Progressive Electronics	101
Quam-Nichols Company	82
RCA Victor Division (Radio Corporation of America)	Inside Front Cover, Back Cover
Radiart Corporation	65
Radio Apparatus Corporation	78
Radio City Products	94
Radio Corporation of America	20
Radio Dealers Supply	106
Radio-Electronics	99

RADIO SCHOOL DIRECTORY (Page 110)

Baltimore Technical Institute	Martin School, Don
Candler System Company	Milwaukee School of Eng.
Commercial Radio Institute	RCA Institutes
Electronics Institute, Inc.	Radio-Television Inst.
Hollywood Sound Institute	Tri-State College
Hollywood Tech. Institute	Valparaiso Technical Inst.
Indiana Technical Institute	YMCA Trade & Tech. Inst.

Radio Specialty Company

Raytheon Manufacturing Company 97
Rider, Inc. John F. 77
Rinehart Books, Incorporated 66
Sams & Company, Inc., Howard W. 14, 80, 92, 112
Six-Thirty (630) Dist. 112
Solo Elec. Sales Corporation 102
Soundtronics Laboratories 104
Sprague Products Company 4
Standard Coil Products 7
Standard Transformer Corporation 76
Steve-EI Electronics Corp. 91
Supreme Publications 21
Sutton's Wholesale Electronics, Bill 104
Sylvania Electric Products 59
Tab 112
Technical Radio Parts 89
Tel-A-Ray Enterprises, Incorporated 83
TV Communications Institute 83, 93
Television Materials, Incorporated 102
Thomas Electronics 79
Thomas Mold and Die Co. 109
Trio Manufacturing Company 10
Tung-Sol Lamp Works, Inc. 10
Up-State Distributors 111
Veri Best Television Products, Inc. 57
Ward Products 93
Weller Electric Corporation 64
Wells Sales Company 114
Wholesale Radio Parts Company 106

Radio-Electronics does not assume responsibility for any errors appearing in above index.

read about
"Experiments
in Audio"
you'll find it in
PF INDEX
GET YOUR
FREE COPY FROM
YOUR PARTS JOBBER

VEE-D-X for the finest LIGHTNING ARRESTERS at the Lowest Prices



New!
2-WIRE RW-200
only **125** LIST

The new VEE-D-X Model RW-200 is the popular low-priced arrester. Similar in design and construction to the RW-204. Two saw tooth contact points assure positive protection for any 2-wire installation.

4-WIRE RW-204
only **150** LIST

The first and only arrester that will accommodate 4-wire rotator line as well as regular 2-wire transmission line.



The Original 2-Wire RW-300

For use with 2-wire standard transmission line. An air gap plus resistor provide double protection. RW-300 is manufactured of moisture resistant Mica-fill Bakelite. RW-300A—highest quality thermo-setting plastic.



only **200** LIST

LA POINTE-PLASCOMOLD CORP., WINDSOR LOCKS, CONN.

FREE TV SERVICE CONTRACT

With every 1951 Model 630 Super-Chassis bought from The 630 Distributors Company, a FREE 30 DAY SERVICE CONTRACT is included (excluding shipping charges).

R.C.A. LICENSED 1951 MODEL 630 SUPER-CHASSIS \$159.95

Buy the famous 630 chassis with all 1951 improvements, designed for 16"-20" pictures. **HIGHER BRIGHTNESS**—with new higher voltage Flyback Circuit. **HIGHER CONTRAST RANGE**—with new Keyed AGC circuit. **HIGHER SENSITIVITY**—the best TV set yet for Fringe Reception. **HIGHER DEFINITION & CLARITY**—with new wide-band 4 1/2 Mc. video circuits. **STEADY PICTURES**—with new RCA licensed Sync circuits. **HIGHER FIDELITY**—with TRUE FM sound and 12" speaker. **LOWER PRICE**—because you buy direct from the distributor. All 1951 Model 630 Super-Chassis are tested for 5 hours before shipment. All tubes and parts are guaranteed for 90 days. Complete—ready to play—including Free 30 Day Service Contract—

\$159.95
less picture tube

NEW PICTURE TUBE SPECIALS

6 Months Guarantee—Standard Brands
Glare Free-Black Face Type

16" Rect or Round	\$38.45
17" Rect	41.95
19" Round	69.75
20" Rect	69.95

BEAUTIFUL TELEVISION CABINETS

Especially designed to fit the 630 Chassis

TABLE MODEL—16" or 17"—Walnut or Mahogany	\$47.35
TABLE MODEL—19" or 20"—Walnut or Mahogany	\$2.95
CONSOLETT—Floor Model—16" or 17"—Walnut or Mahod	57.45
CONSOLETT—Floor Model—19" or 20"—Walnut or Mahod	62.95
FULL DOOR CONSOLE—16" or 17"—Walnut or Mahogany	66.75
FULL DOOR CONSOLE—19" or 20"—Walnut or Mahogany	91.85

SHIPMENT MADE WITHIN 24 HOURS—ORDER AT ONCE!!

630 DISTRIBUTORS

725 Sutter Avenue Brooklyn 7, New York
APplegate 7-8580

IF YOU BUY ON SPECIFICATIONS



and tops in value, you'll buy the

TWIN-TRAX* TAPE RECORDER
"Choice of Engineers Everywhere"

Compare the guaranteed specifications of a Twin-Trax Tape Recorder with any other recorder in any price class. You'll find that Twin-Trax gives you more features, better all-around performance and more value for your money. Complete specifications, performance ratings and direct factory prices in our catalog 5109. Send for it today.

*Trademark Reg.

AMPLIFIER CORP. of AMERICA

398 Broadway, New York 13, N. Y.

TELEVISION RECEIVER—\$1.00

Complete instructions for building your own television receiver. 16 pages—11"x17" of pictures, pictorial diagrams, clarified schematics. 17"x22" complete schematic diagram & chassis layout. Also booklet of alignment instructions, voltage & resistance tables and trouble-shooting hints.—All for \$1.00. Write for free catalogue.

CERTIFIED TELEVISION LABORATORIES
Dept. C, 5507-13th Ave., Brooklyn 19, N. Y.

THE RADIUM
ATOMIC
SPINTHARISCOPE

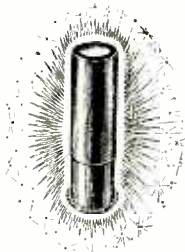

THE SPINTHARISCOPE is one of the most amazing scientific instruments ever invented. The SPINTHARISCOPE demonstrates that radium actually destroys atoms. Look into the SPINTHARISCOPE and you see a whole firmament lit up like a brilliant night sky. You observe thousands of "stars" and unfold bright flashes similar to showers of shooting stars.

Every flash is the result of the destruction of one atom of radium. These fast moving Helium atoms (also called Alpha rays) produce a minute flash of light when they strike a crystal of zinc sulphide contained in the SPINTHARISCOPE. The magnifying lens of the instrument makes these flashes visible to your eye. The action keeps on going for over 1800 years. Our SPINTHARISCOPE actually contains a small quantity of radium. If you want to see a most awe-inspiring sight, witness the actual destruction of thousands of worlds (atoms are miniature worlds), by simply looking through the lens of the instrument.

See RADIUM DISINTEGRATED AND DESTROYED RIGHT BEFORE YOUR EYES!

The RADIUM SPINTHARISCOPE
Item No. 190
Price, Postpaid 75c
HUDSON SPECIALTIES
CO., 40 West Broadway,
New York 7, N. Y.

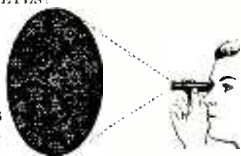

GREYLOCK TUBES
MORE THAN 400 TYPES LISTED

We're STILL DELIVERING
Better than 90%!

Complete stocks of Standard Brand Lines, including
AMPERITE—Microphones
EICO—Instrument Kits
XCELITE—Tools
EBY—Parts
WALSCO—Chemicals & Tools
HOWARD SAMS—Photofacts
TV Antennas & Accessories.
Write TODAY for our Complete Catalog.

GREYLOCK ELECTRONICS
SUPPLY CO.

115 Liberty Street Dept. C-4 New York 6, N. Y.

PRINCIPLES AND APPLICATIONS OF WAVEGUIDE TRANSMISSION, by George C. Southworth. Published by D. Van Nostrand Company, Inc. 6 1/2 x 9 inches, 689 pages. Price \$9.50.

It is hardly necessary in reviewing this book to do more than mention the author's name. Southworth is the pioneer student of waveguide phenomena, and is personally responsible for a major part of its development and application. His work will therefore no doubt be used as the standard text.

The first five chapters present a theoretical discussion of waveguide theory in higher mathematical terms. Chapter six gives the same material in descriptive terms that anyone with a basic knowledge of electricity can easily follow. Practical circuits and systems are discussed in the remaining six chapters, and these present much material of value for both the engineer and the non-mathematical technician.

RAPID TV TROUBLE SHOOTING METHOD, by H. G. Cisin. Published by H. G. Cisin, Brooklyn, N. Y. 8 1/2 x 11 inches, 23 pages. Price \$1.00.

This brochure describes a speedy and efficient method of locating the source of 114 different troubles in TV sets. Troubles are located by following three basic steps. The first is to classify the effect of the trouble on the picture, raster, and sound. Approximately 74 symptoms are listed for picture, 58 for raster, and 17 for sound troubles. These separate groups of symptoms are listed in alphabetical order and each is assigned a code number. The code numbers are combined to develop a code designation. All possible code designations are listed in a table with corresponding classification codes which show the part or parts of a given circuit can produce the particular trouble.

The second step involves the application of one or more of 13 checks to the defective section of the receiver.

Step 3 is used on complicated jobs where the trouble may be caused by two or more separate defects. It consists of a number of rapid checks which are used to analyze, sub-classify, and diagnose the trouble in the shortest time.

No circuit diagrams are provided but there are a number of oscillographic waveforms which will prove useful when working in sweep circuits and in making over-all alignment checks.



"What good is it, Professor—to invent the world's smallest radio tube when you can't find it?"

Suggested by Michael Modrick, Flushing, L. I.

NOW! BECOME EXPERT AT
RADIO-TELEVISION
IN 4 EASY STEPS!

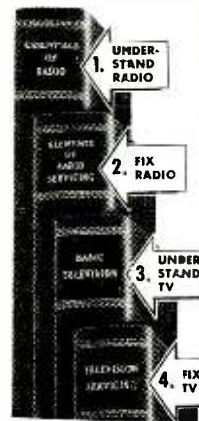

Complete Self-Training Course in RADIO and TV by Famous Experts—Takes You BY SIMPLE STEPS From Basic Theory to Problems of Repair, Installation, Color TV, etc.

NOW you can do ANY Radio-TV installation, service, or repair job like an expert; operate field-testing equipment; understand problems of TV, FM-AM transmission, etc. Step into a good-paying job—or start your own service business. Train yourself AT HOME... IN SPARE TIME... with the McGraw-Hill Basic Course in Radio and TV.

2296 Pages—1611 Illustrations

Complete 4-volume course by outstanding experts. Every detail clearly explained. Over TWO THOUSAND PAGES of step-by-step instruction, SIXTEEN HUNDRED "how-to-do-it" illustrations, cross-section diagrams, etc. "Trouble-shooting" charts show how to diagnose any radio or TV breakdown, how to repair it expertly and quickly.

Pays for itself many times over. Can qualify a beginner for FCC's 1st-Class License test; shows experienced technician new tricks.

SEND NO MONEY
Mail coupon to examine complete four-volume course FREE for 10 days. No obligation. WITH course, you get ABSOLUTELY FREE (to keep whether or not you keep course) valuable illustrated book, "Successful Soldering." (Reg. price: \$2.00)

Or you may examine individual books FREE for 10 days by checking proper boxes in coupon. Mail coupon at once!

PARTIAL CONTENTS
ESSENTIALS OF RADIO.
800 pages, 433 illus.
Circuit Analysis • Vacuum Tubes • Circuits: Detector • Amplifier • Tube Oscillator • Power Supply • Transmitting Receiver • Etc.
ELEMENTS OF RADIO SERVICING.
475 pages, 375 illus.
Multimeters • AC Power Supply • Speakers • Antennas • Auto Radios • Push-Pull Output Stage
BASIC TELEVISION.
592 pages, 415 illus.
Scanning • Synchronizing • Video Signal • Brightness Control • D-C Reinsertion • Picture • FM Alignment • Picture Tubes • VHF and UHF transmission • Reception
TELEVISION SERVICING.
429 pages, 388 illus.
Antennas • Transmission Lines • Test-pattern and Picture Analysis • Localizing Reception Troubles • Interference Remedies • Deflection Circuits
AND MUCH MORE!

FREE 10-DAY TRIAL COUPON

McGRAW-HILL BOOK CO., Inc., Dept. RE-4, 327 West 41st St., New York 18, N. Y.

Send me for 10 days' FREE EXAMINATION:
 McGRAW-HILL's Basic Course in Radio & TV... including Essentials of Radio, Elements of Radio Servicing, Basic Television, Television Servicing (Total retail price of four books \$22.50—Special Course Price: Only \$19.95 in easy installments). Also send, ABSOLUTELY FREE, "Successful Soldering." If not satisfied, I will return books; pay nothing; and keep "Successful Soldering" free. Otherwise, I will send only \$1.95 plus postage then; and balance in 6 monthly installments of only \$3.00 each.

If you wish to examine books individually, check below the ones you wish for 10 days' FREE EXAMINATION:

Essentials of Radio, \$6.00
 Elements of Radio Servicing, \$4.50
 Basic Television, \$6.50
 Television Servicing, \$5.50

For each book I keep, I will send \$2.00, plus postage, within 10 days; balance in easy monthly installments.

Name.....
Address.....

City..... State..... RE-4

WE PAY POSTAGE if you enclose first payment of \$1.95 when ordering course, or full price of book when ordering individual books (price above). Same 10-day Return-Refund Privilege

Special Relays - OVER A MILLION IN STOCK!

Whether you require large quantities of relays for production runs or single units for laboratory or amateur work, Wells can make immediate delivery and save you a substantial part of the cost.

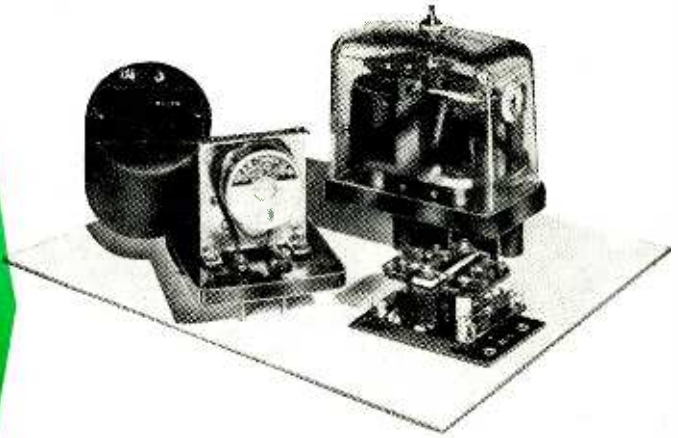

This list represents only a few types of Special Relays. We also have huge stocks of Standard D.C. Telephone Relays, Midget Relays, Contactors, Keying Relays, Rotary and Slow Acting Types as well as many others. Write or wire us about your requirements.

STOCK NO.	VOLTAGE	OHMAGE	CONTACTS	MANUFACTURER & NUMBER	PRICE
R-503	12/32 VDC.	100	3A, 2C	G.E. Ant. Keying 500W 2C6530-653AR1	\$ 2.25
R-749	600 VDC.	...	Max. 28 Amps.	Allen Bradley 810 Dashpot	5.95
R-804	550 VAC.	...	1B/38 Amps.	Culter Hammer C-261173A34 Contactor	3.50
R-250	115 VAC.	...	Adj. Cir. Breaker .04-.16A	Westinghouse MN Overload	12.95
R-579	220 VAC.	...	1B	Adlake 60 Sec. Thermo Delay	6.95
R-294	27.5 VDC.	200	1B	Edison 50 Sec. Thermo Delay	4.25
R-686	115 VAC.	...	2C	Leach 1157T-5/20 Sec. ADJ. Delay	4.95
R-246	115 VAC.	...	1B	Cramer 2 Min. Adj. Time Delay	8.95
R-246A	115 VAC.	...	1A	Cramer 2 Min. Adj. Time Delay	8.95
R-611	24 VAC.	...	1A/30 Amps.	Durakool BF-63	4.25
R-283	12 VDC.	125	AC/10 Amps.	Onan Rev. Current 3H4512, R24	1.00
R-614	18/24 VDC.	60	1A/15 Amps.	Rev. Current Cutout 3H2339A/E1	3.50
R-262	200	1C	W. U. Tel. Co. 41C Single Current	3.75
R-245	12 VDC.	25	4 In. Micalox Lever95
R-527	6/12 VDC.	50/50	1n Series	227668 For Scr-274N	.95
R-544	12/24 VDC.	60/60	1C	G.E. Push Button Remote Relay #CR2791-R-106C8	1.65
R-255	1A	G.E. Pressure Switch #2927B100-C2	.95
R-669	75 VAC.	400 CYC.	1B, 1A	Clare 400	.95
R-660	6 VDC.	3/8" Stroke	Cannon Plunger Relay #13672	.95
R-651	24 VDC.	100	Solenoid Valve	2.50
R-295	12 VDC.	275	Annunciator Drop	2.15
R-230	5/8 VDC.	2	2A, 1C	Guardian Ratchet Relay	2.15
R-813	12 VDC.	12	Wafer	Ratchet Relay From Scr-522	4.25
R-275	12 VDC.	750	1A, 1B, 1C	Guardian BK-10	2.75
R-716	24 VDC.	70	2A/5 Amps.	BK-13	1.45
R-620	6/12 VDC.	35	2C, 1A	Guardian BK-16	1.05
R-629	9/14 VDC.	40	1C/10 Amps.	Guardian BK-17A	1.25
R-778	8 VDC.	4500	1C/5 Amps.	Kurman BK-24	2.10
R-720	24 VDC.	50	2C, Ceramic	45A High Power	1.35
R-500	12 VDC.	10/10	2C/6 Amps.	Str. Dunn. Latch & Reset	2.85
R-816	12 VDC.	10/15	2C/6 Amps.	Guardian Latch & Reset	2.85
R-811	48 VDC.	8000	1C	Sigma 4R	1.65
R-524	24 VAC/DC.	Edwards Alarm Bell	.95
R-838	90/120 VDC.	925	2A	Allen Bradley-Bulletin #702	4.50
R-839	100/125 VDC.	1200	3A	Motor Control	4.50
R-840	115 VDC.	1200	2A	Allen Bradley-Bulletin #200E	4.50
R-841	115 VDC.	1200	4A	Motor Control	5.50
R-842	115 VDC.	925	3A	Allen Bradley-Bulletin #209 Size 1	25.00
R-843	115 VDC.	1200	3A	Motor Control W/Type "N" Thermals	5.50
R-844	115 VDC.	1200	3A, 1B	Allen Bradley-Bulletin #709 Size 2	5.50
R-845	220 VAC.	Intermit.	3A	Motor Control W/Type "N" Thermals	4.50
R-831	7.5/29 VDC.	6.5	1A/250A, 1000A Surge	Allen Bradley-Bulletin #200	4.50
R-837	110 VAC.	2A/30 Amps.	Motor Control	4.50
R-835	24 VDC.	2800	1A Dble. Brk./10 Amps.	Allen Bradley-Bulletin #202	4.50
R-836	220 VAC.	2A Ddle. Brk./10 Amps.	Motor Control	4.50
R-566	115 VAC.	(Coil only, Not a complete relay)	Allen Bradley-Bulletin #704	4.50
R-710	150-Ohms. Coil Only	Motor Control	4.50

Wide Selection of Electronic Components at WELLS

- Tubes
- Resistors
- Condensers
- Wire & Cable
- Volume Controls
- Co-ax Connectors
- Relays
- Rectifiers
- Transformers and Chokes
- Micro Switches and Toggles
- Antennas and Accessories
- Electronic Assemblies
- Dial Light Assemblies

NOTICE!

Although our offices and showrooms were recently destroyed by fire, we are conducting business as usual from our new address.

Write For New Wells Catalog

Each relay is new, individually boxed, and unconditionally guaranteed by Wells



TELEPHONE: SEeley 8-4143

833 W. CHICAGO AVE., DEPT. Y, CHICAGO 22, ILL.

You wouldn't risk your business on the turn of a card

... but a survey of hundreds of servicemen shows that 57% order capacitors by rating, without specifying a brand. Why risk your reputation on parts that may not deliver top performance?



Make Sure! Make it Mallory!

You'll get top performance every time you make it a Mallory Capacitor . . . top performance that stems from uniform capacity, long life, and outstanding service at high temperatures and heavy ripple currents.

Mallory produced the first dry electrolytic capacitor and has led the way in setting new standards for smaller sizes, uniform mounting, and resistance to heat in continuous service. Every Mallory FP assures you of trouble-free service, cuts down on comebacks.

MALLORY PLASCAP



The plastic tubular specifically designed to meet your field service problems. Available in a complete range of ratings.

You will like the Mallory Plascap*, plastic tubular capacitor, too! Ruggedly molded and securely sealed . . . it has clearly identified, permanently fastened leads, and stands up under high temperatures.

Don't be satisfied with less than the best. It costs no more to get the top performance that only Mallory Capacitors can give you!

**Trade Mark*

Depend on your Mallory Distributor for precision quality at competitive prices



P. R. MALLORY & CO. Inc. MALLORY

CAPACITORS • CONTROLS • VIBRATORS • SWITCHES • RESISTORS
• RECTIFIERS • VIBRAPACK* POWER SUPPLIES • FILTERS

*Reg. U.S. Pat. Off.

APPROVED PRECISION PRODUCTS

P. R. MALLORY & CO., Inc., INDIANAPOLIS 6, INDIANA

THE QUALITY OF RCA TUBES IS UNQUESTIONED



Extra Performance

as a matter of course...with RCA tubes

Engineering progress is part and parcel of RCA quality. For instance... many of the popular RCA types use "inverted" pinched cathodes to minimize microphonics by preventing cathode vibration or displacement.

This improved performance is achieved by clamping the top mica firmly between an embossed bead on the cathode and its pinched top end. This arrangement holds the upper end of the cathode rigidly, but per-

mits the heated cathode to expand freely downward through the bottom mica without producing cathode strain. The lower end of the cathode is prevented from vibrating by means of the damping tab connected between the cathode and stem lead.

This example is another reason why you can count on *extra* performance and long life from RCA tubes—the quality tubes.

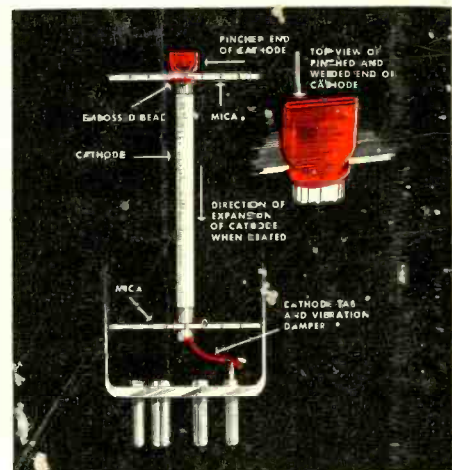

Keep informed—stay in touch with your RCA Tube Distributor



RADIO CORPORATION of AMERICA
ELECTRON TUBES
HARRISON, N. J.

ADV Plans, LLC

Copyright Notice:

The entire contents of this CD/DVD are copyright 2014 by ADV Plans, LLC. All Rights Reserved.

Reproduction or distribution of this disk, either free or for a fee is strictly prohibited. We actively monitor and remove listings on eBay thru Vero.

You are free to copy or use individual images in your own projects, magazines, brochures or other school projects.

Only the sellers listed here are authorized distributors of this collection:
www.theclassicarchives.com/authorizedsuppliers

Please view our other products at
www.theclassicarchives.com,
or our ebay stores:

[TheClassicArchives](#)
[ADVPlans](#)
[SuperShedPlans](#)

